

WHITE beet E module is intended to add full ISO/IEC 15118 functionality to any existing AC-wallbox, AC charging stations or provide this functionality to pure DC charging stations as well as to existing Combined Charging Systems (CCS) to bring down system cost. The module contains coupling transformer with 1:1:1 winding ratio, zero-cross (ZC) analogue and digital inputs, PWM control pilot generation circuit.

**Available for purchase from CODICO GmbH*

WHITE beet E module provides the necessary hardware to support ISO 15118-3 HomePlug GreenPHY powerline communication over Control Pilot (CP) wire and Protective Earth (PE). The module includes STM32 MCU for executing the ISO/IEC 15118 / DIN 70121 / SAE J2847/2 software stack on it, use Ethernet and SPI as Host Control interfaces as well and Control Pilot for PLC communication.

In addition WHITE beet E module provides IEC 61851-1 / SAE J1772 PWM generation and detection functionality on EVSE side.

Contents

1. Features	3
2. Block diagram	4
3. Operational conditions	5
4. Module pinout and pin description	6
5. Reference design schematics	10
6. Module marking information	11
7. Mechanical characteristics	12
8. Reflow profile information	14
9. Evaluation board	15
10. Packaging and ordering information	16
11. Document revision history	17

1. Features

WHITE beet E module comes in three software configurations:

- E-mobility Bridging/SLAC software as a closed system
- E-mobility ISO 15118 / DIN 70121 / SAE J2847/2 stack software as a closed system
- E-mobility SDK Open (no embedded firmware)

E-mobility transparent bridging/SLAC software

Allows Ethernet frames bridging between Ethernet / SPI interface interfaces and powerline, as well as processing a SLAC exchange mechanism. System is closed, so customer cannot add any own application software.

E-mobility ISO 15118 / DIN 70121 / SAE J2847/2 stack software

Software stack supports V2G EMI (Vehicle to Grid, External Identification Means), PnC (Plug & Charge), TLS 1.2, BPT (Bipolar Power Transfer). It includes ISO 15118-2 EMI and DIN 70121 / SAE J2847/2 software stack as well as all necessary network protocols and services. Host controller is accessible using Ethernet or SPI interface via API messages. System software is closed, so the customer cannot add any own applications.

OCPP 1.6 and 2.0 planned for the near future software releases.

E-mobility SDK Open (no embedded firmware)

Modules with "open" software option come not programmed. However, there is a SDK which allows developers to integrate their own applications into the module's STM32 MCU.

Both other software options can be available as a source code directly from our Software partner per request (is a subject to license fees to be agreed with the Software partner).

SDK software features include but not limited to QCA700x SPI driver, SLAC (to offload external host system from time critical real-time operations), ISO 15118-2, DIN 70121, PnC, SAE J2847/2 (future option), ISO 15118-20 (future option), TCP/IPv6, TLS, OCPP communication stacks (future option).

WHITE beet E module is based on Qualcomm QCA7005-AL33 HomePlug Green PHY automotive IC and together with its TCXO generator it makes possible operation temperature up to +105°C.

The other important key facts about the module:

- STM32F745VGH6 MCU with 1MB internal Flash
- 4MB external NOR Flash Memory on-board (3MB could be available for user applications)
- Ethernet / SPI host control interfaces
- UART debug output and configurable GPIOs
- Mains (110V / 240V) zero-cross (ZC) detection and digital input for ZC detection
- IEC 61851-1 / SAE J1772 PWM generation and detection
- Optimized low noise DC/DC power supply for QCA7005
- Very low noise floor implementation on PLC side providing a maximum of SNR for communication
- Optimized PLC line coupling and overvoltage protection circuitry to provide maximum SNR
- Operation board temperature range -40°C to +105°C
- Operation ambient temperature range (estimation) -40°C to +85°C

- TCXO generator 25.000 MHz, +/-25ppm tolerance including full operation temperature range and 15 years of aging
- Half via pins in order to allow optical inspection of the soldering of the module and higher mechanical stability for rough environments (e.g. heavy duty machinery)
- Separated dual, low ripple 3.3V DC/DC power supply for QCA7005 and STM32
- +/-12V DC/DC power supply for IEC 61851-1 / SAE J1772 PWM generation and detection
- Green PHY Firmware options by boot-straps for FW v1.1.0-02 and latest available firmware (currently FW v3.0)
- ARM Serial Wire Debug interface (SWD)
- 50 mm x 50 mm SMD package
- Weight 10.2±0.1 g

NOTE: This documents does not contain any WHITE-beet-E software features related information. Software documentation is provided separately.

2. Block diagram

FIGURE 3-1. WHITE-BEET-E (EVSE) BLOCK DIAGRAM

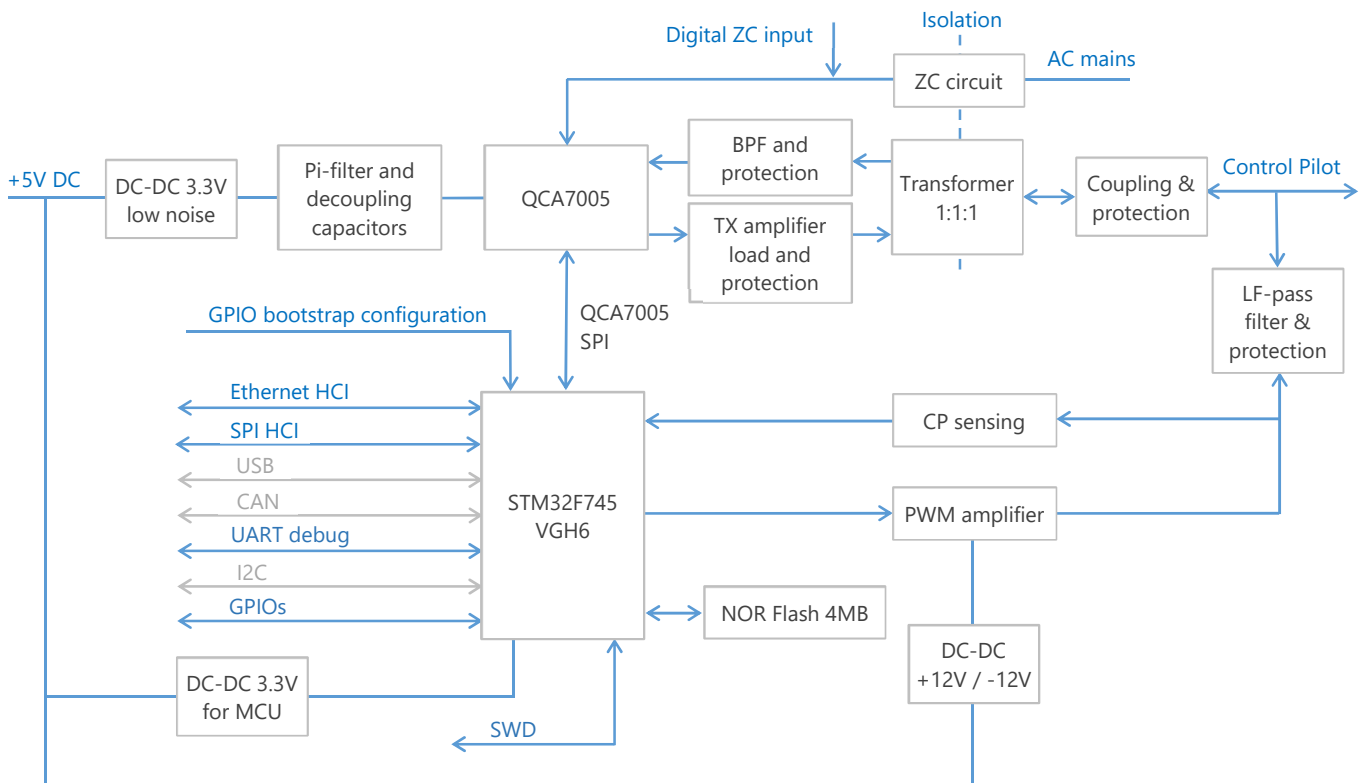

NOTE: HCI = Host Control Interface;
Interfaces which have grey text color are not supported in the software at the moment.

3. Operational conditions

TABLE 3-1. STANDARD OPERATING CONDITIONS

Parameter	Min	Typical	Max	Units
Power supply voltage (VDD)	4.9	5	5.2	V
GPIOs, communication interfaces input voltage	-	3.3	3.46	V
Power consumption (at +25 °C)	-	1	1.6	W
Operating (board) temperature	-40	-	+95	°C
Ambient temperature (approximation)	-40	-	+85	°C
Control Pilot voltage (CP)	-12	-	+12	V
AC mains voltage (ZC_LINE, AC_LINE)	-	240 120	-	V _{RMS}

TABLE 3-2. ABSOLUTE MAXIMUM CONDITIONS

Parameter	Min	Typical	Max	Units
Power supply voltage (VDD)	4.75	5	5.25	V
Power supply noise and ripples voltage	-	-	40	mV _{p-p}
GPIOs, communication interfaces input voltage	-0.3	-	3.6	V
Operating (board) temperature	-40	-	+105	°C
Storage temperature	-40	-	+150	°C
Control Pilot voltage (CP)	-13	-	+13	V
AC mains voltage (ZC_LINE, AC_LINE)	112	-	265	V _{RMS}
RESETN input pulse duration	0.3	-	-	µs

TABLE 3-3. ZERO-CROSS DETECTOR INPUT SPECIFICATION

Parameter	Min	Typical	Max	Units
ZC_LINE AC mains frequency (F)	48.4 57.7	50 60	51.6 62.3	Hz
Active high / low time	0.4 0.4	10.0 8.3	19.6 16.2	ms
Rise / fall time	0.001	-	-	ms
Offset from zero-crossing	0 0	- -	20.0 16.6	ms
ZC_DIGITAL pulse voltage	0.1	0.25	3.3	V _{p-p}

4. Module pinout and pin description

TABLE 4-1. WHITE-BEET-E MODULE PINOUT INFORMATION

Pin	WHITE-BEET-ES WHITE-BEET-EI	WHITE-BEET-EO	Main function type	Main function description
PAD 1	HEART-BEAT	HEART-BEAT / PC0	O	Heard-beat signal for LED
PAD 2	GND		-	Ground connection
PAD 3	ETH_MDC	ETH_MDC / PC1	O	Ethernet HCI MII Clock
PAD 4	ETH_MDIO	ETH_MDIO / PA2	I/O	Ethernet HCI MII Data
PAD 5	ETH_RXD0	ETH_RXD0 / PC4	I	Ethernet HCI MII Receive Data[0]
PAD 6	ETH_REF_CLK	ETH_REF_CLK / PA1	I	Ethernet HCI MII Receive Clock
PAD 7	ETH_RXD1	ETH_RXD1 / PC5	I	Ethernet HCI MII Receive Data[1]
PAD 8	ETH_CRS_DV	ETH_CRS_DV / PA7	I	Ethernet HCI MII Receive Data Valid
PAD 9	ETH_TXD1	ETH_TXD1 / PB13	O	Ethernet HCI MII Transmit Data[1]
PAD 10	ETH_TX_EN	ETH_TX_EN / PB11	O	Ethernet HCI MII Transmit Enable
PAD 11	ETH_TXD0	ETH_TXD0 / PB12	O	Ethernet HCI MII Transmit Data[0]
PAD 12	GND		-	Ground connection
PAD 13	ETH_RSTN	ETH_RSTN / PA6	I	Ethernet Chip Reset (active Low)
PAD 14	HCI_GPIO_27	PA3	I/O	HCI GPIO 27 controlled via API
PAD 15	RESERVED	PE7	I/O	PE7 pin of STM32F745 Connect to GND if not used or reserved
PAD 16	HCI_GPIO_26	PB0	I/O	HCI GPIO 26 controlled via API
PAD 17	HCI_GPIO_24	PB1	I/O	HCI GPIO 24 controlled via API
PAD 18	RESERVED	PE8	I/O	PE8 pin of STM32F745 Connect to GND if not used or reserved
PAD 19	HCI_GPIO_21	PE9	I/O	HCI GPIO 21 controlled via API
PAD 20	HCI_GPIO_20	PE11	I/O	HCI GPIO 20 controlled via API
PAD 21	RESERVED	PE13	I/O	PE13 pin of STM32F745 Connect to GND if not used or reserved
PAD 22	RESERVED	PE12	I/O	PE12 pin of STM32F745 Connect to GND if not used or reserved
PAD 23	RESERVED	PE10	I/O	PE10 pin of STM32F745 Connect to GND if not used or reserved
PAD 24	SPI_CLK	PD3	I	SPI HCI Clock
PAD 25	RESERVED	PB10	I/O	PB10 pin of STM32F745 Connect to GND if not used or reserved
PAD 26	RESERVED	PD8	I/O	PB8 pin of STM32F745 Connect to GND if not used or reserved
PAD 27	RESERVED	PE15	I/O	PE15 pin of STM32F745 Connect to GND if not used or reserved
PAD 28	RESERVED	PD9	I/O	PD9 pin of STM32F745 Connect to GND if not used or reserved
PAD 29	RESERVED	PD10	I/O	PD10 pin of STM32F745 Connect to GND if not used or reserved

TABLE 4-1 (CONTINUATION). WHITE-BEET-E MODULE PINOUT INFORMATION

Pin	WHITE-BEET-ES WHITE-BEET-EI	WHITE-BEET-EO	Main function type	Main function description
PAD 30	RESERVED	PD15	I/O	PD15 pin of STM32F745 Connect to GND if not used or reserved
PAD 31	RESETN		I	Module Reset (active Low)
PAD 32	BS_1		I	QCA7005 FW and PIB version selection ("H" = v3.0, "L" = v1.1.0-02) Has internal pull-down resistor 10k Ohm
PAD 33	+5V		-	5V power supply
PAD 34	GND		-	Ground connection
PAD 35	SPI_MISO	SPI2_MISO / PB14	O	SPI HCI Master-Input/Slave-Output
PAD 36	SPI_MOSI	SPI2_MOSI / PB15	I	SPI HCI Master-Output/Slave-Input
PAD 37	SPI_RX_READY	PD4	O	SPI HCI Slave is ready
PAD 38	SPI_TX_PENDING	PD11	O	SPI HCI Slave transfer date is ready
PAD 39	GND		-	Ground connection
PAD 40	CAN_TX	CAN1_TX / PD1	O	CAN Transmit Data
PAD 41	CAN_RX	CAN1_RX / PD0	I	CAN Receive Data
PAD 42	CAN_INH	CAN1_INH / PC8	O	CAN Normal/Silent mode selection ("0" = Normal, "1" = Silent)
PAD 43	RESERVED	PC9	I/O	PC9 pin of STM32F745 Connect to GND if not used or reserved
PAD 44	RESERVED	PC7	I/O	PC7 pin of STM32F745 Connect to GND if not used or reserved
PAD 45	GND		-	Ground connection
PAD 46	USB_DN	USB_DN / PA11	I/O	USB Data Negative Signal
PAD 47	USB_DP	USB_DP / PA12	I/O	USB Data Positive Signal
PAD 48	GND		-	Ground connection
PAD 49	RESERVED	PA9	I/O	PA9 pin of STM32F745 Connect to GND if not used or reserved
PAD 50	RESERVED	PA10	I/O	PA10 pin of STM32F745 Connect to GND if not used or reserved
PAD 51	BOOT		I	Boot memory selection (used for SW development, please connect to GND)
PAD 52	SWDIO		I/O	Serial Wire Debug Data
PAD 53	SWCLK		I	Serial Wire Debug Clock
PAD 54	RESERVED	PC12	I/O	PC12 pin of STM32F745 Connect to GND if not used or reserved
PAD 55	NC		-	No connection on the module
PAD 56	NC		-	No connection on the module
PAD 57	CP			Control Pilot
PAD 58	CP			Control Pilot
PAD 59	PE			Protected Earth
PAD 60	PE			Protected Earth

TABLE 4-1 (CONTINUATION). WHITE-BEET-E MODULE PINOUT INFORMATION

Pin	WHITE-BEET-ES WHITE-BEET-EI	WHITE-BEET-EO	Main function type	Main function description
PAD 61		NC	-	No connection on the module
PAD 62		NC	-	No connection on the module
PAD 63		NC	-	No connection on the module
PAD 64		ZC_LINE	HV	AC mains LINE for zero-cross detector input Must be connected to GND when ZC_DIGITAL is used instead
PAD 65		NC	-	No connection on the module
PAD 66		NC	-	No connection on the module
PAD 67		NC	-	No connection on the module
PAD 68		ZC_NEUTRAL	HV	AC mains NEUTRAL for zero-cross detection
PAD 69		ZC_NEUTRAL	HV	AC mains NEUTRAL for zero-cross detection
PAD 70		NC	-	No connection on the module
PAD 71		ZC_DIGITAL	I	Digital zero-cross input. Has internal pull-up resistor 40k Ohm. Must be left not connected (NC) when not used
PAD 72	I2C_SDA	I2C1_SDA / PB7	I/O	I2C Serial Data
PAD 73	HCI_GPIO_22	PD5	I/O	HCI GPIO 22 controlled via API
PAD 74	HCI_GPIO_23	PD7	I/O	HCI GPIO 23 controlled via API
PAD 75	UART_RX (debug)	UART8_RX / PE0	I	UART Receive Data
PAD 76	UART_TX (debug)	UART8_TX / PE1	O	UART Transmit Data
PAD 77	SPI_NSS	SPI2_NSS / PB9	I	SPI Slave Select (active Low)
PAD 78	I2C_SCL	I2C1_SCL / PB8	O	I2C Clock
PAD 79	HCI_GPIO_25	PC13	I/O	HCI GPIO 25 controlled via API
PAD 80	RESERVED	PC14	I/O	Reserved for further software features Connect to GND if not used or reserved
PAD 81	RESERVED	PC15	I/O	Reserved for further software features Connect to GND if not used or reserved
PAD 82	AIN_0	PA5	I/O	Reserved for further software features Connect to GND if not used or reserved
PAD 83	RESERVED	PC3	I/O	Reserved for further software features Connect to GND if not used or reserved
PAD 84	IF_SELECT_1	PA4	I/O	HCI interface selection pin 1 should be always "0"
PAD 85	IF_SELECT_0	PC2	I/O	HCI interface selection pin 0 "0"=Ethernet, "1"=SPI
PAD 86		THERMAL PAD	-	Thermal pad, has to be connected to GND

NOTE: 1) Pins marked as RESERVED are STM32F745 GPIO reserved for future SW feature.
On WHITE-BEET-ES and WHITE-BEET-EI modules RESERVED should be connected to GND.
2) Pins with the same name (except RESERVED) have internal connection on the module.

IMAGE 4-1. MODULE PIN ASSIGNMENTS (BOTTOM VIEW)

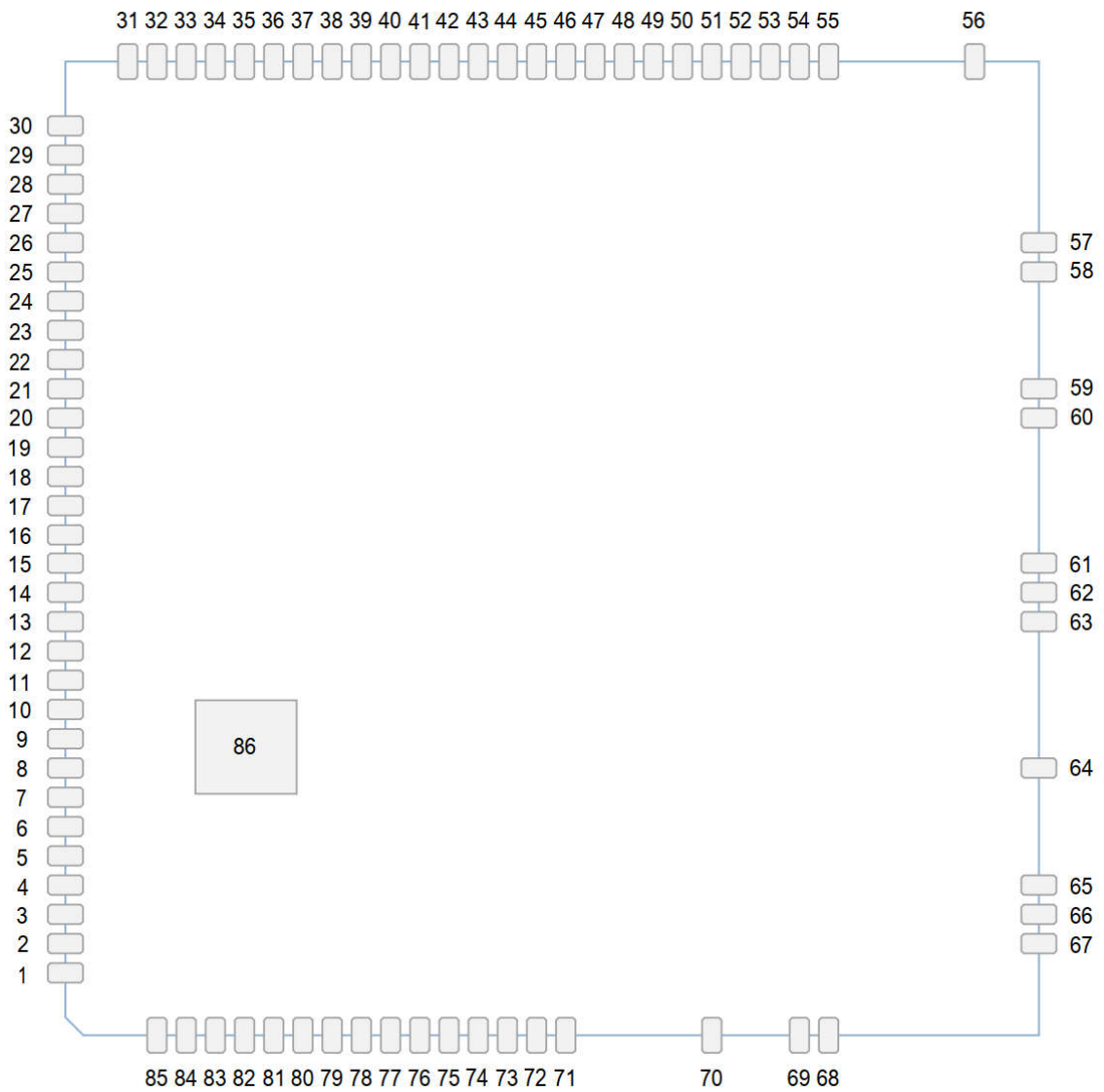

5. Reference design schematics

Please follow design recommendations given in the [WHITE-BEET reference design schematic](#) and [PLC Design Guide](#) documents in the PLC documentation area on <https://downloads.codico.com/misc/plc>

IMAGE 5-1. PLC DOCUMENTATION AREA LOGIN PAGE

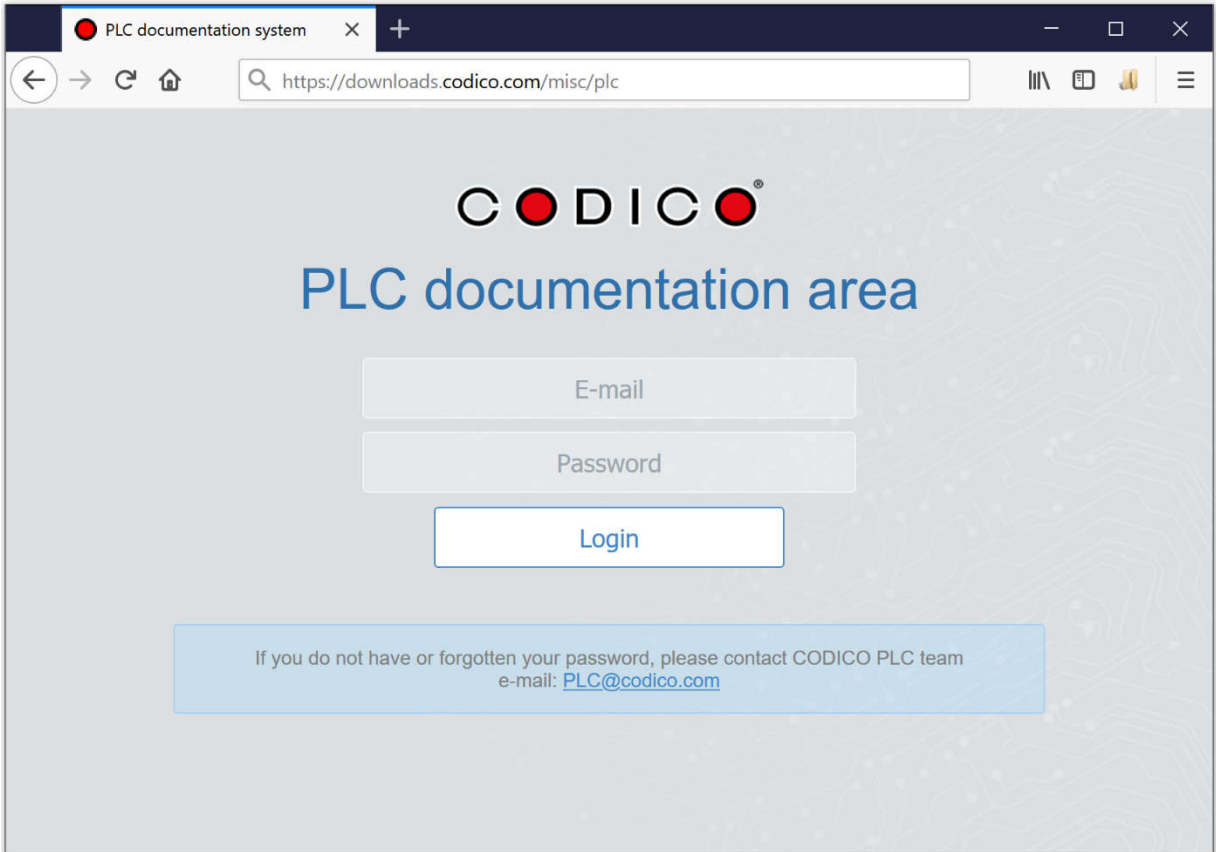

6. Module marking information



Each module is marked with a label containing the following data:

1. Ordering code
2. QCA7005 MAC Address (contains no separator, OUI C49300)
3. Serial Number in a format PWL600VWWYYNNNNNN, where:
 - PWL600 - product code for WHITE beet
 - V - module configuration:
 - 1 for WHITE-beet-H,
 - 2 for WHITE-beet-EO,
 - 3 for WHITE-beet-PO,
 - 4 for WHITE-beet-EI,
 - 5 for WHITE-beet-PI,
 - 6 for WHITE-beet-ES,
 - 7 for WHITE-beet-PS,
 - WWYY - data code as a calendar week of production followed by a year
 - NNNNNN - serial number in a production lot
4. QR-code containing MAC Address
5. Additionally each label contains 8Devices logo which also indicates pin 1 position

7. Mechanical characteristics

IMAGE 7-1. PIN DIMENSIONS (BOTTOM VIEW)

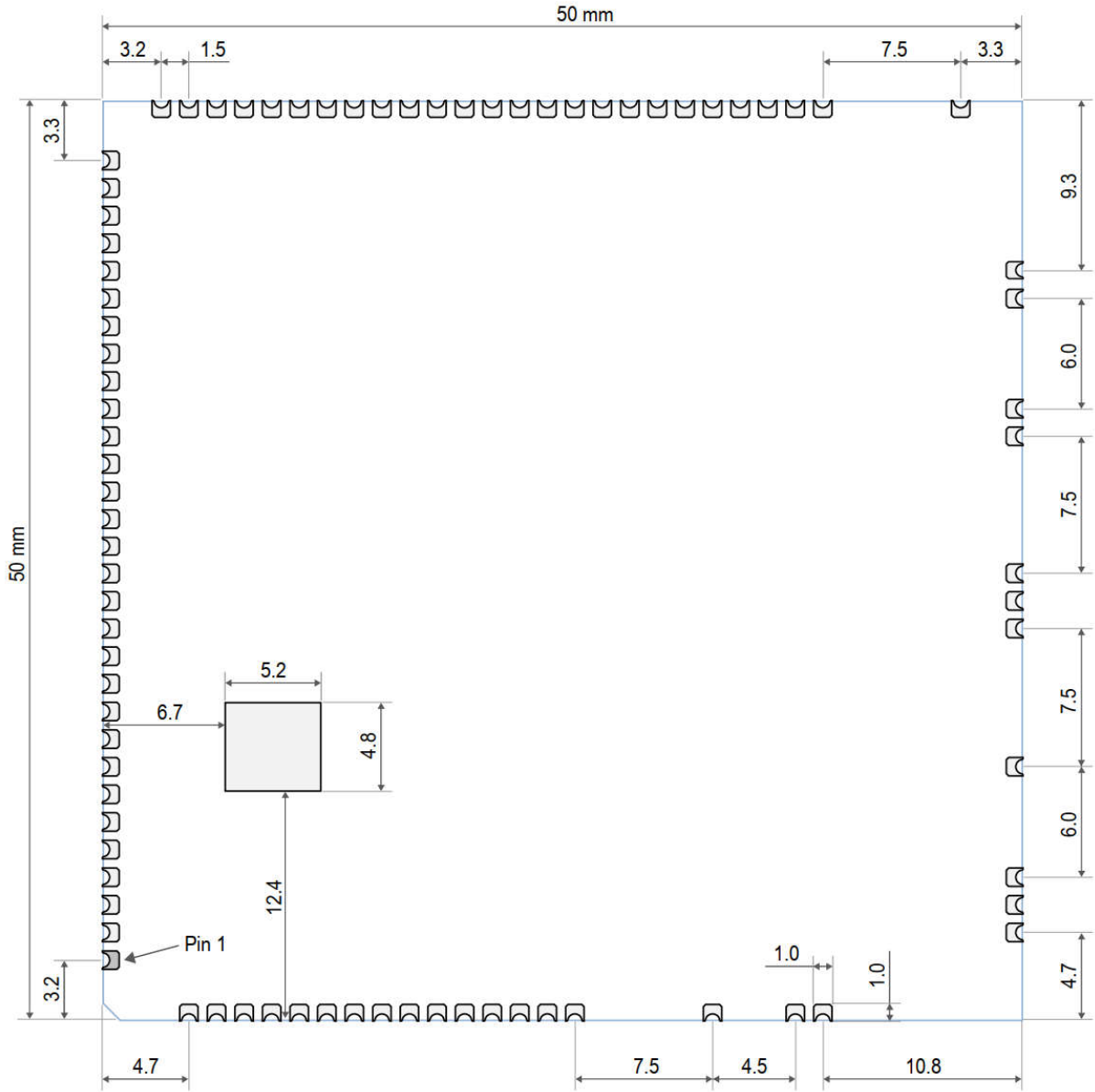

IMAGE 7-2. PCB FOOTPRINT (TOP VIEW)

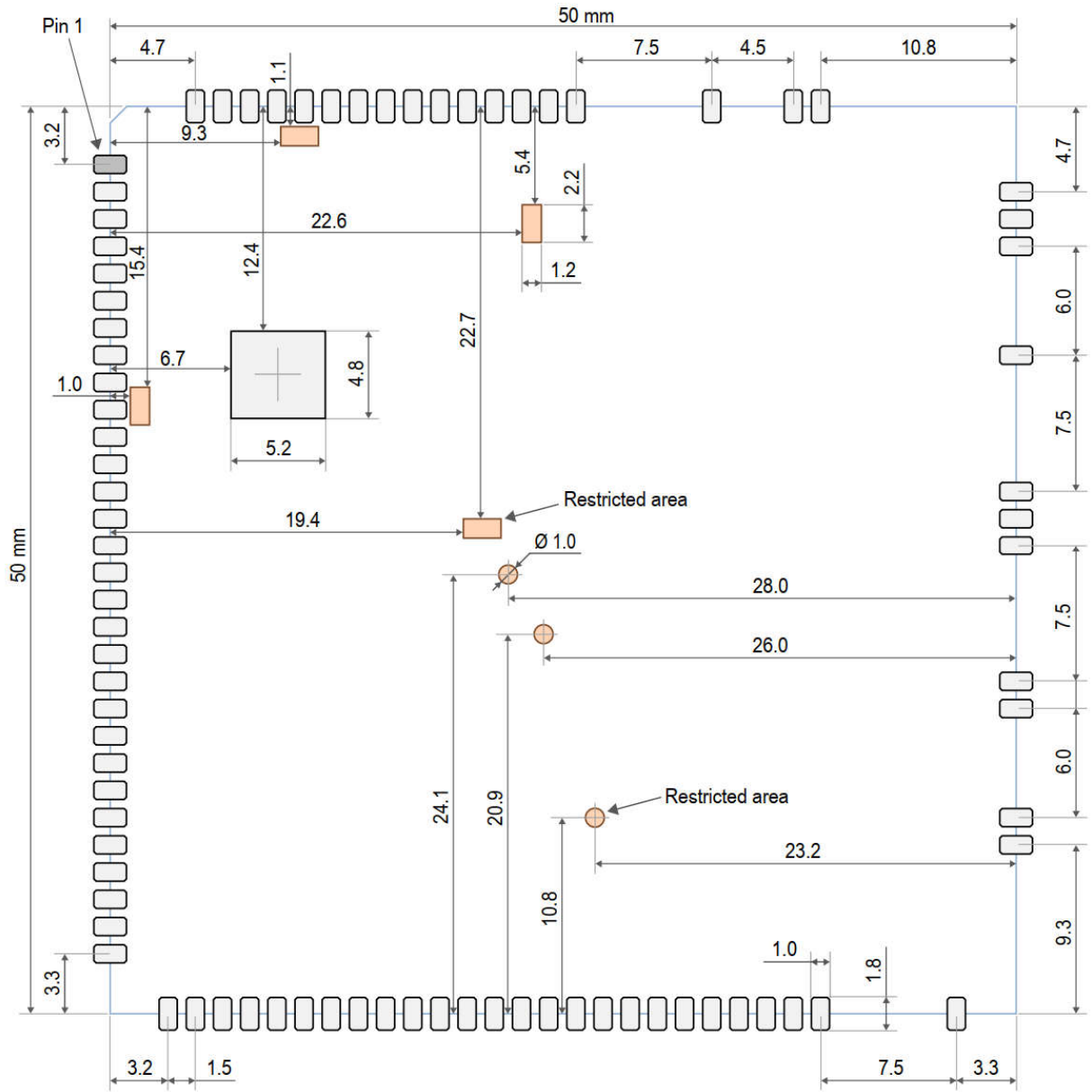
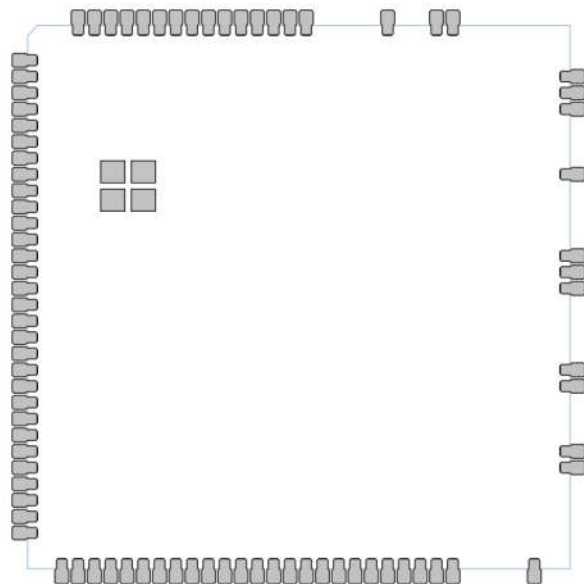

IMAGE 7-3. SOLDERING PASTE FOOTPRINT (TOP VIEW)



8. Reflow profile information

Reflow profile recommendation

Ramp up rate	3°C/second max
Maximum time maintained above 217°C	120 seconds
Peak temperature	250°C
Maximum time within 5°C of peak temperature	20 seconds
Ramp down rate	6°C/second max

Reflow profile

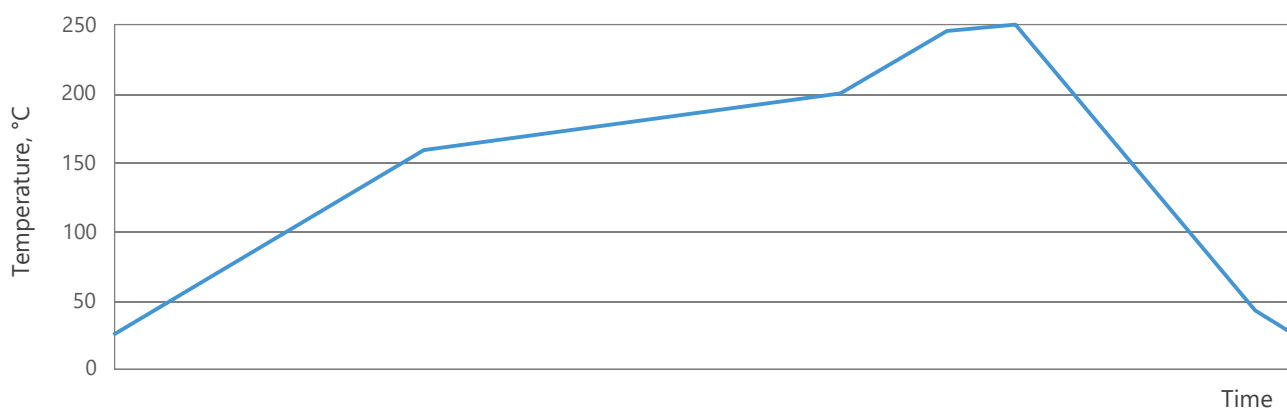

9. Evaluation board

WB-CARRIER-BOARD is an evaluation and development board for WHITE-beet modules. It contains WHITE-BEET module populated on the carrier board and protected with a plastic cover.

IMAGE 9-1. WB-CARRIER-BOARD (TOP VIEW)

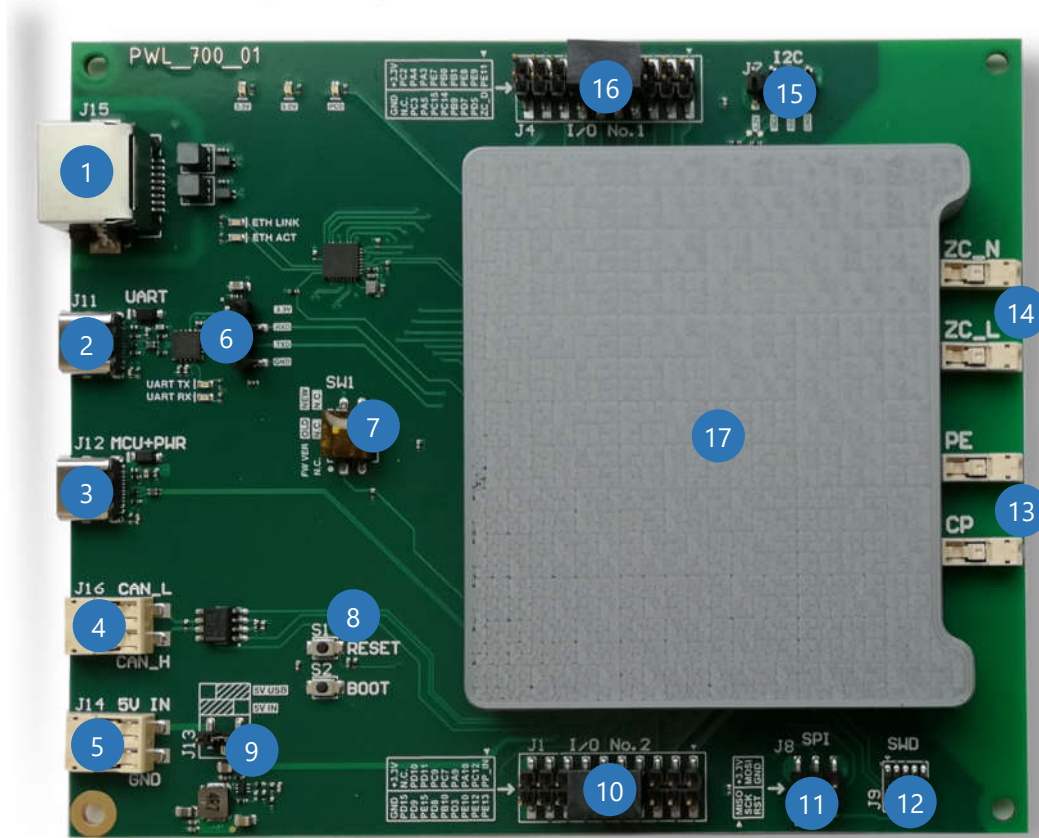

TABLE 9-1. WB-CARRIER-BOARD MAIN SECTIONS

Item number	Description
1	J15 Ethernet interface RJ45 connector
2	J11 USB-C connector for UART debugging console
3	J12 USB-C connector for +5V DC power supply and USB communication
4	J16 CAN interface connector
5	J5 Alternative +5V DC power supply connector
6	J10 4-pin UART debugging console header
7	SW1 Micro switch to select active QCA7005 firmware version
8	S1 RESET button and (S2) Boot button (required for software development)
9	J13 Jumper for +5V DC power supply source selection
10	J1 20-pin GPIOs header #2
11	J8 6-pin SPI interface header
12	J9 10-pin SWD interface header for programming and debugging
13	Control Pilot (CP) and Protected Earth (PE) connectors
14	Zero-cross input (ZC_L / ZC_N) connectors
15	J7 4-pin I2C interface header
16	J4 20-pin GPIOs header #1
17	Plastic cover for WHITE BEET module (placed for a safety reasons)

10. Packaging and ordering information

WHITE beet modules are packed into trays. Each tray fits 15 modules. Every 5 trays are vacuum sealed and one standard packing box contains 375 modules.

TABLE 10-1. MODULE ORDERING OPTIONS

Part number	Description
WHITE-BEET-ES #292206	EVSE side e-mobility HW with transparent bridging / SLAC software
WHITE-BEET-EI #292207	EVSE side e-mobility HW with ISO 15118 / DIN 70121 / SAE J2847/2 software stack (support of V2G, EMI, PnC, BPT)
WHITE-BEET-EO #292208	EVSE side e-mobility without embedded software included, SDK open option
WHITE-BEET-PS #292210	PEV side e-mobility HW with transparent bridging / SLAC software
WHITE-BEET-PI #295426	PEV side e-mobility HW with ISO 15118 / DIN 70121 / SAE J2847/2 software stack (support of V2G, EMI, PnC, BPT)
WHITE-BEET-PO #295427	PEV side e-mobility without embedded software included, SDK open option
WHITE-BEET-H #292209	Home control / smart grid HW with transparent bridging software

More PEV / EVSE - configured eMobility related products can be found in CODICO Sample Shop:

<https://www.codico.com/en/products/powerline-communication>

11. Document revision history

Revision	Revision Date	Description
0.2	2020.06.01	Product brief (preliminary information)
0.9	2020.11.05	Draft pre-release
1.00	2020.11.27	Customer release
1.01	2020.12.04	Figure 3-1, Table 4-1 and Table 10-1 correction
1.02	2021.07.28	Correction over all the chapters including block diagram and pin descriptions (Table 4-1).
1.02c	2022.06.30	Table 4-1, PAD32 correction

*** The confidential information is provided "as is". The discloser makes no representations or warranties, express or implied, with respect to the information, and disclaims all warranties including, without limitation, the warranties of merchantability, and fitness for a particular purpose. ***