

Overview

The FXQ series is constructed of Metallized Polypropylene Film encapsulated with self-extinguishing resin in plastic box of material meeting the UL 94V-0 requirements. The series are suitable for harsh environment condition and qualify in accordance to AEC-Q200D requirement.

Applications

Interference suppression, across-the-line capacitor, EMI filter and spark-killer in class X2 applications. Suitable for use in situations where failure of the capacitor would not lead to danger of electric shock.

Features

- High stability of capacitance
- High operating temperature: 110°C
- Self-healing property
- Over voltage stress withstanding
- Flame-retardant plastic case and resin
- Suitable for harsh environmental conditions
- THB 2000H - 85°C 85%RH, 2000 Hours, U_{RAC}
- Automotive Grade (AEC-Q200D)

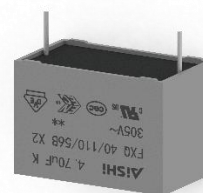

Approvals

Marking	Standard	File Number
	UL 60384-14 CAN/CSA-E60384-14	E500538 (305Vac~760Vac)
	IEC 60384-14:2013 IEC 60384-14:2013/AMD1:2016	40051583 (305Vac) 40052137 (350Vac~760Vac)
	IEC 60384-14 GB/T6346.14-2015	CQC20001245437 (305Vac) CQC20001281016 (350Vac~480Vac) CQC20001281018 (530Vac~760Vac)

Marking

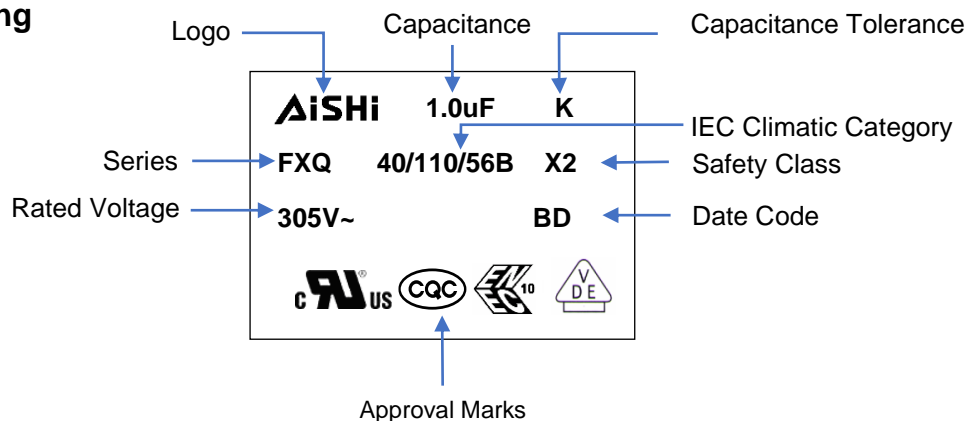

Manufacturing Date Code

Year	Code	Month	Code
2018	A	Jan	1
2019	B	Feb	2
2020	C	Mar	3
2021	D	Apr	4
2022	E	May	5
2023	F	Jun	6

Year	Code	Month	Code
2024	G	Jul	7
2025	H	Aug	8
2026	J	Sep	9
2027	K	Oct	A
2028	L	Nov	N
2029	M	Dec	D

Part Number System

F	XQ	30	K	105	G18	2GL	5
Capacitor Type	Series	Voltage (VAC)	Tolerance	Capacitance (pF)	Size Code	Terminal Code	Lead Length Code
F = Film	X2, AEC-Q200 Type, Metallized PP Film	30=305Vac 35=350Vac	K = ±10% M = ±20%	First two digits = significant figures. Third digit = Number of zeros.	Refer to Dimension Table	Refer to Terminal Code Table	Refer to Lead Length Table

Terminal Code

Digit One (Lead/Terminal Type)		Digit Two (Lead Space)		Digit Three (Lead Ipsilateral)	
2 leads for long	L	15.0mm	E	N/A	L
2 leads for straight cut	2	22.5mm	F		
2 leads for forming cut	E	27.5mm	G		
Taping	T	37.5mm	K		
Taping Straight	V	N/A	N		

Lead Length Code

Lead Length	
20mm min	L
3.5mm	2
3.0mm	3
4.0mm	4
5.0mm	5
7.0mm	7
Taping	T
N/A	N

Dimension (mm)

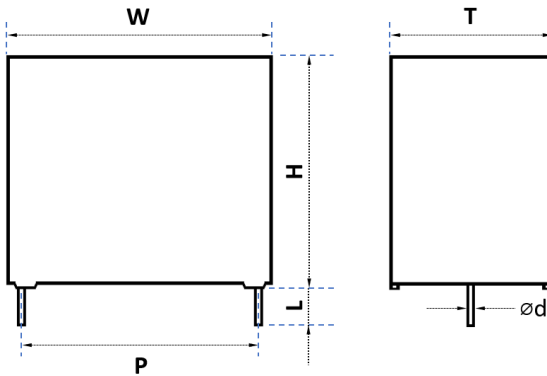

2 pins

Size Code Table (mm)

Size Code	Dimension						Pitch		Lead Wire	
	W	Tolerance	H	Tolerance	T	Tolerance	P	Tolerance	Ød	Tolerance
E14	18	0.5	11	0.5	5	0.5	15	0.5	0.6	0.05
E17	18	0.5	12	0.5	6	0.5	15	0.5	0.6	0.05
E18	18	0.5	13.5	0.5	6	0.5	15	0.5	0.6	0.05
E29	18	0.5	13.5	0.5	7.5	0.5	15	0.5	0.8	0.05
E34	18	0.5	14.5	0.5	8.5	0.5	15	0.5	0.8	0.05
E43	18	0.5	16	0.5	10	0.5	15	0.5	0.8	0.05
E47	18	0.5	19	0.5	11	0.5	15	0.5	0.8	0.05
F17	26	0.5	16.5	0.5	7	0.5	22.5	0.5	0.8	0.05
F20	26	0.5	17	0.5	8.5	0.5	22.5	0.5	0.8	0.05
F24	26	0.5	19	0.5	10	0.5	22.5	0.5	0.8	0.05
F26	26	0.5	20	0.5	11	0.5	22.5	0.5	0.8	0.05
F27	26	0.5	22	0.5	12	0.5	22.5	0.5	0.8	0.05
F29	26	0.5	23	0.5	13	0.5	22.5	0.5	0.8	0.05
F34	26	0.5	29.5	0.5	14.5	0.5	22.5	0.5	0.8	0.05
F36	26	0.5	25	0.5	15	0.5	22.5	0.5	0.8	0.05
G15	32	0.8	18	0.8	9	0.8	27.5	0.5	0.8	0.05
G18	32	0.8	20	0.8	11	0.8	27.5	0.5	0.8	0.05
G22	32	0.8	24.5	0.8	13	0.8	27.5	0.5	0.8	0.05
G25	32	0.8	24	0.8	14	0.8	27.5	0.5	0.8	0.05
G26	32	0.8	28	0.8	14	0.8	27.5	0.5	0.8	0.05
G33	32	0.8	28	0.8	18	0.8	27.5	0.5	0.8	0.05
G34	32	0.8	33	0.8	18	0.8	27.5	0.5	0.8	0.05
G40	32	0.8	37	0.8	22	0.8	27.5	0.5	0.8	0.05
K21	42	1.0	32	1.0	19	1.0	37.5	0.5	1.0	0.05
K24	42	1.0	40	1.0	20	1.0	37.5	0.5	1.0	0.05
K27	42	1.0	37	1.0	22	1.0	37.5	0.5	1.0	0.05
K32	42	1.0	44	1.0	24	1.0	37.5	0.5	1.0	0.05
K42	42	1.0	45	1.0	30	1.0	37.5	0.5	1.0	0.05

Rating and Part Number

Vac	Vdc	Cap Value μF	Dimensions				Peak Current A	Surge Current A	dv/dt V/us	Lead Wire mm	Part Number
			w mm	H mm	T mm	P mm					
305	630	0.1	18	11	5	15	40	120	400	0.6	FXQ30K104E142EL5
305	630	0.15	18	12	6	15	60	180	400	0.6	FXQ30K154E172EL5
305	630	0.22	18	13.5	7.5	15	88	264	400	0.8	FXQ30K224E292EL5
305	630	0.27	18	14.5	8.5	15	108	324	400	0.8	FXQ30K274E342EL5
305	630	0.33	18	14.5	8.5	15	132	396	400	0.8	FXQ30K334E342EL5
305	630	0.47	18	16	10	15	188	564	400	0.8	FXQ30K474E432EL5
305	630	0.56	18	19	11	15	224	672	400	0.8	FXQ30K564E472EL5
305	630	0.68	18	19	11	15	272	816	400	0.8	FXQ30K684E472EL5
305	630	0.33	26	16.5	7	22.5	66	198	200	0.8	FXQ30K334F172FL5
305	630	0.47	26	16.5	7	22.5	94	282	200	0.8	FXQ30K474F172FL5
305	630	0.56	26	19	10	22.5	112	336	200	0.8	FXQ30K564F242FL5
305	630	0.68	26	19	10	22.5	136	408	200	0.8	FXQ30K684F242FL5
305	630	1	26	20	11	22.5	200	600	200	0.8	FXQ30K105F262FL5
305	630	1.2	26	22	12	22.5	240	720	200	0.8	FXQ30K125F272FL5
305	630	1.5	26	23	13	22.5	300	900	200	0.8	FXQ30K155F292FL5
305	630	1.8	26	29.5	14.5	22.5	360	1080	200	0.8	FXQ30K185F342FL5
305	630	2	26	29.5	14.5	22.5	400	1200	200	0.8	FXQ30K205F342FL5
305	630	2.2	26	29.5	14.5	22.5	440	1320	200	0.8	FXQ30M225F342FL5
305	630	0.68	32	18	9	27.5	102	306	150	0.8	FXQ30K684G152GL5
305	630	0.82	32	18	9	27.5	123	369	150	0.8	FXQ30K824G152GL5
305	630	1	32	20	11	27.5	150	450	150	0.8	FXQ30K105G182GL5
305	630	1.2	32	20	11	27.5	180	540	150	0.8	FXQ30M125G182GL5
305	630	1.5	32	24.5	13	27.5	225	675	150	0.8	FXQ30K155G222GL5
305	630	1.8	32	24.5	13	27.5	270	810	150	0.8	FXQ30K185G222GL5
305	630	2.2	32	24	14	27.5	330	990	150	0.8	FXQ30K225G252GL5
305	630	2.7	32	28	18	27.5	405	1215	150	0.8	FXQ30K275G332GL5
305	630	3.3	32	28	18	27.5	495	1485	150	0.8	FXQ30M335G332GL5
305	630	3.3	32	33	18	27.5	495	1485	150	0.8	FXQ30K335G342GL5
305	630	3.9	32	33	18	27.5	585	1755	150	0.8	FXQ30K395G342GL5
305	630	4.7	32	33	18	27.5	705	2115	150	0.8	FXQ30M475G342GL5
305	630	4.7	32	37	22	27.5	705	2115	150	0.8	FXQ30K475G402GL5
305	630	5.6	32	37	22	27.5	840	2520	150	0.8	FXQ30M565G402GL5
305	630	4.7	42	32	19	37.5	470	1410	100	1	FXQ30K475K212KL5
305	630	6.8	42	37	22	37.5	680	2040	100	1	FXQ30K685K272KL5
305	630	6.8	42	40	20	37.5	680	2040	100	1	FXQ30K685K242KL5
305	630	10	42	44	24	37.5	1000	3000	100	1	FXQ30K106K322KL5
305	630	12	42	45	30	37.5	1200	3600	100	1	FXQ30K126K422KL5
305	630	15	42	45	30	37.5	1500	4500	100	1	FXQ30K156K422KL5

Rating and Part Number

Vac	Vdc	Cap Value μF	Dimensions				Peak Current A	Surge Current A	dv/dt V/us	Lead Wire mm	Part Number
			w mm	H mm	T mm	P mm					
350	700	0.1	18	13.5	6	15	50	150	500	0.6	FXQ35K104E182EL5
350	700	0.15	18	13.5	7.5	15	75	225	500	0.8	FXQ35K154E292EL5
350	700	0.22	18	14.5	8.5	15	110	330	500	0.8	FXQ35K224E342EL5
350	700	0.33	18	16	10	15	165	495	500	0.8	FXQ35K334E432EL5
350	700	0.47	18	19	11	15	235	705	500	0.8	FXQ35M474E472EL5
350	700	0.47	26	17	8.5	22.5	188	564	400	0.8	FXQ35K474F202FL5
350	700	0.56	26	19	10	22.5	224	672	400	0.8	FXQ35K564F242FL5
350	700	0.68	26	20	11	22.5	272	816	400	0.8	FXQ35K684F262FL5
350	700	0.82	26	22	12	22.5	328	984	400	0.8	FXQ35K824F272FL5
350	700	1	26	23	13	22.5	400	1200	400	0.8	FXQ35K105F292FL5
350	700	1.2	26	25	15	22.5	480	1440	400	0.8	FXQ35K125F362FL5
350	700	1.5	26	29.5	14.5	22.5	600	1800	400	0.8	FXQ35K155F342FL5
350	700	1.8	32	28	14	22.5	360	1080	200	0.8	FXQ35K185G262GL5
350	700	2.0	32	28	14	27.5	400	1200	200	0.8	FXQ35M205G262GL5
350	700	2.2	32	28	18	27.5	440	1320	200	0.8	FXQ35K225G332GL5
350	700	2.7	32	28	18	27.5	540	1620	200	0.8	FXQ35M275G332GL5
350	700	3.0	32	33	18	27.5	600	1800	200	0.8	FXQ35K305G342GL5
350	700	3.3	32	33	18	27.5	660	1980	200	0.8	FXQ35M335G342GL5
350	700	3.9	32	37	22	27.5	780	2340	200	0.8	FXQ35K395G402GL5
350	700	4.7	32	37	22	27.5	940	2820	200	0.8	FXQ35M475G402GL5
350	700	4.7	42	32	19	37.5	470	1410	100	1.0	FXQ35K475K212KL5
350	700	5.6	42	37	22	37.5	560	1680	100	1.0	FXQ35K565K272KL5

General Technical Data

Application	Interference suppression \ Across-the-line (Class X2)
Dielectric	Metallized Polypropylene Film
Reference Standard	IEC 60384-14 / EN 60384-14 / UL 60384-14 / AEC-Q200D
Climatic Category	40/110/56 IEC60068-1
Passive Flammability Class	B
Operating Temperature Range	-40°C ~ +110°C (85°C ~110°C, decreasing factor 1.35% per °C for Urms)
Protection	Solvent resistant plastic case UL94 V-0 Thermosetting resin sealing UL 94 V-0 compliant
Installation	Any position
Packaging	Packed in cardboard boxes with protection for the terminals
Storage Conditions	Storage time: ≤24months from the date marked on the label package Average relative humidity per year ≤70% RH≤85% for 30 days randomly distributed throughout the year Dew is absent Temperature: -40°C ~ +85°C
Storage Life	Product that passed less than 2 years from production, No need reconfirmation
RoHS Compliant	Compliant with the restricted substance requirements of Directive 2011/65/EU
Flame Retardant Grade	Flame retardant performance accords with horizontal combustion grade HB and vertical combustion grade V-0.

Construction

Metallized Film	OPP & Al/Zn
Metal Sprayed	Sn/Zn Alloy
Connection Electrode	Copper clad steel wire or Tinned copper wires
Case	Plastic Case (UL94V-0)
Filling	Epoxy Resin (UL94V-0)
Film Construction	Mono Structure 

Electrical Characteristics

Voltage Range	305Vac / 350Vac
Capacitance Range	0.1μF to 15μF
Capacitance Tolerance	±10% or ±20% at +25°C
Capacitance	Measuring Frequency at 1kHz Measuring Voltage: 1±0.2V
Standard Atmospheric Conditions for Static Test	<p>Ambient temperature 15°C to 35°C (If there is any doubt on the results, the measurements shall be made at +20 +/- 5°C)</p> <p>Relative humidity 45% to 75% (If there is any doubt on the results, the measurements shall be made at 60% to 70%.)</p> <p>Air pressure 86 kPa to 106 kPa.</p>
Voltage Between Terminals U_{TT}	DC Voltage: 4.3xVR for 60 seconds or $\sqrt{2}(2U_R + 1000Vac)$ VDC for 2 seconds, charge current must be 1A max. Withstanding (DC) voltage (cut off current 10mA), rise time 100V/S.
Voltage Between Terminals and Case U_{TC}	$2U_R + 1500Vac$, 60s (at +20+/-2°C)
Dielectric Dissipation Factor $Tg\delta 0$	$\leq 2 \times 10^{-4}$
Dissipation Factor	0.0010 (20°C, 1KHz)
Insulation Resistance	R between leads, for $C \leq 0.33 \mu F$ at 100 V; 1 min > 15 000 MΩ RC between leads, for $C > 0.33 \mu F$ at 100 V; 1 min > 5000 MΩ*μF
Hot-Spot	$\leq 85^\circ C$
Life Expectancy	100 000hours (UR, $\Theta_{hotspot}=85^\circ C$)
Failure Rate	100 Fit
Max. Altitude	2000 m

Characteristics Curve

Maximum Current (I_{rms}) Vs Frequency

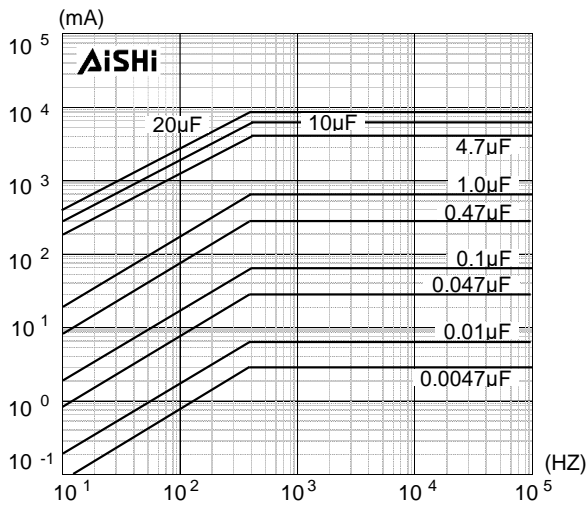

Resonant VS Capacitance

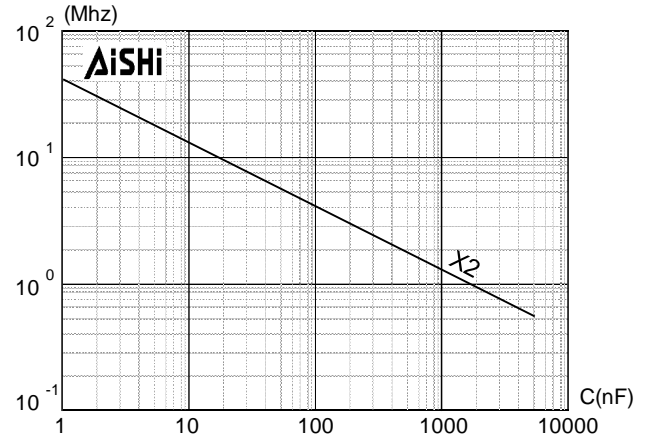

Maximum Voltage (V_{rms}) Versus Frequency

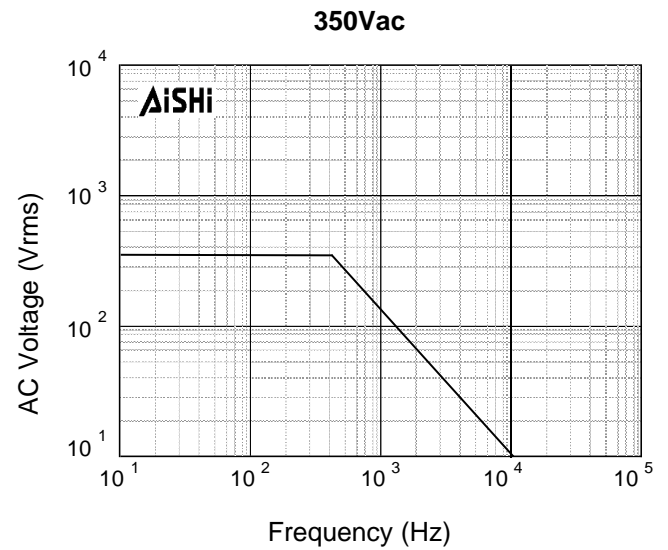
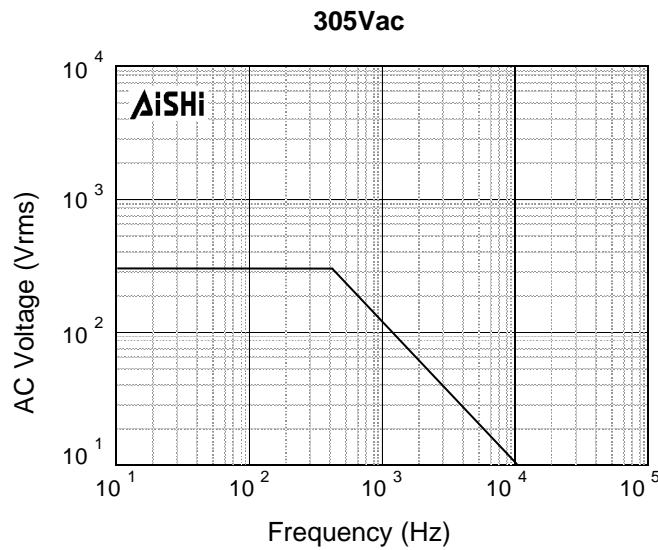

Biased Humidity Test

High Temperature High Humidity loading	<p>Test Condition 1: Reference: MIL-STD-202 Method 103 Test Temperature: +60+/-2°C Test Humidity: 95% R.H. Loading Voltage: Rated Voltage Test Duration: 1000 +24/-0 hours measurement at 24±4hours after test conclusion</p> <p>Performance: Capacitance Change Rate ($\Delta C/C$): $\leq \pm 5\%$ DF change ($\Delta \tan \delta$): $\leq 240 \cdot 10^{-4}$ at 10 KHz ($C \leq 1 \mu F$) DF change ($\Delta \tan \delta$): $\leq 150 \cdot 10^{-4}$ at 1 KHz. ($C > 1 \mu F$) Insulation Resistance: $\geq 50\%$ of initial limit</p> <p>Test Condition 2: Test Temperature: +85 +/-2°C Test Humidity: 85% R.H. Loading Voltage: Rated Voltage Test Duration: 2000 +24/-0 hours measurement at 24±4hours after test conclusion</p> <p>Performance: Capacitance Change Rate ($\Delta C/C$): $\leq \pm 10\%$ Maximum permissible increase of $\tan \delta$ between initial and final measurement: 0.024 for $C_N \leq 1 \mu F$ 0.015 for $C_N > 1 \mu F$ Insulation Resistance: $\geq 50\%$ of initial limit</p>
---	---

Expected Life Curve

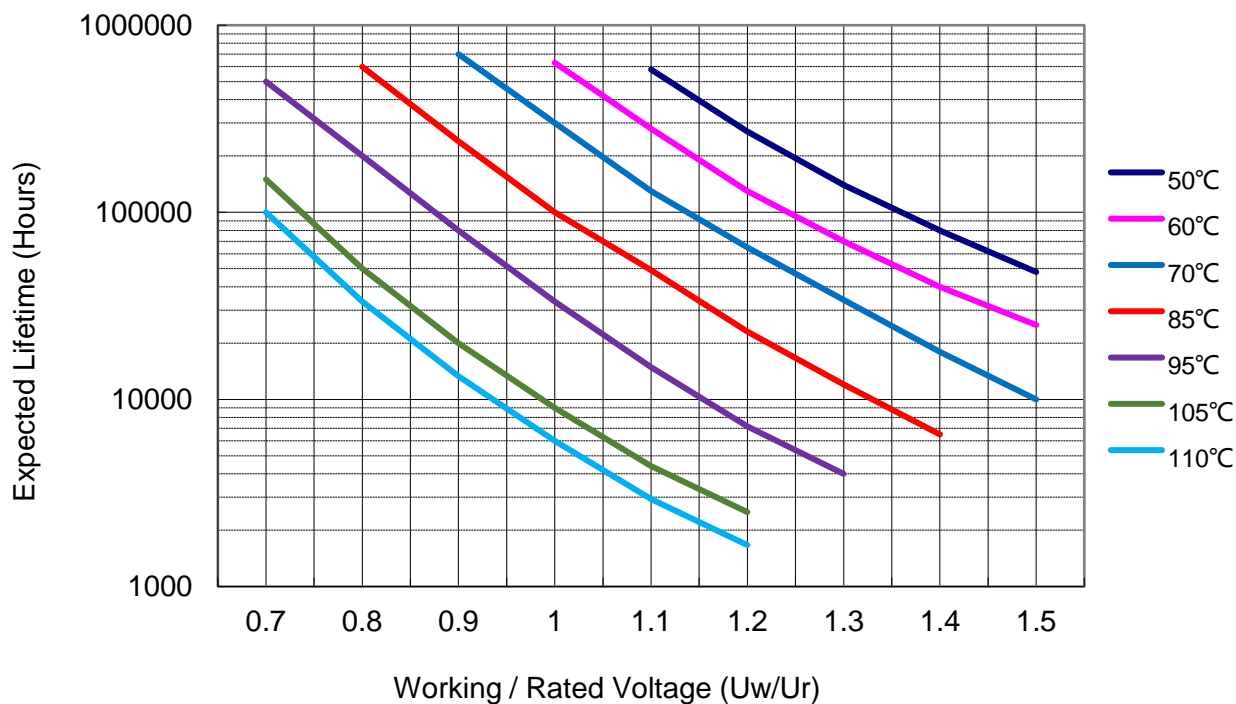

Derating of Rated Voltage Vs Temperature

(85°C ~110°C, decreasing factor 1.35% per °C for Urms)

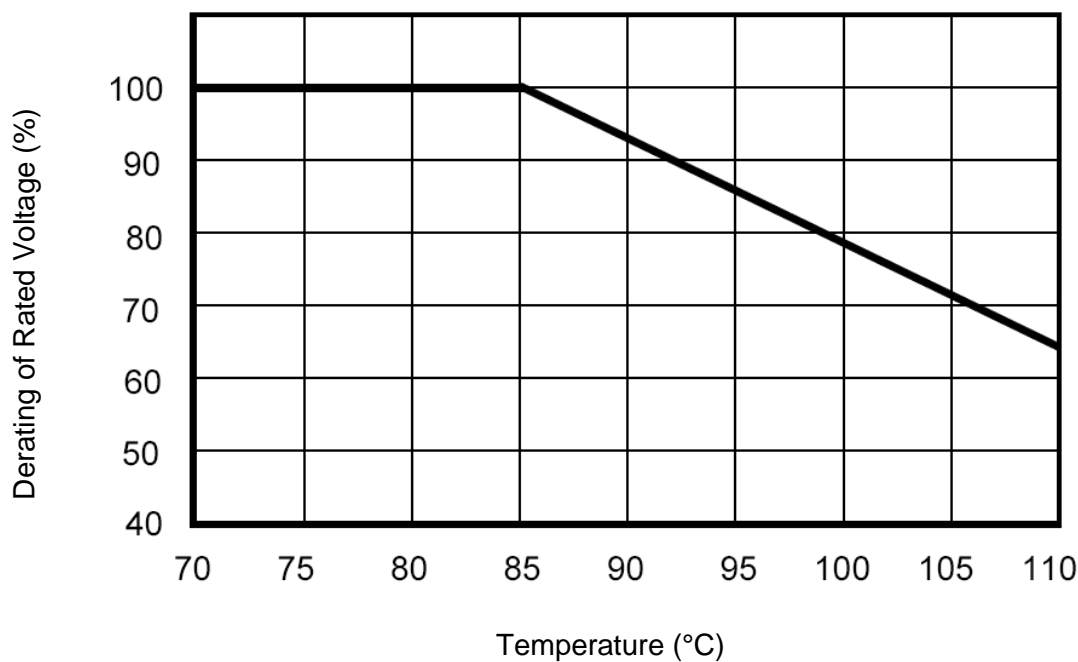

Wave Soldering Recommendations

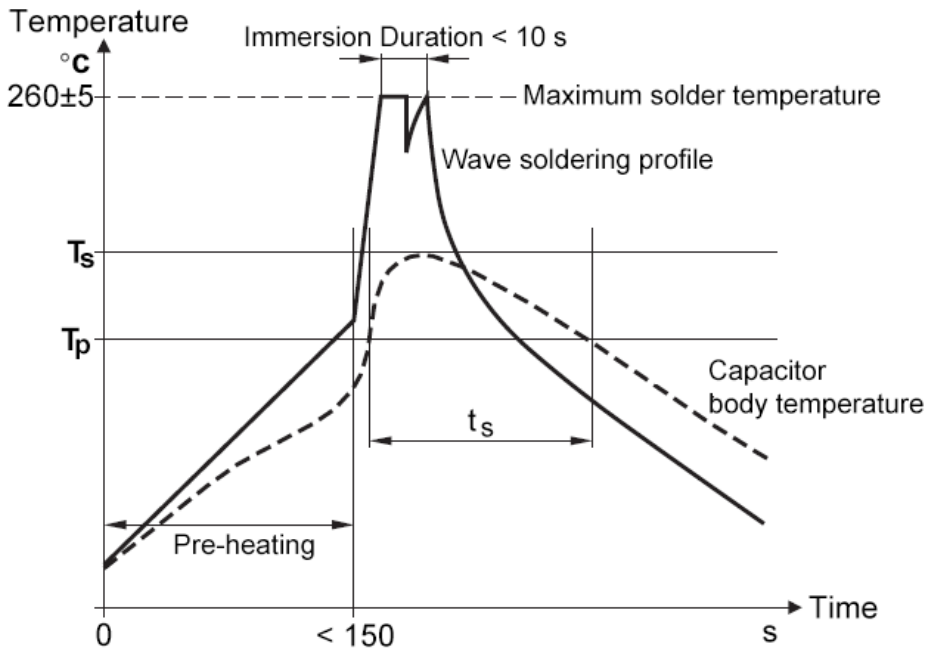

Ts: Capacitor body maximum temperature at wave soldering
 Tp: Capacitor body maximum temperature at pre-heating

Polypropylene Capacitors	Polyester Capacitors
During pre-heating: $T_p \leq 110^\circ\text{C}$ During soldering: $T_s \leq 120^\circ\text{C}$, $t_s \leq 60$	During pre-heating: $T_p \leq 130^\circ\text{C}$ During soldering: $T_s \leq 160^\circ\text{C}$, $t_s \leq 60\text{s}$

Packaging Information

Inner Box Specifications (Dimensions)			
Box #	L ±3mm	W±3mm	H ±3mm
# 1	331	331	25
# 2	331	331	35
# 3	331	331	50
# 4	331	331	80
# 5	350	170	35
# 6	350	170	50
# 7	350	170	80

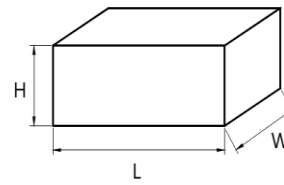

Outer Box Specifications (Dimensions)			
Box #	L ±5mm	W±5mm	H ±5mm
# 1	350	340	265
# 2	370	360	350

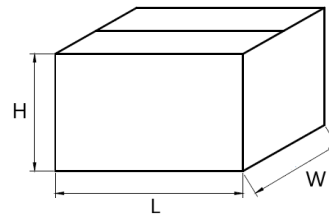

Packaging Quantity

Pitch	Size Code	Dimension			Packaging Quantity		
		W	H	T	Long Leads	Short Leads	Ammo Pack
15	E14	18	11	5	800	1,054	680
	E17	18	12	6	800	867	560
	E18	18	13.5	6	800	867	560
	E29	18	13.5	7.5	800	697	450
	E34	18	14.5	8.5	600	612	390
	E43	18	16	10	600	527	340
	E47	18	19	11	600	476	300
22.5	F17	26	16.5	7	528	528	300
	F20	26	17	8.5	432	432	250
	F24	26	19	10	372	372	210
	F26	26	20	11	336	336	190
	F27	26	22	12	300	300	170
	F29	26	23	13	276	276	160
	F34	26	29.5	14.5	252	252	140
F36	26	25	15	240	240	140	
27.5	G15	32	18	9	340	340	
	G18	32	20	11	280	280	
	G22	32	24.5	13	230	230	
	G25	32	24	14	220	220	
	G26	32	28	14	220	220	
	G33	32	28	18	170	170	
	G34	32	33	18	170	170	
G40	32	37	22	140	140		
37.5	K21	42	32	19	112	112	
	K24	42	40	20	105	105	
	K27	42	37	22	98	98	
	K32	42	44	24	91	91	
	K42	42	45	30	70	70	

Lead Taping Information

Taping Style: Straight leads

Lead spacing: 10 - 15mm

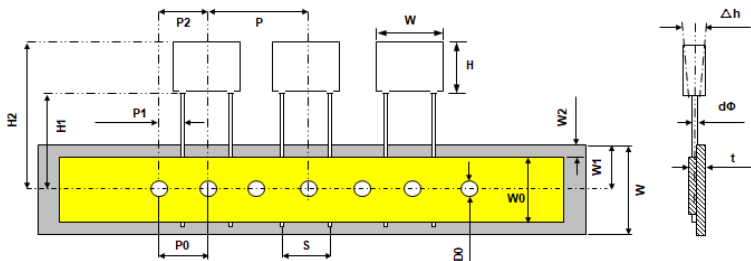

Quantity: 10pcs / line

Lead spacing: 22.5mm

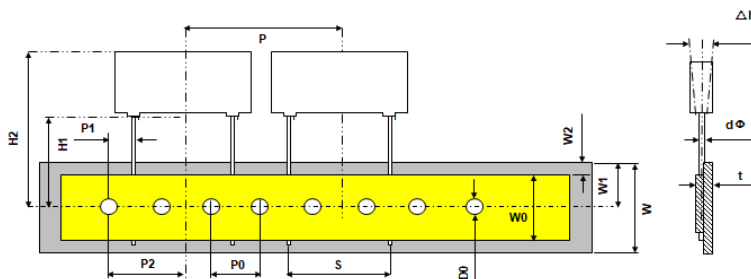

Quantity: 6pcs / line

Taping Specification

Description	Symbol	Dimension (mm)				Tolerance
Lead Spacing	S	10.0	12.5	15.0	22.5	+0.8/-0.2
Taping Pitch	P	25.4	25.4	25.4	38.0	±1.0
Feed Hole Pitch	P0	12.7	12.7	12.7	12.7	±0.2
Centering of Lead Wire	P1	7.7	6.5	5.2	7.80	±0.7
Centering of Body	P2	12.7	12.7	12.7	19.1	±1.3
Carrier Tape Width	W	18.0	18.0	18.0	18.0	±0.5
Hold Down Tape Width	W0	9.5	9.5	9.5	9.5	minimum
Hole Position	W1	9.0	9.0	9.0	9.0	±0.5
Hold Down Tape Position	W2	3.0	3.0	3.0	3.0	maximum
Feed Hole Diameter	D0	4.0	4.0	4.0	4.0	±0.2
Height of Component From Tape Center	H1	20.0	20.0	20.0	20.0	±0.5
Top Edge of Component	H2	39.0	39.0	39.0	44.0	maximum
Lead Wire Diameter	d	0.6	0.8	0.8	0.8	±0.1
Component Alignment	△h	0.0	0.0	0.0	0.0	±2.0
Tape Thickness	t	0.7	0.7	0.7	0.7	±0.2

Cautions and Warnings

- Don't exceed the upper category temperature.
- For longtime storage, maximum relative humidity 80%, no dew allowed on the capacitor.
- Do not use or store capacitor in corrosive atmosphere, in the dusty environment's regular maintenance and cleaning especially of the terminals is required to avoid conductive path between terminal / or terminal and ground.
- Don't apply any mechanical stress to the capacitor terminals, and avoid any compressive, tensile or flexural stress.
- Don't move the capacitor after fixed to the PC board, and don't pick up the PC board by the fixed capacitor.
- Don't place the capacitor on a PC board whose holes pitch differs from the specified space.
- Avoid overload of the capacitors
- Do not have unlimited service life expectancy, the max service life expectancy may vary depending on the application the capacitor is used in.

Disclaimer

All product, product specifications and data in this datasheet are subject to change without notice to improve reliability, function or design or otherwise. The customer is responsible for checking and verifying the extent to which the information contained in this publication is applicable to an order at the time the order is placed. All information given herein is believed to be accurate and reliable, but it is presented without guarantee, warranty, or responsibility of any kind, expressed or implied. The customer shall always refer to final datasheet as agreed between AiSHi and the customer.

In individual cases, a malfunction of electronic components or failure before the end of their usual service life cannot be completely ruled out in the current state of the art, even if they are operated as specified. In customer application requiring a very high level of operational safety and especially in customer applications in which the malfunction or failure of an electronic component could endanger human life or health (e.g. in accident prevention or lifesaving systems), it must therefore be ensured by means of suitable design of the customer application or other action taken by the customer (e.g. installation of protective circuitry or redundancy) that no injury or damage is sustained by third parties in the event of malfunction or failure of an electronic component.

We continue efforts to improve our products. Therefore, the products described in this publication may change from time to time. The same is true of the corresponding product specifications. Please check therefore to what extent product descriptions and specifications contained in this publication are still applicable before or when you place an order. We also reserve the right to discontinue production and delivery of products. Consequently, we cannot guarantee that all products named in this publication will always be available.

No license, express or implied, by estoppel or otherwise, to any intellectual property rights is granted by this document or by any conduct of AiSHi. Product names and markings noted herein may be trademarks of their respective owners.