

DFS Test Report

Report No.: RE171207E10I-2

Test Model: BLACK bean

Received Date: Oct. 16, 2014

Test Date: Dec. 15, 2014

Issued Date: Apr. 15, 2019

Applicant: UAB 8devices

Address: Antakalnio 17, LT-10312, Vilnius, Lithuania

Issued By: Bureau Veritas Consumer Products Services (H.K.) Ltd., Taoyuan Branch
Hsin Chu Laboratory

Lab Address: E-2, No.1, Li Hsin 1st Road, Hsinchu Science Park, Hsinchu City 300,
Taiwan R.O.C.

Test Location: E-2, No.1, Li Hsin 1st Road, Hsinchu Science Park, Hsinchu City 300,
Taiwan R.O.C.



This report is for your exclusive use. Any copying or replication of this report to or for any other person or entity, or use of our name or trademark, is permitted only with our prior written permission. This report sets forth our findings solely with respect to the test samples identified herein. The results set forth in this report are not indicative or representative of the quality or characteristics of the lot from which a test sample was taken or any similar or identical product unless specifically and expressly noted. Our report includes all of the tests requested by you and the results thereof based upon the information that you provided to us. You have 60 days from date of issuance of this report to notify us of any material error or omission caused by our negligence, provided, however, that such notice shall be in writing and shall specifically address the issue you wish to raise. A failure to raise such issue within the prescribed time shall constitute your unqualified acceptance of the completeness of this report, the tests conducted and the correctness of the report contents. Unless specifically mentioned, the uncertainty of measurement has been explicitly taken into account to declare the compliance or non-compliance to the specification.

Table of Contents

Release Control Record	3
1 Certificate of Conformity	4
2 Dynamic Frequency Selection	5
2.1 Test Limits and Radar Signal Parameters	6
2.2 EUT Information	9
2.3 Test Instruments	10
2.4 Description of Support Units	10
2.5 Test Procedure	11
2.6 Deviation from Test Standard	11
2.7 Test Setup Configuration	11
2.8 List of Measurements	12
2.9 Test Result	13
2.9.1 Interference Threshold Values Injected into AP	13
2.9.2 Channel Shutdown	14
3 Photographs of the Test Configuration	16
Appendix - Information of the Testing Laboratories	17

Release Control Record

Issue No.	Description	Date Issued
RE171207E10I-2	Original release.	Apr. 15, 2019

1 Certificate of Conformity

Product: BLACK-Bean
Brand: 8devices
Test Model: BLACK bean
Sample Status: R&D SAMPLE
Applicant: UAB 8devices
Test Date: Dec. 15, 2014
Standards: EN 301 893 V2.1.1 (2017-05)
Test Item: Dynamic Frequency Selection
(Clause 4.2.6)

The above equipment has been tested by **Bureau Veritas Consumer Products Services (H.K.) Ltd., Taoyuan Branch**, and found compliance with the requirement of the above standards. The test record, data evaluation & Equipment Under Test (EUT) configurations represented herein are true and accurate accounts of the measurements of the sample's EMC characteristics under the conditions specified in this report.

Prepared by : Phoenix Huang, **Date:** Apr. 15, 2019
Phoenix Huang / Specialist

Approved by : May Chen, **Date:** Apr. 15, 2019
May Chen / Manager

2 Dynamic Frequency Selection

The manufacturer shall state whether the UUT is capable of operating as a Master and/or a Slave. If the UUT is capable of operating in more than one operating mode then each operating mode shall be tested separately. See below table for the applicability of DFS requirements for each of the operational modes.

Applicability of DFS requirements

Requirement	Operational Mode		
	Master	Slave (without radar detection)	Slave (with radar detection)
Channel Availability Check	✓	Not required	✓ (see note 2)
Off-Channel CAC (see note 1)	✓	Not required	✓ (see note 2)
In-Service Monitoring	✓	Not required	✓
Channel Shutdown	✓	✓	✓
Non-Occupancy Period	✓	Not required	✓
Uniform Spreading	✓	Not required	Not required

NOTE 1: Where implemented by the manufacturer.

NOTE 2: A slave with radar detection is not required to perform a CAC or Off-Channel CAC at initial use of the channel but only after the slave has detected a radar signal on the Operating Channel by In-Service Monitoring and the Non-Occupancy Period resulting from this detection has elapsed.

The radar detection requirements specified in EN 301 893 clauses 4.2.6.2.2 to 4.2.6.2.4 assume that the centre frequencies of the radar signals fall within the central 80 % of the Occupied Channel Bandwidth of the RLAN channel.

2.1 Test Limits and Radar Signal Parameters

DFS requirement values

Parameter	Value
Channel Availability Check Time	60 s (see note 1)
Minimum Off-Channel CAC Time	6 minutes (see note 2)
Maximum Off-Channel CAC Time	4 hours (see note 2)
Channel Move Time	10 s
Channel Closing Transmission Time	1 s
Non-Occupancy Period	30 minutes

NOTE 1: For channels whose nominal bandwidth falls completely or partly within the band 5 600 MHz to 5 650 MHz, the Channel Availability Check Time shall be 10 minutes.

NOTE 2: For channels whose nominal bandwidth falls completely or partly within the band 5 600 MHz to 5 650 MHz, the Maximum Off-Channel CAC Time shall be within the range 1 to 24 hours.

Interference threshold values

EIRP Spectral Density dBm/MHz	Value (see notes 1 and 2)
10	-62 dBm

NOTE 1: This is the level at the input of the receiver of a RLAN device with a maximum EIRP density of 10 dBm/MHz and assuming a 0 dBi receive antenna. For devices employing different EIRP spectral density and/or a different receive antenna gain G (dBi) the DFS threshold level at the receiver input follows the following relationship:

DFS Detection Threshold (dBm) = -62 + 10 · EIRP Spectral Density (dBm/MHz) + G (dBi),
however the DFS threshold level shall not be lower than -64 dBm assuming a 0 dBi receive antenna gain.

NOTE 2: Slave devices with a maximum e.i.r.p. of less than 23 dBm do not have to implement radar detection unless these devices are used in fixed outdoor point to point or fixed outdoor point to multipoint applications.

Parameters of the reference DFS test signal

Pulse width W [µs]	Pulse repetition frequency PRF [pps]	Pulses per burst [PPB]
1	700	18

Parameters of radar test signals

Radar Test Signal # (see notes 1 to 3)	Pulse width W [μ s]		Pulse Repetition Frequency (pps)		Number of different PRFs	Pulses per Burst for each PRF (PPB) (see notes 5)
	Min	Max	Min	Max		
1	0.5	5	200	1000	1	10 (see note 6)
2	0.5	15	200	1600	1	15 (see note 6)
3	0.5	15	2300	4000	1	25
4	20	30	2000	4000	1	20
5	0.5	2	300	400	2/3	10 (see note 6)
6	0.5	2	400	1200	2/3	15 (see note 6)

NOTE 1: Radar test signals 1 to 4 are constant PRF based signals. See figure D.1. These radar test signals are intended to simulate also radars using a packet based Staggered PRF. See figure D.2.

NOTE 2: Radar test signal 4 is a modulated radar test signal. The modulation to be used is a chirp modulation with a $\pm 2,5$ MHz frequency deviation which is described below.

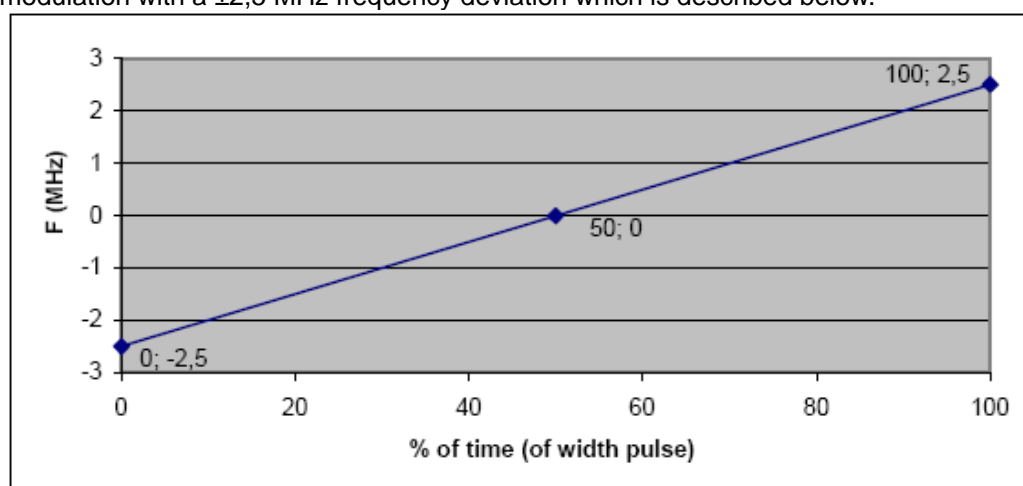

NOTE 3: Radar test signals 5 and 6 are single pulse based Staggered PRF radar test signals using 2 or 3 different PRF values. For radar test signal 5, the difference between the PRF values chosen shall be between 20 pps and 50 pps. For radar test signal 6, the difference between the PRF values chosen shall be between 80 pps and 400 pps. See figure D.3

NOTE 4: Apart for the Off-Channel CAC testing, the radar test signals above shall only contain a single burst of pulses. See figures D.1, D.3 and D.4. For the Off-Channel CAC testing, repetitive bursts shall be used for the total duration of the test. See figures D.2 and D.5. See also clause 4.2.6.2.3, 5.4.8.2.1.4.2 and 5.4.8.2.1.4.3.

NOTE 5: The total number of pulses in a burst is equal to the number of pulses for a single PRF multiplied by the number of different PRFs used.

NOTE 6: For the CAC and Off-Channel CAC requirements, the minimum number of pulses (for each PRF) for any of the radar test signals to be detected in the band 5 600 MHz to 5 650 MHz shall be 18.

Detection probability

Parameter	Detection Probability (Pd)	
	Channels whose nominal bandwidth falls partly or completely within the 5600 MHz to 5650 MHz band	Other channels
CAC, Off-Channel CAC	99,99 %	60 %
In-Service Monitoring	60 %	60 %

NOTE: Pd gives the probability of detection per simulated radar burst and represents a minimum level of detection performance under defined conditions. Therefore Pd does not represent the overall detection probability for any particular radar under real life conditions.

2.2 EUT Information

Operating Frequency Bands and Mode of EUT

Operational Mode	Operating Frequency Range	
	5250~5350MHz	5470~5725MHz
Slave without Radar Detection	✓	✓

EUT Software and Firmware Version

No.	Product	Model No.	Software/Firmware Version
1	BLACK-Bean	BLACK bean	BIT90 11.0.0.432

Description of Available Antennas to the EUT

Ant. No.	Transmitter Circuit	Brand	Model	Ant. Type	2.4GHz Gain with cable loss (dBi)	5GHz Gain with cable loss (dBi)	2.4GHz Cable Loss (dBi)	5G Cable Loss (dBi)	Connector Type	Cable Length (mm)
1	Main	WNC	81-EBJ15.005	PIFA	3.00	Band 1&2: 2.56	1.15	Band 1&2: 1.70	IPEX	300
						Band 3: 4.76		Band 3: 1.74		
						Band 4: 4.76		Band 4: 1.79		
	Aux	WNC	81-EBJ15.005	PIFA	3.62	Band 1&2: 3.08	1.15	Band 1&2: 1.70	IPEX	300
						Band 3: 3.31		Band 3: 1.74		
						Band 4: 2.42		Band 4: 1.79		
2	Main	WNC	81.ED415.001	PIFA	0.22	Band 1&2: 5.56	0.96	Band 1&2: 1.29	IPEX	300
						Band 3: 5.03		Band 3: 1.36		
						Band 4: 3.14		Band 4: 1.38		
	Aux	WNC	81.ED415.001	PIFA	1.48	Band 1&2: 5.17	0.96	Band 1&2: 1.29	IPEX	300
						Band 3: 5.34		Band 3: 1.36		
						Band 4: 2.93		Band 4: 1.38		

Note: 1. Above antenna gains of antenna are Total (H+V).

2.3 Test Instruments

Description & Manufacturer	Model No.	Brand	Calibrated Date	Calibrated Until
Spectrum Analyzer R&S	FSW8	101497	Aug. 06, 2014	Aug. 05, 2015
Signal generator	SMJ100A	R&S	Aug. 12, 2014	Aug. 11, 2015

2.4 Description of Support Units

No.	Product	Brand	Model No.	Spec.
1	WIRELESS AC MODULE	ALPHA	WMC-AC01	Maximum EIRP Spectral Density is 16.9dBm/MHz and antenna gain is 3.82dBi.

NOTE: This device was functioned as a Master Slave device during the DFS test.

Software/Firmware information

No.	Product	Model No.	Software/Firmware Version
1	WIRELESS AC MODULE	WMC-AC01	1.0.0 Mon 04 Feb 2013 (version 6.30.163.13.r373323 WLTEST)

Note: This module WMC-AC01 was installed in the DIR-868L AP.

2.5 Test Procedure

The measured channel is 5300MHz and 5500MHz in 20MHz Bandwidth and 5290MHz and 5530MHz in 80MHz Bandwidth. The radar signal was the same as transmitted channels, and injected into the antenna port of AP (master) with -60.18dBm power level, measured the channel shutdown. The slave transmitted the test data to master, the transmitted duty cycle is 30.95%.

Channel Closing Transmission Time & Channel Move Time @ CH60

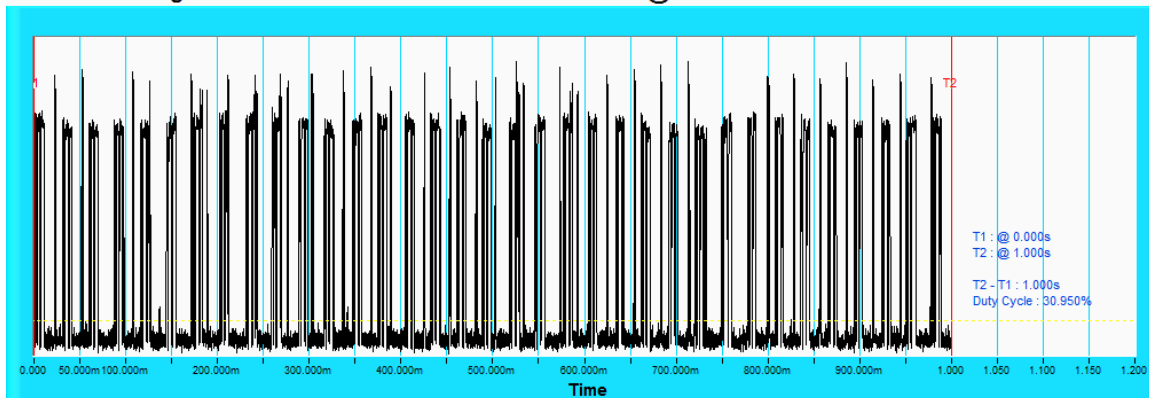

NOTE: T1 denotes the start of duty cycle period is 0th second. T2 denotes the end of duty cycle period is 1th second. $T2 - T1 = 1$ seconds. Duty Cycle = 30.95%

Note: Traffic signal: from slave transmit to master.

2.6 Deviation from Test Standard

No deviation.

2.7 Test Setup Configuration

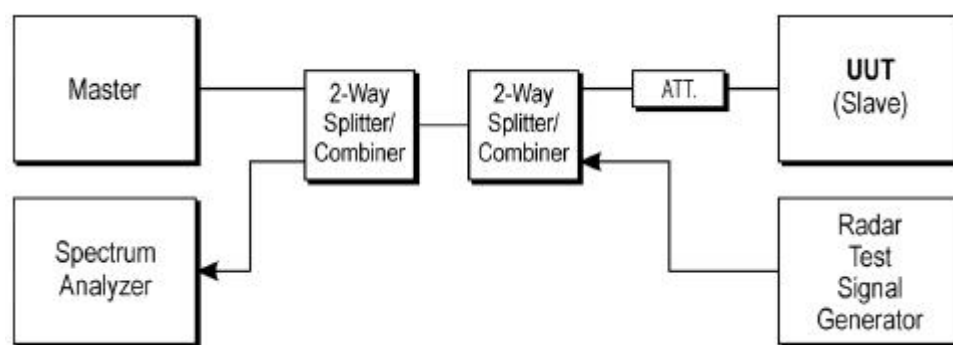

The UUT is a RLAN device operating in slave mode, without Radar Interference Detection function. The radar test signals are injected into the master device.

2.8 List of Measurements

Clause	Test Parameter	Remarks	Pass/Fail
4.2.6.2.2	Channel Availability Check Time	Not Applicable	NA
4.2.6.2.3	Off-Channel CAC	Not implemented	NA
4.2.6.2.4	In-Service Monitoring	Not Applicable	NA
4.2.6.2.5	Channel Shutdown	Applicable	Pass
4.2.6.2.6	Non- Occupancy Period	Not Applicable	NA
4.2.6.2.7	Uniform Spreading	Not Applicable	NA

2.9 Test Result

2.9.1 Interference Threshold Values Injected into AP

The AP Maximum EIRP Spectral Density is 16.9dBm/MHz and antenna gain is 4dBi, cable loss is 0.18. DFS Detection Threshold = $-62 + 10 - \text{EIRP Spectral Density (16.9dBm/MHz)} + G (0\text{dBi}) = -68.9\text{dBm}$. For an interference threshold level of -64dBm and the AP net gain is 3.82dBi. Then the radar Burst signal level to the AP connector is -60.18dBm .

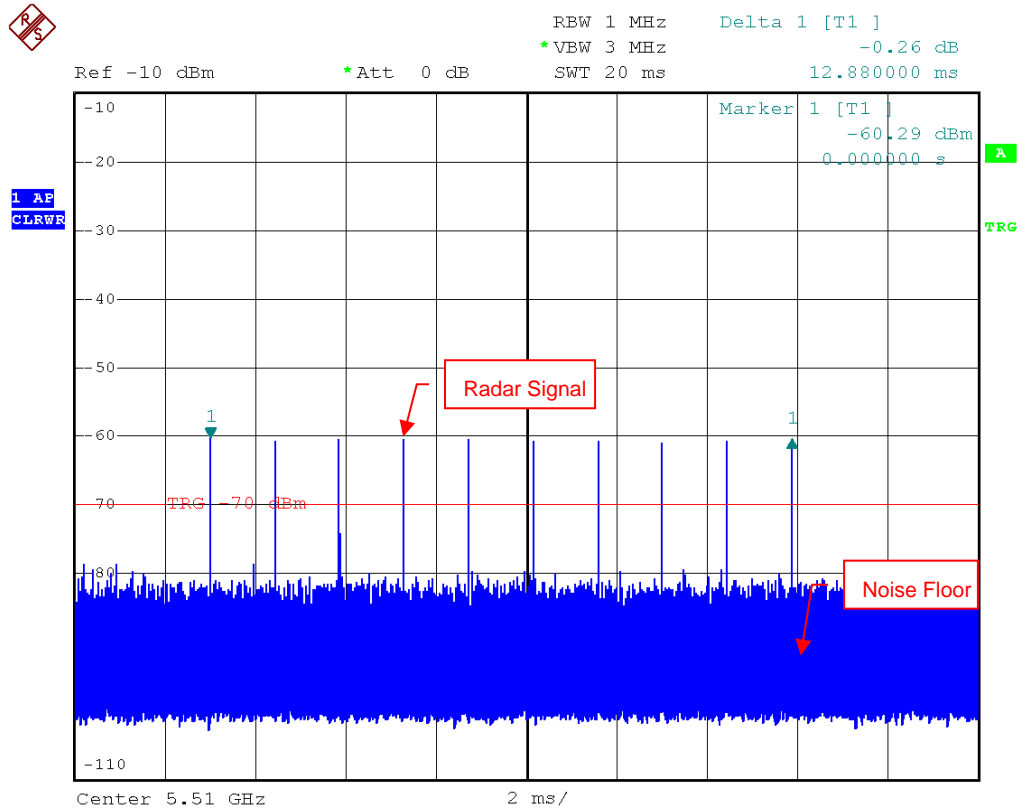

Reference DFS test signal

2.9.2 Channel Shutdown

802.11n (HT20) mode

Channel Closing Transmission Time & Channel Move Time @ CH60

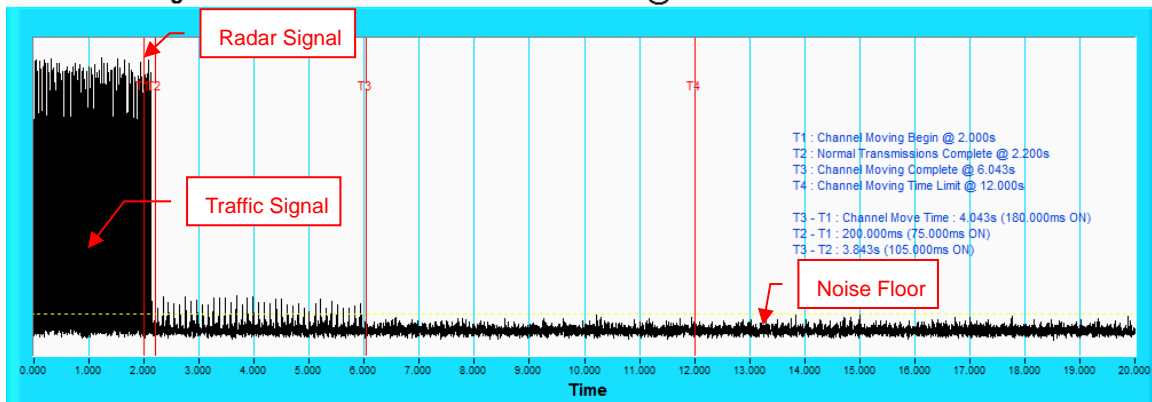

NOTE: T1 denotes the start of Channel Move Time upon the end of the last Radar burst. T2 denotes the data transmission time of 200ms from T1. T3 denotes the end of Channel Move Time. T4 denotes the 10 second from T1 to observe the aggregate duration of transmissions.

Channel Closing Transmission Time & Channel Move Time @ CH100

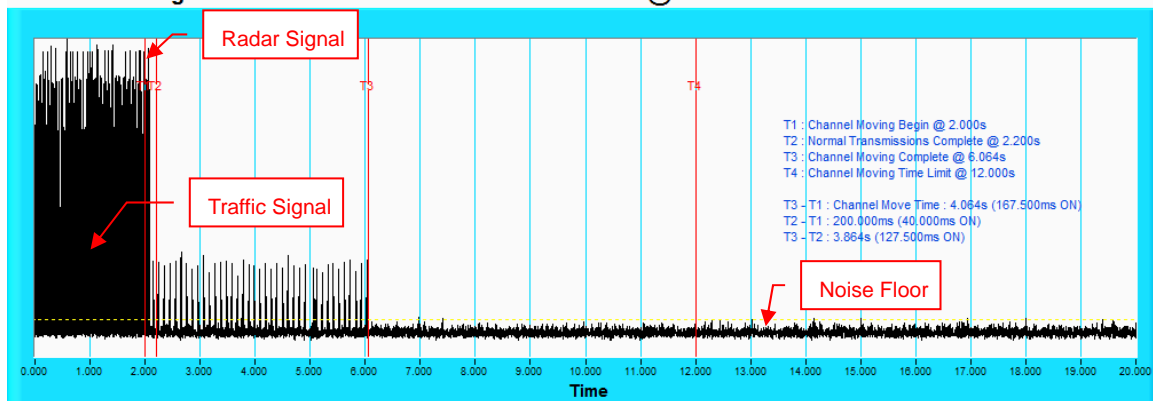

NOTE: T1 denotes the start of Channel Move Time upon the end of the last Radar burst. T2 denotes the data transmission time of 200ms from T1. T3 denotes the end of Channel Move Time. T4 denotes the 10 second from T1 to observe the aggregate duration of transmissions.

802.11ac (VHT80) mode

Channel Closing Transmission Time & Channel Move Time @ CH58

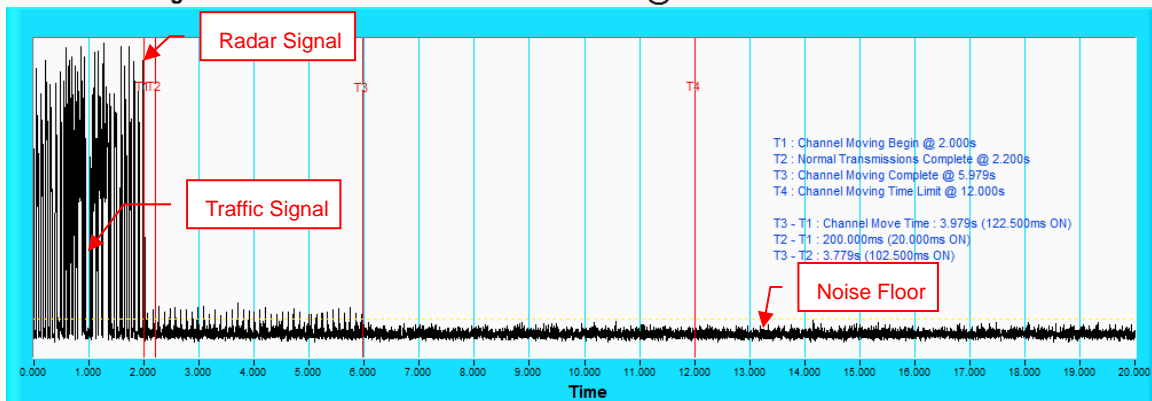

NOTE: T1 denotes the start of Channel Move Time upon the end of the last Radar burst. T2 denotes the data transmission time of 200ms from T1. T3 denotes the end of Channel Move Time. T4 denotes the 10 second from T1 to observe the aggregate duration of transmissions.

Channel Closing Transmission Time & Channel Move Time @ CH106

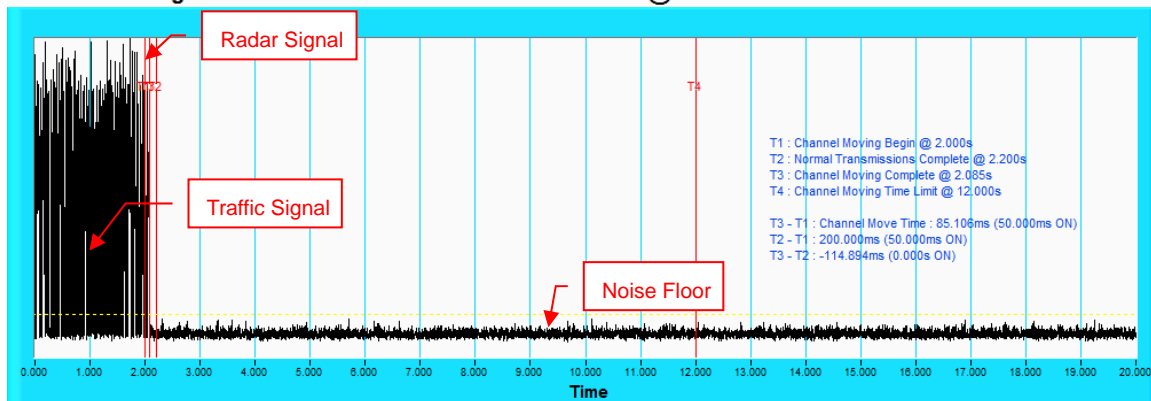

NOTE: T1 denotes the start of Channel Move Time upon the end of the last Radar burst. T2 denotes the data transmission time of 200ms from T1. T3 denotes the end of Channel Move Time. T4 denotes the 10 second from T1 to observe the aggregate duration of transmissions.

3 Photographs of the Test Configuration

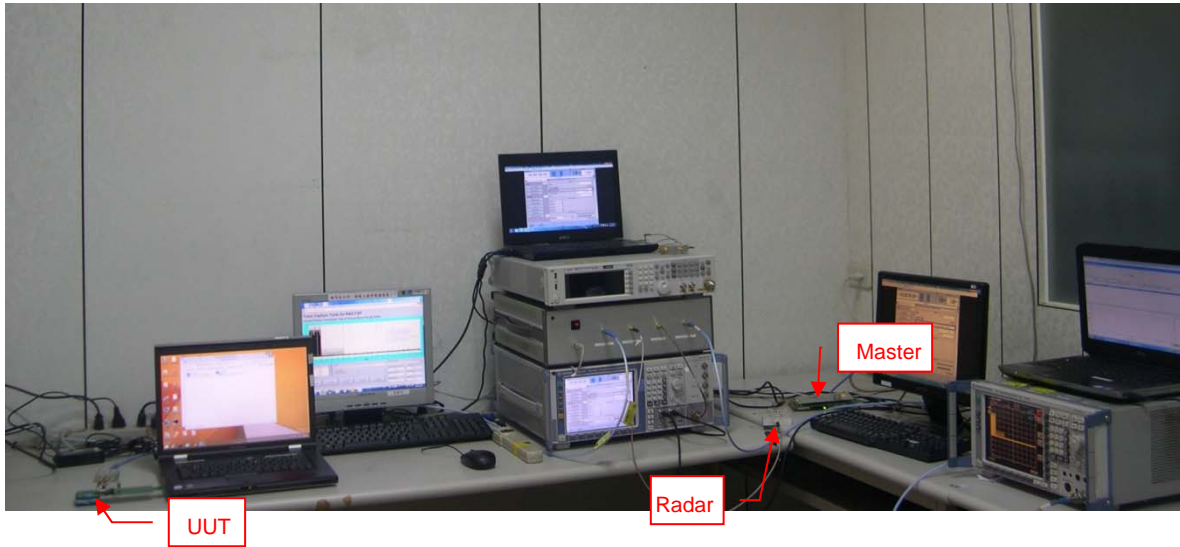

Appendix - Information of the Testing Laboratories

We, Bureau Veritas Consumer Products Services (H.K.) Ltd., Taoyuan Branch, were founded in 1988 to provide our best service in EMC, Radio, Telecom and Safety consultation. Our laboratories are accredited and approved according to ISO/IEC 17025.

If you have any comments, please feel free to contact us at the following:

Linko EMC/RF Lab

Tel: 886-2-26052180

Fax: 886-2-26051924

Hsin Chu EMC/RF/Telecom Lab

Tel: 886-3-6668565

Fax: 886-3-6668323

Hwa Ya EMC/RF/Safety Lab

Tel: 886-3-3183232

Fax: 886-3-3270892

Email: service.adt@tw.bureauveritas.com

Web Site: www.bureauveritas-adt.com

The address and road map of all our labs can be found in our web site also.

--- END ---