



Fixed Resistors CONTENTS

Classification	Product Item	Part No.	Page	
Safety Precautions (Common precautions for Fixed Resistors)			2	
Surface Mount Resistors	Chip Resistors	Thick Film Chip Resistors	ERJ XG, 1G, 2G, 3G, 6G, 8G, 14, 12, 12Z, 1T	3
		Precision Thick Film Chip Resistors	ERJ XG, 1G, 1R, 2R, 3R, 6R, 3E, 6E, 8E, 14, 12, 1T	5
	High Precision	Metal Film (Thin Film) Chip Resistors, High Reliability Type	ERA 1A, 2A, 3A, 6A, 8A	8
	Current Sensing	Thick Film Chip Resistors / Low Resistance Type	ERJ 2LW, 3LW, 2B, 3B, 6B, 8B, 14B, 8C, 3R, 6R, 8R, 14R, 12R ERJ 12Z, 1TR, L03, L06, L08, L14, L12, L1D, L1W	10
		Current Sensing Resistors, Metal Plate Type	ERJ MS4S, MS4H, MS6S	14
		Current Sensing Resistors, Metal Plate Type	ERJ M1WS, M1WT	18
		High Power Chip Resistors / Wide Terminal Type	ERJ A1, B1, B2, B3	20
	Small&High Power	Anti-Surge Thick Film Chip Resistors	ERJ P03, PA3, P06, P08, P14	23
		Anti-Pulse Thick Film Chip Resistors	ERJ T06, T08, T14	25
	Anti-Sulfurated	Anti-Sulfurated Thick Film Chip Resistors	ERJ S02, S03, S06, S08, S14, S12, S1D, S1T, S6S, S6Q ERJ U01, U02, U03, U06, U08, U14, U12, U1D, U1T	27
		Anti-Sulfurated High Power Chip Resistors / Wide Terminal Type	ERJ C1	30
	Resistor Network/Array	Chip Resistor Array	EXB 14V, 18V, 24V, 28V, N8V, 2HV, 34V, V4V, 38V, V8V, S8V	32
		Metal Film Chip Resistor Array	ERA38V	35
		Anti-Sulfurated Chip Resistor Array	EXB U2, U3	37
		Chip Resistor Networks	EXB D, E, A, Q	39
		Chip Attenuator	EXB 14AT, 24AT	41
	Common specifications	Packaging Methods (Taping)		43
		Recommended Land Pattern		47
		Recommended Soldering Conditions		49
		Safety Precautions (Common precautions for Surface Mount Resistors)		50
Power Type Resistors (Leaded)	Metal (Oxide) Film Resistors, Flame-Retardant	ERG 12S, 1S, 1F, 2S, 2F, 3S, 3F, 5S, 5F ERX 12S, 1S, 1F, 2S, 2F, 3S, 3F, 5S, 5F	51	
	Anti-Pulse Power Resistors	ERG 12D, 1D, 2D, 3D	58	
	Metal Film Resistors / Low Resistance Value	ERX 12L, 1L, 2L	60	
Fusing Resistors	Metal Film Fusing Resistors	ERQ 1Z, 2Z, 12Z, 14Z ERQ 1AB, 2AB, 12A, 14A	62	
Fixed Resistors Appendix			68	

All products in this catalog comply with the RoHS Directive.

The RoHS Directive is “the Directive (2011/65/EU) on the Restriction of the Use of Certain Hazardous Substances in Electrical and Electronic Equipment “ and its revisions.

⚠ Safety Precautions (Common precautions for Fixed Resistors)

- When using our products, no matter what sort of equipment they might be used for, be sure to make a written agreement on the specifications with us in advance. The design and specifications in this catalog are subject to change without prior notice.
- Do not use the products beyond the specifications described in this catalog.
- This catalog explains the quality and performance of the products as individual components. Before use, check and evaluate their operations when installed in your products.
- Install the following systems for a failsafe design to ensure safety if these products are to be used in equipment where a defect in these products may cause the loss of human life or other significant damage, such as damage to vehicles (automobile, train, vessel), traffic lights, medical equipment, aerospace equipment, electric heating appliances, combustion/gas equipment, rotating equipment, and disaster/crime prevention equipment.
- * Systems equipped with a protection circuit and a protection device
- * Systems equipped with a redundant circuit or other system to prevent an unsafe status in the event of a single fault

(1) Precautions for use

- These products are designed and manufactured for general and standard use in general electronic equipment (e.g. AV equipment, home electric appliances, office equipment, information and communication equipment)
- These products are not intended for use in the following special conditions. Before using the products, carefully check the effects on their quality and performance, and determine whether or not they can be used.
 1. In liquid, such as water, oil, chemicals, or organic solvent
 2. In direct sunlight, outdoors, or in dust
 3. In salty air or air with a high concentration of corrosive gas, such as Cl₂, H₂S, NH₃, SO₂, or NO₂
 4. Electric Static Discharge (ESD) Environment
These components are sensitive to static electricity and can be damaged under static shock (ESD). Please take measures to avoid any of these environments.
Smaller components are more sensitive to ESD environment.
 5. Electromagnetic Environment
Avoid any environment where strong electromagnetic waves exist.
 6. In an environment where these products cause dew condensation
 7. Sealing or coating of these products or a printed circuit board on which these products are mounted, with resin or other materials
- These products generate Joule heat when energized. Carefully position these products so that their heat will not affect the other components.
- Carefully position these products so that their temperatures will not exceed the category temperature range due to the effects of neighboring heat-generating components. Do not mount or place heat-generating components or inflammables, such as vinyl-coated wires, near these products.
- Note that non-cleaning solder, halogen-based highly active flux, or water-soluble flux may deteriorate the performance or reliability of the products.
- Carefully select a flux cleaning agent for use after soldering. An unsuitable agent may deteriorate the performance or reliability. In particular, when using water or a water-soluble cleaning agent, be careful not to leave water residues. Otherwise, the insulation performance may be deteriorated.

(2) Precautions for storage

The performance of these products, including the solderability, is guaranteed for a year from the date of arrival at your company, provided that they remain packed as they were when delivered and stored at a temperature of 5 °C to 35 °C and a relative humidity of 45 % to 85 %.

Even within the above guarantee periods, do not store these products in the following conditions. Otherwise, their electrical performance and/or solderability may be deteriorated, and the packaging materials (e.g. taping materials) may be deformed or deteriorated, resulting in mounting failures.

1. In salty air or in air with a high concentration of corrosive gas, such as Cl₂, H₂S, NH₃, SO₂, or NO₂
2. In direct sunlight

This is all for the common precautions. Also refer to the "CAUTION AND WARNING" section located on the back of the front cover of this catalog and precautions for individual products shown in the subsequent pages.

<Package markings>

Package markings include the product number, quantity, and country of origin. In principle, the country of origin should be indicated in English.

Thick Film Chip Resistors

Type: **ERJ XG, 1G, 2G, 3G, 6G, 8G, 14, 12, 12Z, 1T**



Features

- Small size and lightweight
- High reliability
Metal glaze thick film resistive element and three layers of electrodes
- Compatible with placement machines
Taping packaging available
- Suitable for both reflow and flow soldering
- Reference Standards
IEC 60115-8, JIS C 5201-8, EIAJ RC-2134B
- AEC-Q200 qualified (Exemption ERJXG)
- RoHS compliant

As for Packaging Methods, Land Pattern, Soldering Conditions and Safety Precautions,
Please see Data Files

Explanation of Part Numbers

- ERJXGN, 1GN, 2GE, 3GE, 6GE, 8GE, 14, 12, 12Z, 1T Type, $\pm 5\%$

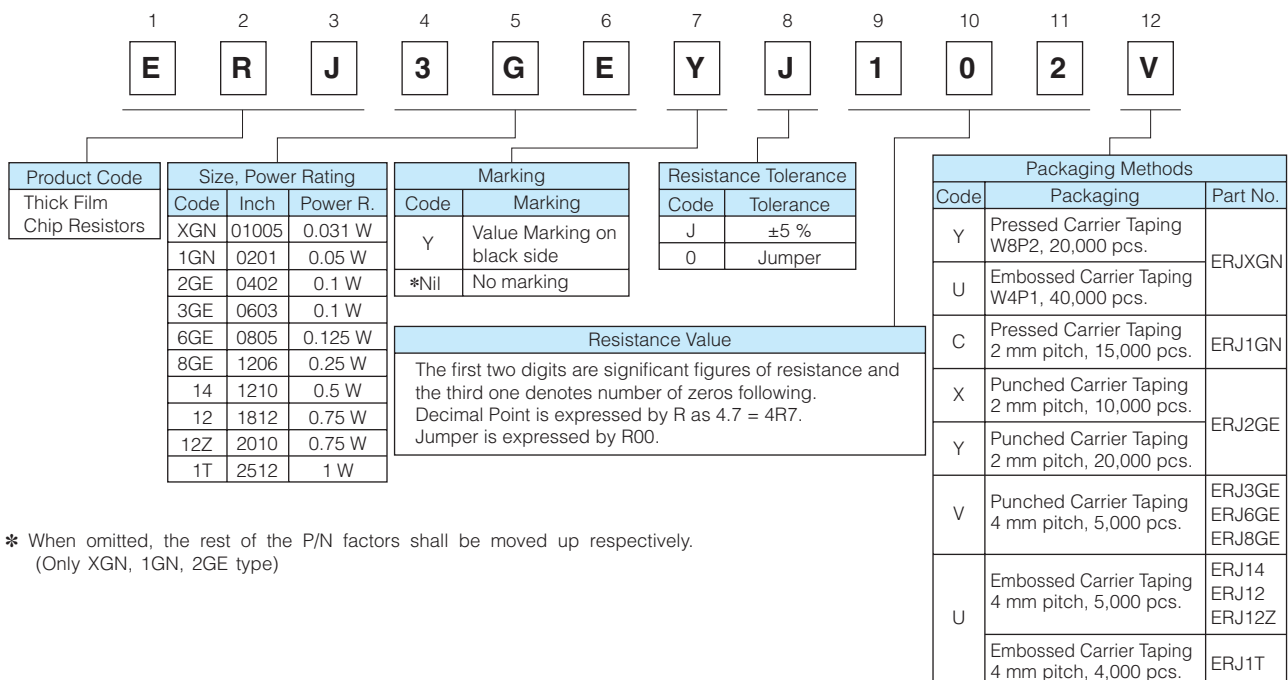

* When omitted, the rest of the P/N factors shall be moved up respectively.
(Only XGN, 1GN, 2GE type)

Construction

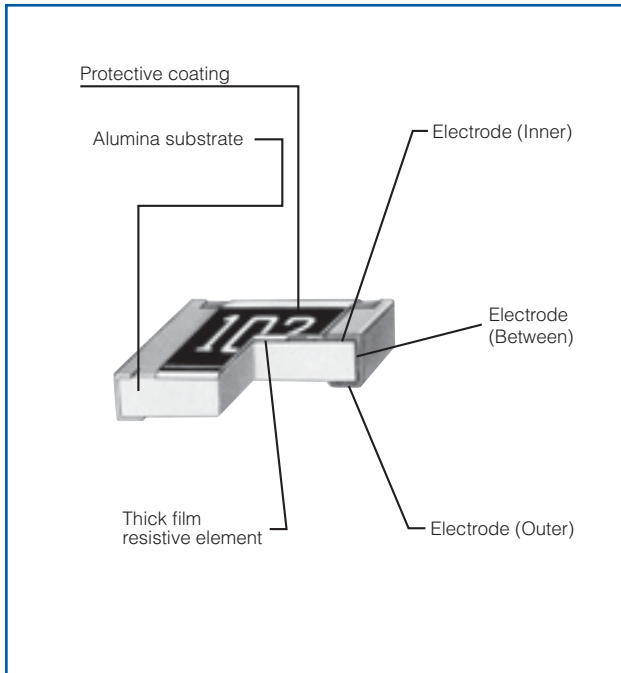

Dimensions in mm (not to scale)

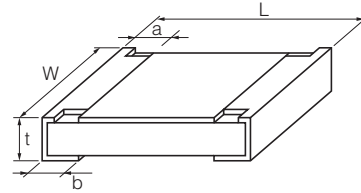

Part No. (inch size)	Dimensions (mm)					Mass (Weight) (g/1000 pcs.)
	L	W	a	b	t	
ERJXG (01005)	0.40 ^{±0.02}	0.20 ^{±0.02}	0.10 ^{±0.03}	0.10 ^{±0.03}	0.13 ^{±0.02}	0.04
ERJ1G (0201)	0.60 ^{±0.03}	0.30 ^{±0.03}	0.10 ^{±0.05}	0.15 ^{±0.05}	0.23 ^{±0.03}	0.15
ERJ2G (0402)	1.00 ^{±0.05}	0.50 ^{±0.05}	0.20 ^{±0.10}	0.25 ^{±0.05}	0.35 ^{±0.05}	0.8
ERJ3G (0603)	1.60 ^{±0.15}	0.80 ^{+0.15/-0.05}	0.30 ^{±0.20}	0.30 ^{±0.15}	0.45 ^{±0.10}	2
ERJ6G (0805)	2.00 ^{±0.20}	1.25 ^{±0.10}	0.40 ^{±0.20}	0.40 ^{±0.20}	0.60 ^{±0.10}	4
ERJ8G (1206)	3.20 ^{+0.05/-0.20}	1.60 ^{+0.05/-0.15}	0.50 ^{±0.20}	0.50 ^{±0.20}	0.60 ^{±0.10}	10
ERJ14 (1210)	3.20 ^{±0.20}	2.50 ^{±0.20}	0.50 ^{±0.20}	0.50 ^{±0.20}	0.60 ^{±0.10}	16
ERJ12 (1812)	4.50 ^{±0.20}	3.20 ^{±0.20}	0.50 ^{±0.20}	0.50 ^{±0.20}	0.60 ^{±0.10}	27
ERJ12Z (2010)	5.00 ^{±0.20}	2.50 ^{±0.20}	0.60 ^{±0.20}	0.60 ^{±0.20}	0.60 ^{±0.10}	27
ERJ1T (2512)	6.40 ^{±0.20}	3.20 ^{±0.20}	0.65 ^{±0.20}	0.60 ^{±0.20}	0.60 ^{±0.10}	45

Ratings

[For Resistor]

Part No. (inch size)	Power Rating at 70 °C (W)	Limiting Element Voltage ⁽¹⁾ (V)	Maximum Overload Voltage ⁽²⁾ (V)	Resistance Tolerance (%)	Resistance Range (Ω)	T.C.R. (×10 ⁻⁶ /°C)	Category Temperature Range (°C)
ERJXG (01005)	0.031	15	30	±5	4.7 to 1 M (E24)	<10 Ω: -100 to +600 10 Ω to 100 Ω: ±300 100 Ω <: ±200	-55 to +125
ERJ1G (0201)	0.05	25	50	±5	1 to 10 M (E24)	<10 Ω: -100 to +600	-55 to +125
ERJ2G (0402)	0.1	50	100	±5	1 to 10 M (E24)		-55 to +155
ERJ3G (0603)	0.1	75	150	±5	1 to 10 M (E24)	10 Ω to 1 M Ω: ±200	-55 to +155
ERJ6G (0805)	0.125	150	200	±5	1 to 10 M (E24)		-55 to +155
ERJ8G (1206)	0.25	200	400	±5	1 to 10 M (E24)		-55 to +155
ERJ14 (1210)	0.5	200	400	±5	1 to 10 M (E24)	1 M Ω <: -400 to +150	-55 to +155
ERJ12 (1812)	0.75	200	500	±5	1 to 10 M (E24)		-55 to +155
ERJ12Z (2010)	0.75	200	500	±5	1 to 10 M (E24)	-400 to +150	-55 to +155
ERJ1T (2512)	1	200	500	±5	1 to 1 M (E24)		-55 to +155

(1) Rated Continuous Working Voltage (RCWV) shall be determined from $RCWV = \sqrt{\text{Power Rating} \times \text{Resistance Values}}$, or Limiting Element Voltage listed above, whichever less.

(2) Overload (Short-time Overload) Test Voltage (SOTV) shall be determined from $SOTV = 2.5$ (Only ERJ2G=2.0) × Power Rating or max. Overload Voltage listed above whichever less.

[For Jumper]

Part No. (inch size)	Rated Current (A)	Maximum Overload Current (A)
ERJXG (01005)	0.5	1
ERJ1G (0201)		
ERJ2G (0402)		
ERJ3G (0603)	1	2
ERJ6G (0805)		
ERJ8G (1206)	2	4
ERJ14 (1210)		
ERJ12 (1812)		
ERJ12Z (2010)		
ERJ1T (2512)		

Power Derating Curve

For resistors operated in ambient temperatures above 70 °C, power rating shall be derated in accordance with the figure below.

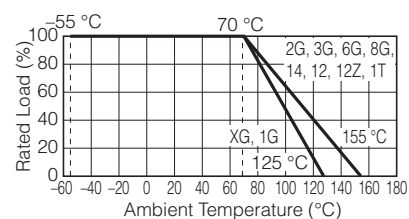

Precision Thick Film Chip Resistors

Type: **ERJ XG, 1G**
ERJ 1R, 2R, 3R, 6R
ERJ 3E, 6E, 8E, 14, 12, 1T



Features

- Small size and lightweight
- High reliability
Metal glaze thick film resistive element and three layers of electrodes
- Compatible with placement machines
Taping packaging available
- Suitable for both reflow and flow soldering
- Low Resistance Tolerance
ERJXG, 1G, 2R, 3E, 6E, 8E, 14, 12, 1T Type : ±1 %
ERJ1R, 2R, 3R, 6R Type : ±0.5 %
- Reference Standards
IEC 60115-8, JIS C 5201-8, EIAJ RC-2134B
- AEC-Q200 qualified (Exemption ERJXG, ERJ1R)
- RoHS compliant

■ **As for Packaging Methods, Land Pattern, Soldering Conditions and Safety Precautions,**
 Please see Data Files

Explanation of Part Numbers

- ERJ1R, 2R, 3R, 6R Type, ±0.5 %

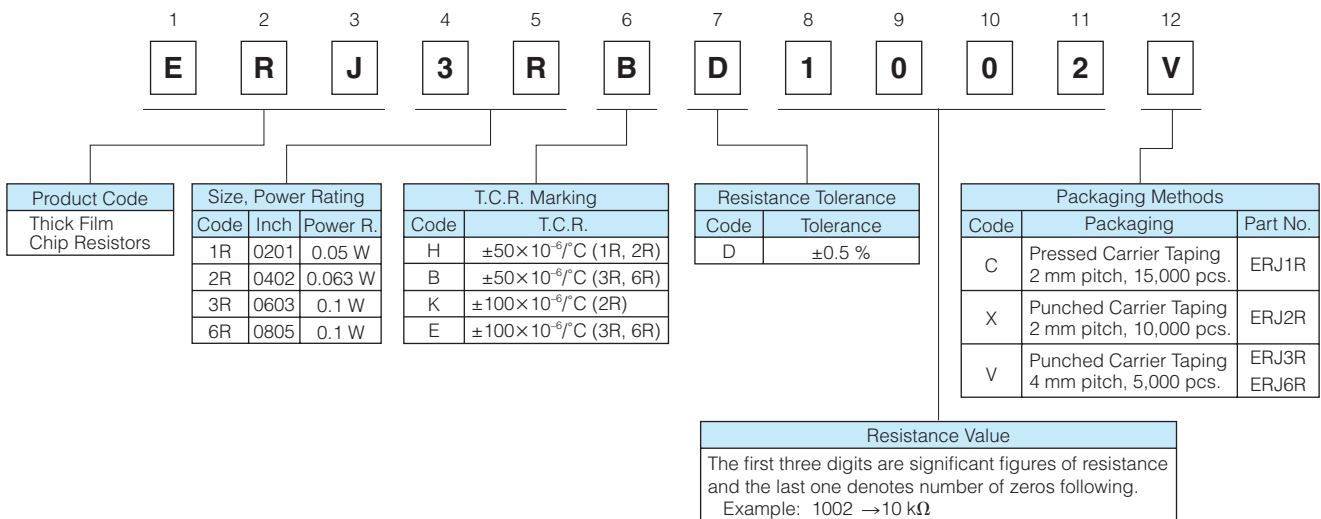

● ERJXG, 1G, 2R, 3E, 6E, 8E, 14, 12, 1T Type, $\pm 1\%$

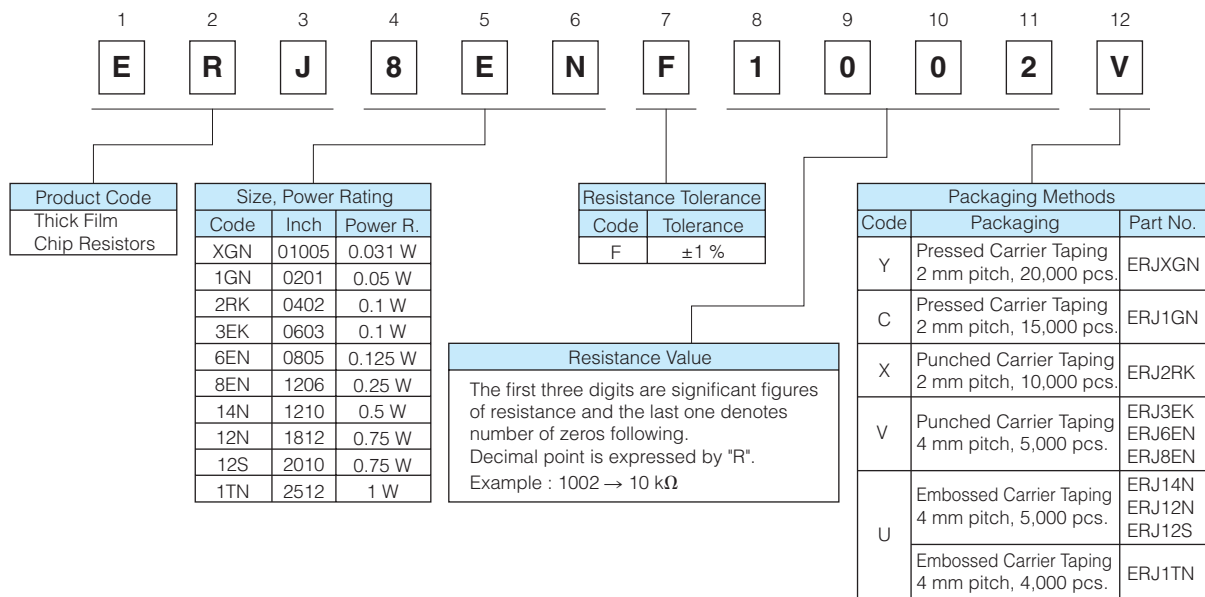

Construction

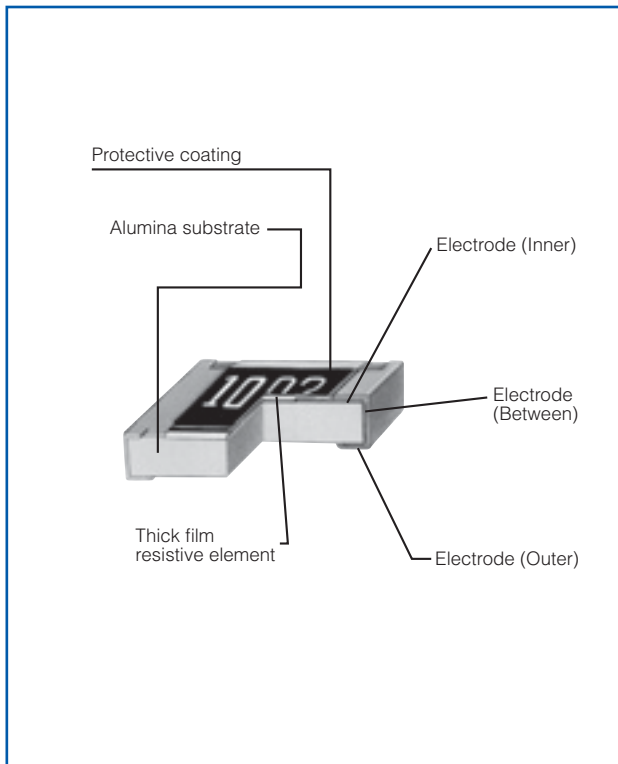

Dimensions in mm (not to scale)

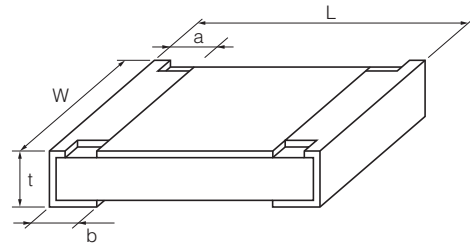

Part No. (inch size)	Dimensions (mm)					Mass (Weight) [g/1000 pcs.]
	L	W	a	b	t	
ERJXG (01005)	0.40 $^{+0.02}$	0.20 $^{+0.02}$	0.10 $^{+0.03}$	0.10 $^{+0.03}$	0.13 $^{+0.02}$	0.04
ERJ1G, 1R (0201)	0.60 $^{+0.03}$	0.30 $^{+0.03}$	0.10 $^{+0.05}$	0.15 $^{+0.05}$	0.23 $^{+0.03}$	0.15
ERJ2R□ (0402)	1.00 $^{+0.05}$	0.50 $^{+0.05}$	0.20 $^{+0.10}$	0.25 $^{+0.05}$	0.35 $^{+0.05}$	0.8
ERJ3R□ ERJ3EK (0603)	1.60 $^{+0.15}$	0.80 $^{+0.15}$ $^{-0.05}$	0.30 $^{+0.20}$	0.30 $^{+0.15}$	0.45 $^{+0.10}$	2
ERJ6R□ ERJ6EN (0805)	2.00 $^{+0.20}$	1.25 $^{+0.10}$	0.40 $^{+0.20}$	0.40 $^{+0.20}$	0.60 $^{+0.10}$	4
ERJ8EN (1206)	3.20 $^{+0.05}$ $^{-0.20}$	1.60 $^{+0.05}$ $^{-0.15}$	0.50 $^{+0.20}$	0.50 $^{+0.20}$	0.60 $^{+0.10}$	10
ERJ14N (1210)	3.20 $^{+0.20}$	2.50 $^{+0.20}$	0.50 $^{+0.20}$	0.50 $^{+0.20}$	0.60 $^{+0.10}$	16
ERJ12N (1812)	4.50 $^{+0.20}$	3.20 $^{+0.20}$	0.50 $^{+0.20}$	0.50 $^{+0.20}$	0.60 $^{+0.10}$	27
ERJ12S (2010)	5.00 $^{+0.20}$	2.50 $^{+0.20}$	0.60 $^{+0.20}$	0.60 $^{+0.20}$	0.60 $^{+0.10}$	27
ERJ1TN (2512)	6.40 $^{+0.20}$	3.20 $^{+0.20}$	0.65 $^{+0.20}$	0.60 $^{+0.20}$	0.60 $^{+0.10}$	45

Ratings

<±0.5 %>

Part No. (inch size)	Power Rating at 70 °C (W)	Limiting Element Voltage ⁽¹⁾ (V)	Maximum Overload Voltage ⁽²⁾ (V)	Resistance Tolerance (%)	Resistance Range (Ω)	T.C.R. (×10 ⁻⁶ /°C)	Category Temperature Range (°C)
ERJ1RH (0201)	0.05	15	30	±0.5	1 k to 1 M (E24, E96)	±50	-55 to +125
ERJ2RH (0402)	0.063	50	100	±0.5	100 to 100 k (E24, E96)	±50	-55 to +125
ERJ2RK (0402)	0.063	50	100	±0.5	10 to 97.6 102 k to 1 M (E24, E96)	±100	-55 to +125
ERJ3RB (0603)	0.1	50	100	±0.5	100 to 100 k (E24, E96)	±50	-55 to +125
ERJ3RE (0603)	0.1	50	100	±0.5	10 to 97.6 102 k to 1 M (E24, E96)	±100	-55 to +125
ERJ6RB (0805)	0.1	150	200	±0.5	100 to 100 k (E24, E96)	±50	-55 to +125
ERJ6RE (0805)	0.1	150	200	±0.5	10 to 97.6 102 k to 1 M (E24, E96)	±100	-55 to +125

<±1 %>

Part No. (inch size)	Power Rating at 70 °C (W)	Limiting Element Voltage ⁽¹⁾ (V)	Maximum Overload Voltage ⁽²⁾ (V)	Resistance Tolerance (%)	Resistance Range (Ω)	T.C.R. (×10 ⁻⁶ /°C)	Category Temperature Range (°C)
ERJXGN (01005)	0.031	15	30	±1	10 to 1 M (E24, E96)	<100 Ω : ±300 100 Ω ≤ : ±200	-55 to +125
ERJ1GN (0201)	0.05	25	50	±1	10 to 1 M ⁽³⁾ (E24, E96)	±200	-55 to +125
ERJ2RK (0402)	0.1	50	100	±1	10 to 1 M ⁽³⁾ (E24, E96)	±100	-55 to +155
ERJ3EK (0603)	0.1	75	150	±1	10 to 1 M (E24, E96)	±100	-55 to +155
ERJ6EN (0805)	0.125	150	200	±1	10 to 2.2 M (E24, E96)	±100	-55 to +155
ERJ8EN (1206)	0.25	200	400	±1	10 to 2.2 M (E24, E96)	±100	-55 to +155
ERJ14N (1210)	0.5	200	400	±1	10 to 1 M (E24, E96)	±100	-55 to +155
ERJ12N (1812)	0.75	200	500	±1	10 to 1 M (E24, E96)	±100	-55 to +155
ERJ12S (2010)	0.75	200	500	±1	10 to 1 M (E24, E96)	±100	-55 to +155
ERJ1TN (2512)	1	200	500	±1	10 to 1 M (E24, E96)	±100	-55 to +155

(1) Rated Continuous Working Voltage (RCWV) shall be determined from $RCWV = \sqrt{\text{Power Rating} \times \text{Resistance Values}}$, or Limiting Element Voltage listed above, whichever less.

(2) Overload (Short-time Overload) Test Voltage (SOTV) shall be determined from $SOTV = 2.5$ (Only ERJ2RK ±1% =2.0) × Power Rating or max. Overload Voltage listed above whichever less.

(3) Please contact us when you need a type with a resistance of less than 10 Ω.

Power Derating Curve

For resistors operated in ambient temperatures above 70 °C, power rating shall be derated in accordance with the figure on the right.

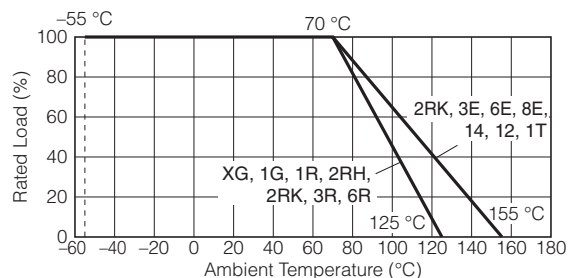

Metal Film (Thin Film) Chip Resistors, High Reliability Type

Type: **ERA 1A, 2A, 3A, 6A, 8A**

Features

- High reliability Stable at high temperature and humidity
(85 °C 85 %RH rated load, Category temperature range : -55 to +155 °C)
- High accuracy Small resistance tolerance and Temperature Coefficient of Resistance
- High performance Low current noise, excellent linearity
- Reference Standard IEC 60115-8, JIS C 5201-8, EIAJ RC-2133B
- AEC-Q200 qualified
- RoHS compliant

■ **As for Packaging Methods, Land Pattern, Soldering Conditions and Safety Precautions,**
Please see Data Files

Explanation of Part Numbers

- E24 Series

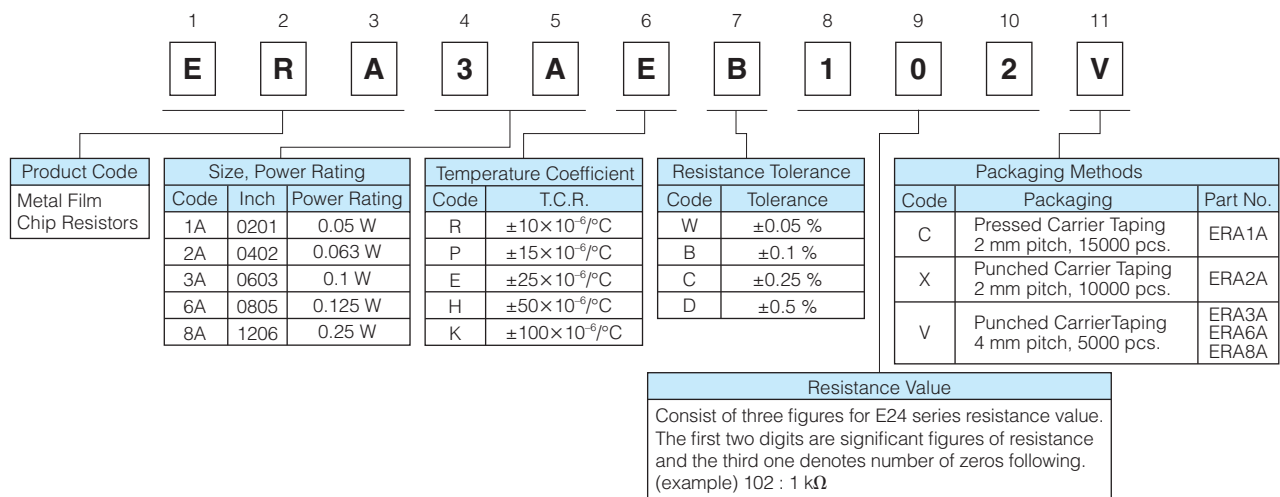

- E96 Series and other Resistance values

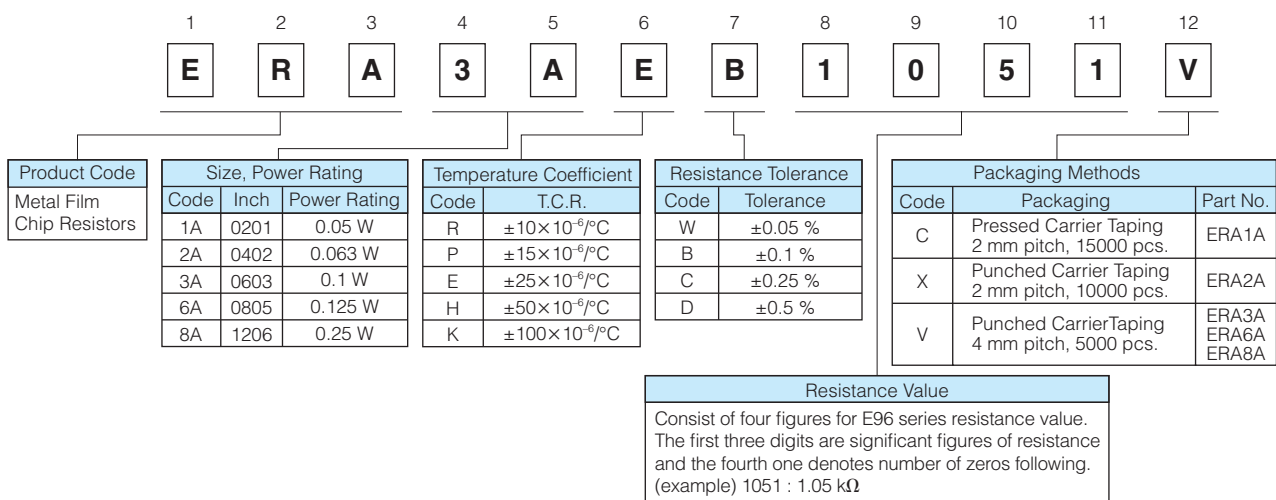

note : Duplicated resistance values as E24 series part numbers shall follow E24 part numbers.
(apply three digit resistance value)

Construction

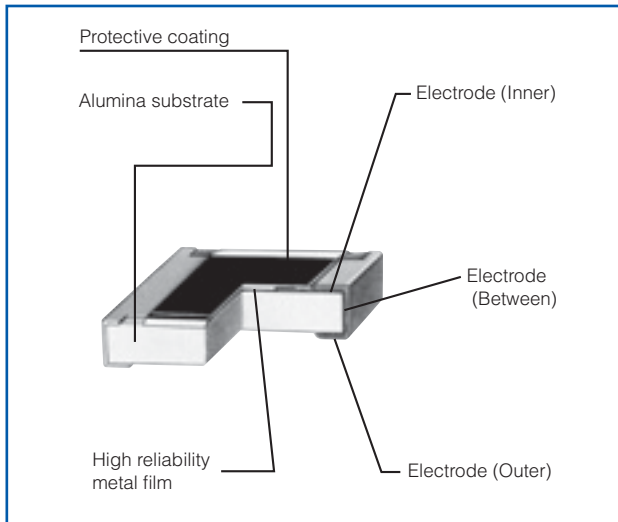

Dimensions in mm (not to scale)

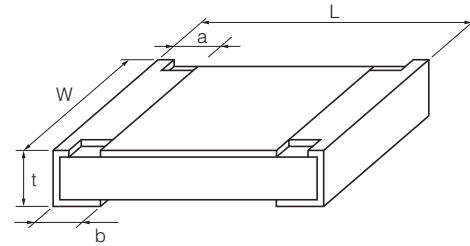

Part No. (inch size)	Dimensions (mm)					Mass (Weight) [g/1000 pcs.]
	L	W	a	b	t	
ERA1A (0201)	0.60 ^{±0.03}	0.30 ^{±0.03}	0.15 ^{±0.05}	0.15 ^{±0.05}	0.23 ^{±0.03}	0.14
ERA2A (0402)	1.00 ^{±0.10}	0.50 ^{+0.10/-0.05}	0.15 ^{±0.10}	0.25 ^{±0.10}	0.35 ^{±0.05}	0.6
ERA3A (0603)	1.60 ^{±0.20}	0.80 ^{±0.20}	0.30 ^{±0.20}	0.30 ^{±0.20}	0.45 ^{±0.10}	2
ERA6A (0805)	2.00 ^{±0.20}	1.25 ^{±0.10}	0.40 ^{±0.25}	0.40 ^{±0.25}	0.50 ^{±0.10}	4
ERA8A (1206)	3.20 ^{±0.20}	1.60 ^{+0.05/-0.15}	0.50 ^{±0.25}	0.50 ^{±0.25}	0.60 ^{±0.10}	8

Ratings

Part No. (inch size)	Power Rating at 85 °C (W)	Limiting Element Voltage ⁽¹⁾ (V)	Maximum Overload Voltage ⁽²⁾ (V)	Part No. (detail)	Resistance Tolerance (%)	T.C.R. (×10 ⁻⁶ /°C)	Resistance Range ⁽³⁾⁽⁴⁾ (Ω)	Category Temperature Range (°C)
ERA1A (0201)	0.05	25	50	ERA1AEB	±0.1	±25	100 to 10 k (E24, E96)	-55 to +155
				ERA1AEC	±0.25			
ERA2A (0402)	0.063	50	100	ERA2AKD	±0.5	±100	10 to 46.4 (E24, E96)	
				ERA2AED	±0.5	±25	47 to 100 k (E24, E96)	
				ERA2AEB	±0.1	±15	200 to 47 k (E24, E96)	
				ERA2APB	±0.1	±15	200 to 47 k (E24, E96)	
				ERA2ARC	±0.25	±10	200 to 47 k (E24, E96)	
				ERA2ARB	±0.1	±10	200 to 47 k (E24, E96)	
ERA3A (0603)	0.1	75	150	ERA3AHD	±0.5	±50	10 to 46.4 (E24, E96)	
				ERA3AED	±0.5	±25	47 to 330 k (E24, E96)	
				ERA3AEB	±0.1	±15	470 to 100 k (E24, E96)	
				ERA3APB	±0.1	±15	470 to 100 k (E24, E96)	
				ERA3ARB	±0.1	±10	1 k to 100 k (E24, E96)	
				ERA3ARW	±0.05	±10	1 k to 100 k (E24, E96)	
ERA6A (0805)	0.125	100	200	ERA6AHD	±0.5	±50	10 to 46.4 (E24, E96)	
				ERA6AED	±0.5	±25	47 to 1 M (E24, E96)	
				ERA6AEB	±0.1	±15	470 to 100 k (E24, E96)	
				ERA6APB	±0.1	±15	470 to 100 k (E24, E96)	
				ERA6ARB	±0.1	±10	1 k to 100 k (E24, E96)	
				ERA6ARW	±0.05	±10	1 k to 100 k (E24, E96)	
ERA8A (1206)	0.25	150	300	ERA8AHD	±0.5	±50	10 to 46.4 (E24, E96)	
				ERA8AED	±0.5	±25	47 to 1 M (E24, E96)	
				ERA8AEB	±0.1	±15	470 to 100 k (E24, E96)	
				ERA8APB	±0.1	±15	470 to 100 k (E24, E96)	
				ERA8ARB	±0.1	±10	1 k to 100 k (E24, E96)	
				ERA8ARW	±0.05	±10	1 k to 100 k (E24, E96)	

(1) Rated Continuous Working Voltage (RCWV) shall be determined from $RCWV = \sqrt{\text{Rated Power} \times \text{Resistance Values}}$, or Limiting Element Voltage listed above, whichever less.

(2) Overload (Short-time Overload) Test Voltage (SOTV) shall be determined from $SOTV = 2.5 \times \text{Power Rating}$ or max. Overload Voltage listed above whichever less.

(3) E192 series resistance values are also available. Please contact us for details.

(4) Duplicated resistance values between E96, E192 and E24 series shall follow E24 Part Numbers. (apply three digit resistance value)

Power Derating Curve

For resistors operated in ambient temperatures above 85 °C, power rating shall be derated in accordance with the figure on the right.

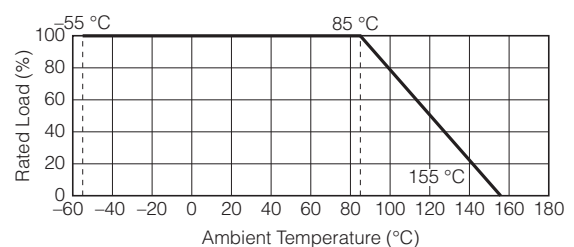

Thick Film Chip Resistors / Low Resistance Type

Type: **ERJ 2LW, 3LW**
2BW, 3BW, 6BW,
8BW, 8CW
ERJ 2B, 3B, 6B, 8B, 14B,
3R, 6R, 8R, 14R,
12R, 12Z, 1TR
ERJ L03, L06, L08, L14,
L12, L1D, L1W



Features

- Current Sensing resistor
- Small size and lightweight
- High reliability : Metal glaze thick film resistive element and three layers of electrodes
- Suitable for both reflow and flow soldering
- Improved high-power/resistance to pulse characteristics
by double-sided resistive elements structure : ERJ2LW, 3LW ,2BW, 3BW, 6BW, 8BW, 8CW
- Low TCR : $\pm 50 \times 10^{-6} / ^\circ\text{C}$ (ERJ8CW)
- Low Resistance Value
 - 5 m Ω , 10 m Ω : ERJ3LW
 - 10 m Ω : ERJ2LW
 - 10 m Ω to 50 m Ω : ERJ8CW
 - 10 m Ω to 100 m Ω : ERJ6BW, 8BW
 - 20 m Ω to 100 m Ω : ERJ3BW, ERJL14, L12
 - 40 m Ω to 100 m Ω : ERJL1D, L1W
 - 47 m Ω to 100 m Ω : ERJ2BW, ERJL03, L06, L08
- Reference Standards : IEC 60115-8, JIS C 5201-8, JEITA RC-2144
- AEC-Q200 qualified
- RoHS compliant

■ **As for Packaging Methods, Land Pattern, Soldering Conditions and Safety Precautions,**
Please see Data Files

Explanation of Part Numbers

- ERJ2LW, 3LW, 2BW, 3BW, 6BW, 8BW, 8CW <High power (double-sided resistive elements structure) type>

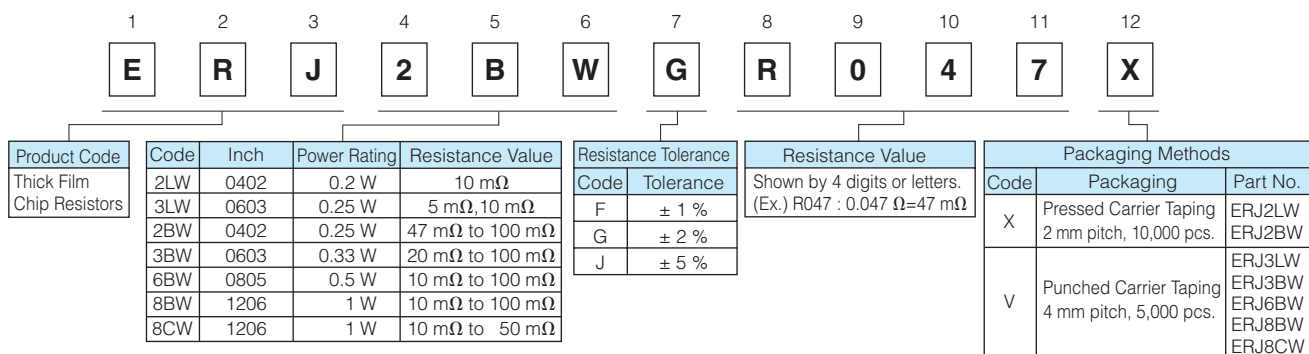

● ERJ2BS/2BQ, 3BS/3BQ, 6BS/6BQ, 8BS/8BQ, 14BS/14BQ, 3R, 6R, 8R, 14R, 12R, 12Z, 1TR <High power type/Standard type>

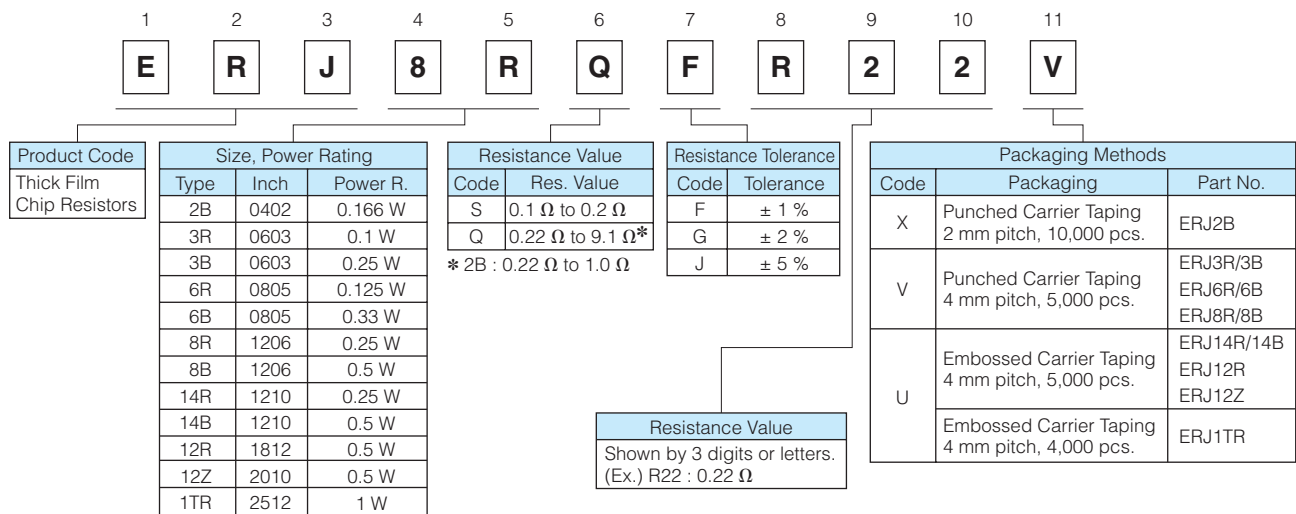

● ERJL03, L06, L08, L14, L12, L1D, L1W <Low TCR type>

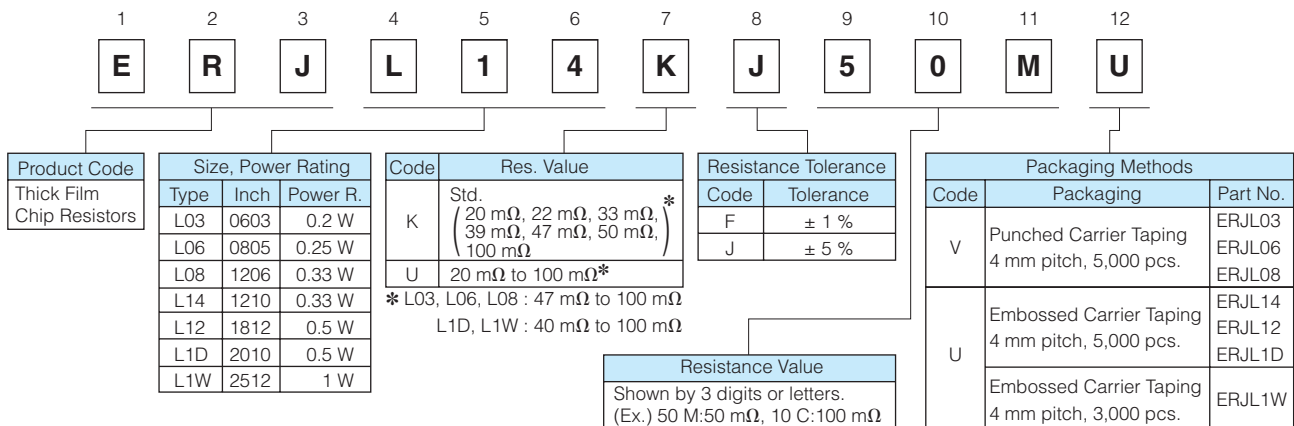

Ratings

<High power (double-sided resistive elements structure) type>

Part No. (inch size)	Power Rating at 70 °C (W)	Resistance Tolerance (%)	Resistance ⁽¹⁾ Range (Ω)	T.C.R. (×10 ⁻⁶ /°C)	Category Temperature Range (°C)
ERJ2LW (0402)	0.2	±1, ±2, ±5	10 m	0 to 500	-55 to +125
ERJ3LW (0603)	0.25	±1, ±2, ±5	5 m	0 to 700	-55 to +125
			10 m	0 to 300	-55 to +125
ERJ2BW (0402)	0.25	±1, ±2, ±5	47 m to 100 m (E24)	±300	-55 to +155
ERJ3BW (0603)	0.33	±1, ±2, ±5	20 m to 100 m (E24)	R<39m Ω : ±250 R≥39m Ω : ±150	-55 to +155
ERJ6BW (0805)	0.5	±1, ±2, ±5	10 m to 100 m (E24)	R<15m Ω : ±300 R≥15m Ω : ±200	-55 to +155
ERJ8BW (1206)	1	±1, ±2, ±5	10 m to 100 m (E24)	10 mΩ ≤ R < 20 mΩ : ±200 20 mΩ ≤ R < 47 mΩ : ±150 47 mΩ ≤ R ≤ 100 mΩ : ±100	-55 to +155
ERJ8CW (1206)	1	±1, ±2, ±5	10 m to 50 m (E24)	±50	-55 to +155 (10 m to 33 mΩ) -55 to +125 (36 m to 50 mΩ)

(1) Please contact us when resistors of irregular series are needed.

Ratings

<High power type>

Part No. (inch size)	Power Rating at 70 °C (W)	Resistance Tolerance (%)	Resistance ⁽¹⁾ Range (Ω)	T.C.R. (×10 ⁻⁶ /°C)	Category Temperature Range (°C)
ERJ2BS (0402)	0.166	±1, ±2, ±5	0.10 to 0.20 (E24)	±300	-55 to +125
ERJ2BQ (0402)			0.22 to 1.0 (E24)	±250	
ERJ3BS (0603)	0.25	±1, ±2, ±5	0.10 to 0.20 (E24)	±300	-55 to +125
ERJ3BQ (0603)			0.22 to 0.91 (E24)		
			1.0 to 9.1 (E24)	±200	
ERJ6BS (0805)	0.33	±1, ±2, ±5	0.10 to 0.20 (E24)	±250	-55 to +125
ERJ6BQ (0805)			0.22 to 0.91 (E24)		
			1.0 to 9.1 (E24)	±200	
ERJ8BS (1206)	0.5	±1, ±2, ±5	0.10 to 0.20 (E24)	±250	-55 to +125
ERJ8BQ (1206)			0.22 to 0.91 (E24)		
			1.0 to 9.1 (E24)	±200	
ERJ14BS (1210)	0.5	±1, ±2, ±5	0.10 to 0.20 (E24)	±200	-55 to +125
ERJ14BQ (1210)			0.22 to 0.91 (E24)		
			1.0 to 9.1 (E24)	±100	

(1) Please contact us when resistors of irregular series are needed.

<Standard type>

Part No. (inch size)	Power Rating at 70 °C (W)	Resistance Tolerance (%)	Resistance Range (Ω)	T.C.R. (×10 ⁻⁶ /°C)	Category Temperature Range (°C)
ERJ3RS (0603)	0.1	±1, ±2, ±5	0.10 to 0.20 (E24)	±300	-55 to +125
ERJ3RQ (0603)			0.22 to 0.91 (E24)		
			1.0 to 9.1 (E24)	±200	
ERJ6RS (0805)	0.125	±1, ±2, ±5	0.10 to 0.20 (E24)	±250	-55 to +125
ERJ6RQ (0805)			0.22 to 0.91 (E24)		
			1.0 to 9.1 (E24)	±200	
ERJ8RS (1206)	0.25	±1, ±2, ±5	0.10 to 0.20 (E24)	±250	-55 to +125
ERJ8RQ (1206)			0.22 to 0.91 (E24)		
			1.0 to 9.1 (E24)	±200	
ERJ14RS (1210)	0.25	±1, ±2, ±5	0.10 to 0.20 (E24)	±200	-55 to +125
ERJ14RQ (1210)			0.22 to 0.91 (E24)		
			1.0 to 9.1 (E24)	±100	
ERJ12RS (1812)	0.5	±1, ±2, ±5	0.10 to 0.20 (E24)	±200	-55 to +125
ERJ12RQ (1812)			0.22 to 0.91 (E24)		
			1.0 to 9.1 (E24)	±100	
ERJ12ZS (2010)	0.5	±1, ±2, ±5	0.10 to 0.20 (E24)	±200	-55 to +125
ERJ12ZQ (2010)			0.22 to 0.91 (E24)		
			1.0 to 9.1 (E24)	±100	
ERJ1TRS (2512)	1	±1, ±2, ±5	0.10 to 0.20 (E24)	±200	-55 to +125
ERJ1TRQ (2512)			0.22 to 0.91 (E24)		
			1.0 to 9.1 (E24)	±100	

<Low TCR type>

Part No. (inch size)	Power Rating at 70 °C (W)	Resistance Tolerance (%)	Resistance ⁽¹⁾ Range (Ω)	T.C.R. (×10 ⁻⁶ /°C)	Category Temperature Range (°C)
ERJL03 (0603)	0.2	±1, ±5	47 m to 100 m	±200	-55 to +125
ERJL06 (0805)	0.25	±1, ±5	47 m to 100 m	±100	-55 to +125
ERJL08 (1206)	0.33	±1, ±5	47 m to 100 m	±100	-55 to +125
ERJL14 (1210)	0.33	±1, ±5	20 m to 100 m	R<47 mΩ : ±300 R≥47 mΩ : ±100	-55 to +125
ERJL12 (1812)	0.5	±1, ±5	20 m to 100 m		-55 to +125
ERJL1D (2010)	0.5	±1, ±5	40 m to 100 m		-55 to +125
ERJL1W (2512)	1	±1, ±5	40 m to 100 m		-55 to +125

(1) Standard R.V. : 20 mΩ, 22 mΩ, 33 mΩ, 39 mΩ, 47 mΩ, 50 mΩ, 100 mΩ, Custom R.V. : Each 1 mΩ within upper range.

Construction

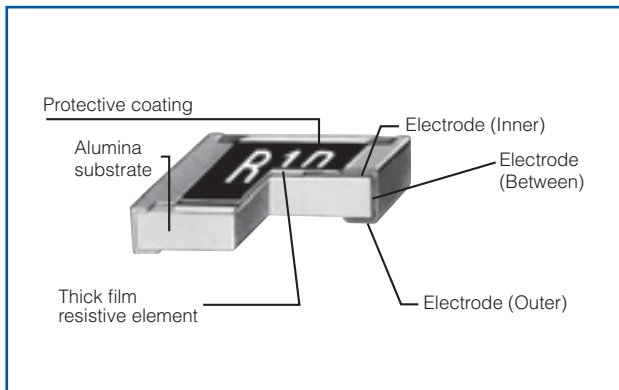

Power Derating Curve

For resistors operated in ambient temperatures above 70 °C, power rating shall be derated in accordance with the figure below.

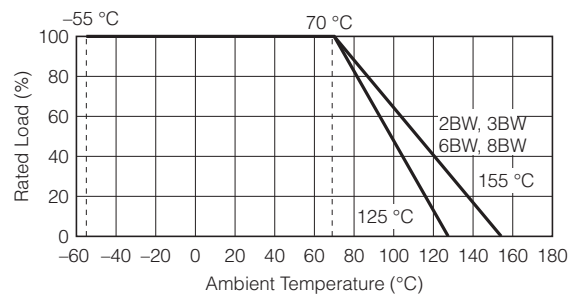

Dimensions in mm (not to scale)

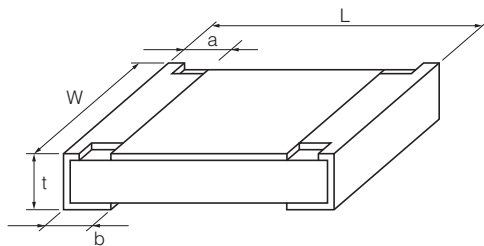

Part No. (inch size)	Dimensions (mm)					Mass(Weight) [g/1000 pcs.]
	L	W	a	b	t	
ERJ2LW (0402)	1.00 ^{+0.10}	0.50 ^{+0.10/-0.05}	0.25 ^{+0.10}	0.25 ^{+0.10}	0.40 ^{+0.05}	0.8
ERJ2BW (0402)	1.00 ^{+0.10}	0.50 ^{+0.10/-0.05}	0.24 ^{+0.10}	0.24 ^{+0.10}	0.35 ^{+0.05}	0.8
ERJ2BS ERJ2BQ (0402)	1.00 ^{+0.10}	0.50 ^{+0.10/-0.05}	0.20 ^{+0.10}	0.27 ^{+0.10}	0.35 ^{+0.05}	0.8
ERJ3LW (5 mΩ)	1.60 ^{+0.15}	0.80 ^{+0.15}	0.50 ^{+0.20}	0.50 ^{+0.20}	0.55 ^{+0.10}	3
ERJ3LW (10 mΩ) ERJ3BW	1.60 ^{+0.15}	0.80 ^{+0.15}	0.40 ^{+0.20}	0.40 ^{+0.20}	0.55 ^{+0.10}	3
ERJ3R ERJ3B (0603) ERJL03	1.60 ^{+0.15}	0.80 ^{+0.15/-0.05}	0.30 ^{+0.20}	0.30 ^{+0.15}	0.45 ^{+0.10}	2
ERJ6BW (0805)	2.00 ^{+0.20}	1.25 ^{+0.20}	0.55 ^{+0.20}	0.55 ^{+0.20}	0.65 ^{+0.10}	6
ERJ6R ERJ6B (0805) ERJL06	2.00 ^{+0.20}	1.25 ^{+0.10}	0.40 ^{+0.20}	0.40 ^{+0.20}	0.60 ^{+0.10}	4
ERJ8BW (1206)	3.20 ^{+0.20}	1.60 ^{+0.20}	1.00 ^{+0.20}	1.00 ^{+0.20}	0.65 ^{+0.10}	13
ERJ8CW (10 to 16 mΩ)	3.20 ^{+0.20}	1.60 ^{+0.20}	1.10 ^{+0.20}	1.10 ^{+0.20}	0.65 ^{+0.10}	13
ERJ8CW (18 to 50 mΩ)	3.20 ^{+0.20}	1.60 ^{+0.20}	0.60 ^{+0.20}	0.60 ^{+0.20}	0.65 ^{+0.10}	13
ERJ8R ERJ8B (1206) ERJL08	3.20 ^{+0.05/-0.20}	1.60 ^{+0.05/-0.15}	0.50 ^{+0.20}	0.50 ^{+0.20}	0.60 ^{+0.10}	10
ERJ14R ERJ14B (1210) ERJL14	3.20 ^{+0.20}	2.50 ^{+0.20}	0.50 ^{+0.20}	0.50 ^{+0.20}	0.60 ^{+0.10}	16
ERJ12R ERJL12 (1812)	4.50 ^{+0.20}	3.20 ^{+0.20}	0.50 ^{+0.20}	0.50 ^{+0.20}	0.60 ^{+0.10}	27
ERJ12Z ERJL1D (2010)	5.00 ^{+0.20}	2.50 ^{+0.20}	0.60 ^{+0.20}	0.60 ^{+0.20}	0.60 ^{+0.10}	27
ERJ1TR ERJL1W (2512)	6.40 ^{+0.20}	3.20 ^{+0.20}	0.65 ^{+0.20}	0.60 ^{+0.20}	0.60 ^{+0.10}	45
	6.40 ^{+0.20}	3.20 ^{+0.20}	0.65 ^{+0.20}	1.30 ^{+0.20}	1.10 ^{+0.10}	79

Current Sensing Resistors, Metal Plate Type

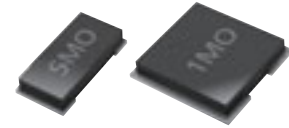

Type: ERJ MS4, MS6

Features

- Ideal for current sensing solution
- Small case size with high power
- Metal plate bonding technology. Excellent long term stability
- Outer Resin with high heat dissipation. Wide temperature range (-65 °C to +170 °C)
- AEC-Q200 qualified
- RoHS compliant

As for Packaging Methods, Soldering Conditions and Safety Precautions,

Please see Data Files

Explanation of Part Numbers

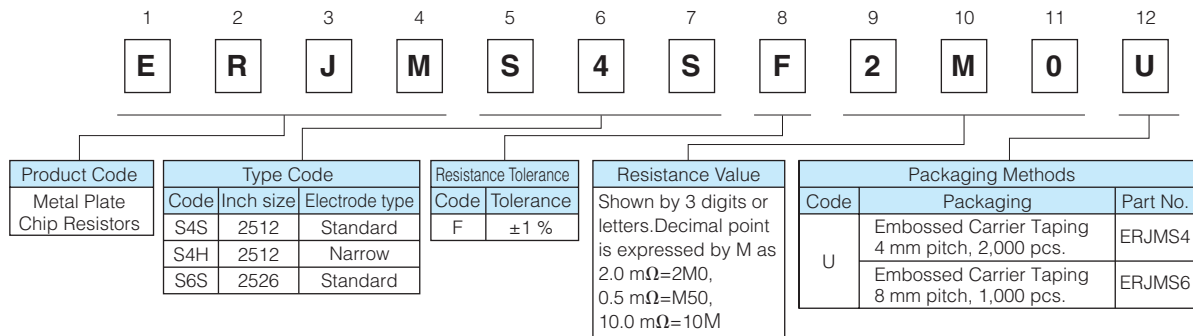

Ratings

Part No. (inch size)	Power Rating at 70 °C (W)	Resistance Range (mΩ)	Resistance Tolerance (%)	T.C.R. (×10 ⁻⁶ /°C)	Category Temperature Range (°C)	Terminal temp. upper limit (°C)
ERJMS4S (2512)	3	1, 2, 3, 4	F : ±1	±75	-65 to +170	130
ERJMS4H (2512)	3	5, 6	F : ±1	±75	-65 to +170	130
	2	7, 8, 9, 10	F : ±1	±75	-65 to +170	100
ERJMS6S (2526)	5	0.5, 1, 2	F : ±1	±75	-65 to +170	130

* Please contact us when resistors of irregular series are needed.

Power Derating Curve

If the terminal temperature of the resistor is more than terminal temperature upper limit value of the rated table, please reduce the rated power according to the Power Derating Curve shown in the figure on the right.

<Supplemented>

In the case of the temperature measurement of the terminal portion of the resistor, Please perform under the following conditions.

- 1) Terminal temperature measurement, please apply the temperature of the higher of either the left or right electrode upper surface of the resistor.
- 2) Please measure the temperature of the resistor in the land pattern printed of circuit board and plan to use by real conditions.

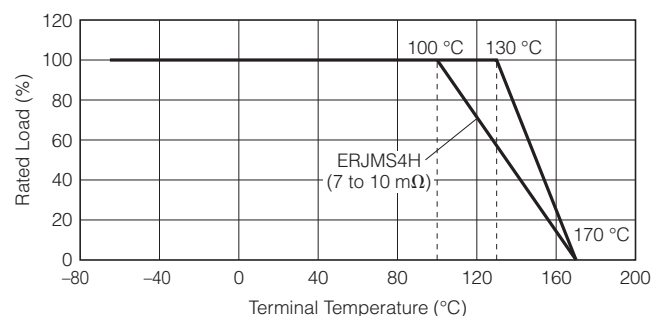

Panasonic Current Sensing Resistors, Metal Plate Type

Construction

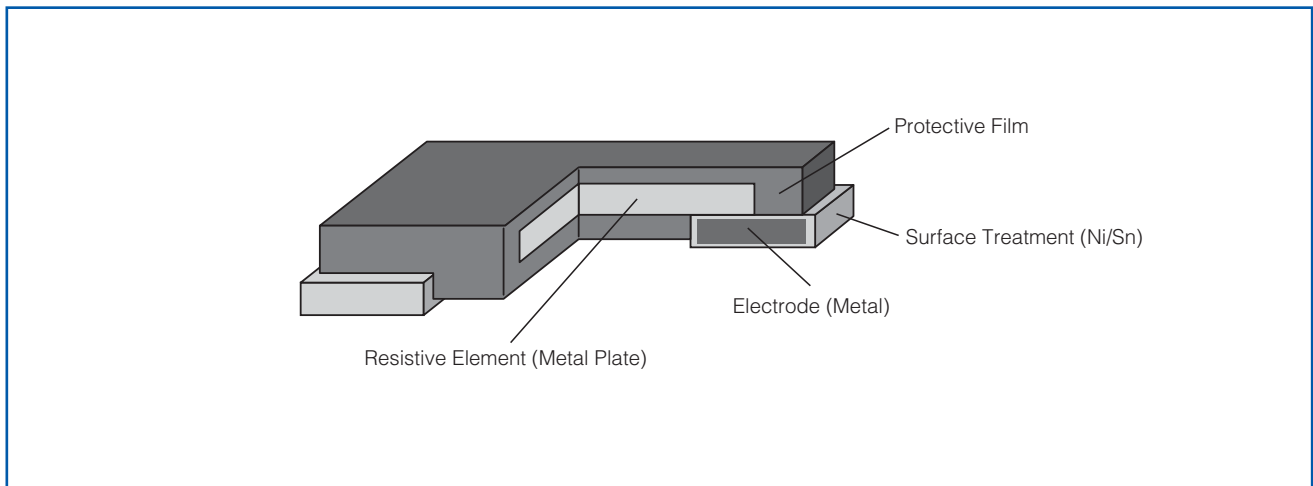

Dimensions in mm (not to scale), Recommended Land Pattern

● ERJMS4S

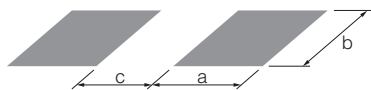
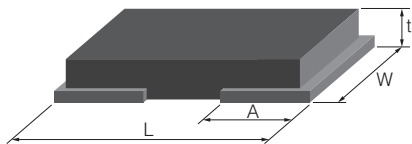

Land Pattern

● ERJMS4H

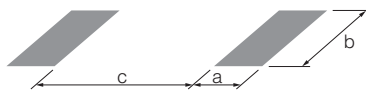
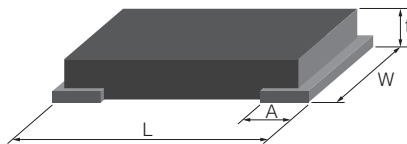

● ERJMS6S

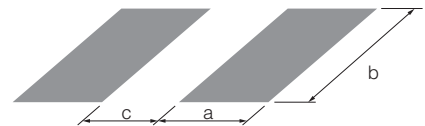
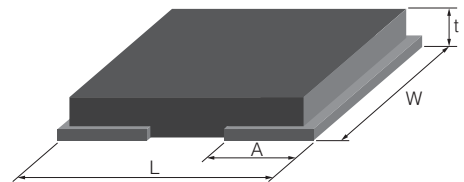

Part No. (inch size)	Dimension (mm)				Recommended Land Pattern (mm)			Mass (Weight) (g/1000 pcs.)
	L	W	A	t	a	b	c	
ERJMS4S (2512)	6.40±0.25	3.20±0.25	2.20±0.25	1.20±0.15	2.7	3.4	2.0	120
ERJMS4H (2512)	6.40±0.25	3.20±0.25	1.25±0.25	1.20±0.15	1.7	3.4	4.0	115
ERJMS6S (2526)	6.40±0.25	6.80±0.25	2.20±0.25	1.20±0.15	2.7	7.0	2.0	260

Typical Temperature dependence of electrical resistance

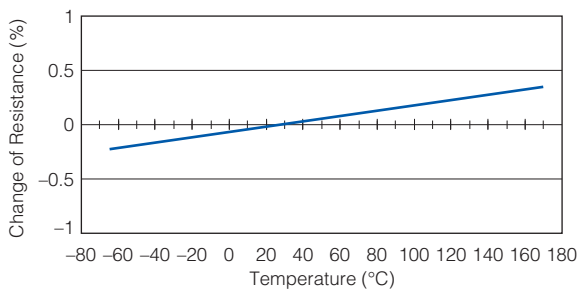

Long-term stability

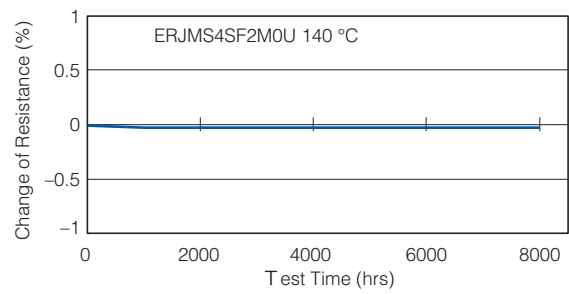

Maximum pulse energy respectively pulse power for continuous operation

● ERJMS4 type

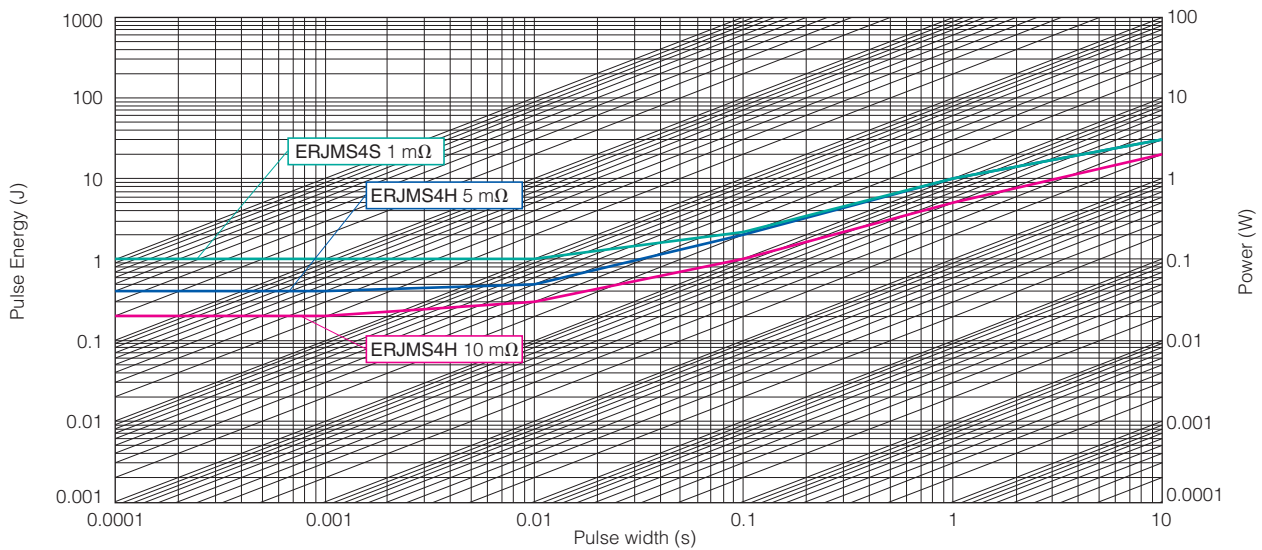

Reference Data
 Condition : Room Temperature, OFF : 10 s, 1000 cycle, Wave form : Square
 Change of Resistance = ±1 %

● ERJMS6 type

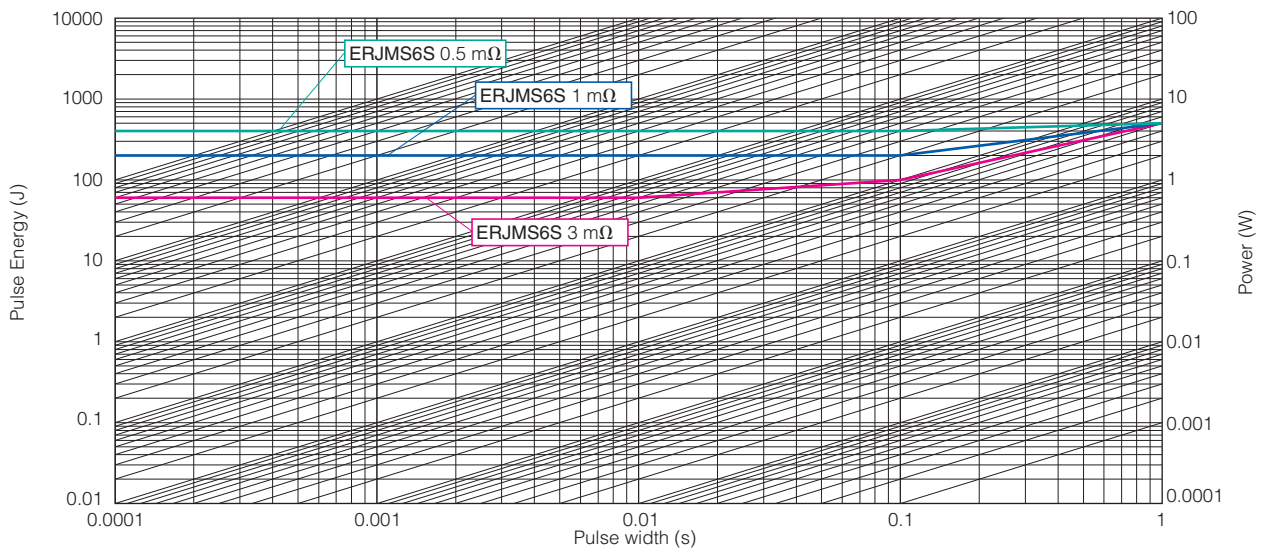

Reference Data
 Condition : Room Temperature, OFF : 10 s, 1000 cycle, Wave form : Square
 Change of Resistance = ±1 %

Performance (AEC-Q200)

● ERJMS4 type

Test Item	Test Condition	Specification	Typical value
Thermal Shock	MIL-STD-202 method 107 (-55 °C / +125 °C, 25 cycle)	±0.5 %	0.05 %
Overload	MIL-R-26E (5 x rated power, 5 sec)	±0.5 %	0.02 %
Solderability	MIL-STD-202 method 208	> 95% coverage	> 95% coverage
Resistance to Solvents	MIL-STD-202 method 215, 2.1a, 2.1d	No damage	No damage
Low Temperature Storage and Operation	MIL-STD-26E (-65 °C, 24 h)	±0.5 %	0.03 %
Resistance to Soldering Heat	MIL-STD-202 method 210 (260 °C, 10s)	±0.5 %	0.10 %
Moisture Resistance	MIL-STD-202 method 106	±0.5 %	0.20 %
Shock	MIL-STD-202 method 213-A	±0.5 %	0.10 %
Vibration, High Frequency	MIL-STD-202 method 204-B	±0.5 %	0.05 %
Life	MIL-STD-26E (Rated Power, 1.5 h-ON, 0.5 h-OFF, 2000 h)	±1 %	0.30 %
Storage Life at Elevated Temperature	MIL-STD-202 method 108-F (170 °C, 2000 h)	±1 %	0.30 %
High Temperature Characteristics	140 °C, 2000 h	±0.5 %	0.05 %
Frequency Characteristics	Inductance	< 2 nH	< 2 nH

● ERJMS6 type

Test Item	Test Condition	Specification	Typical value
Thermal Shock	MIL-STD-202 method 107 (-55 °C / +125 °C, 25 cycle)	±0.5 %	0.10 %
Overload	MIL-R-26E (5 x rated power, 5 sec)	±0.5 %	0.02 %
Solderability	MIL-STD-202 method 208	> 95% coverage	> 95% coverage
Resistance to Solvents	MIL-STD-202 method 215, 2.1a, 2.1d	No damage	No damage
Low Temperature Storage and Operation	MIL-STD-26E (-65 °C, 24 h)	±0.5 %	0.03 %
Resistance to Soldering Heat	MIL-STD-202 method 210 (260 °C, 10s)	±0.5 %	0.10 %
Moisture Resistance	MIL-STD-202 method 106	±0.5 %	0.10 %
Shock	MIL-STD-202 method 213-A	±0.5 %	0.10 %
Vibration, High Frequency	MIL-STD-202 method 204-B	±0.5 %	0.05 %
Life	MIL-STD-26E (Rated Power, 1.5 h-ON, 0.5 h-OFF, 2000 h)	±1 %	0.20 %
Storage Life at Elevated Temperature	MIL-STD-202 method 108-F (170 °C, 2000 h)	±1 %	0.30 %
High Temperature Characteristics	140 °C, 2000 h	±0.5 %	0.05 %
Frequency Characteristics	Inductance	< 2 nH	< 2 nH

Temperature Rise

● ERJMS4HF5M0U

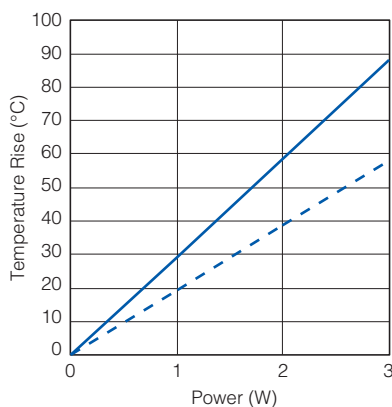

● ERJMS6SF2M0U

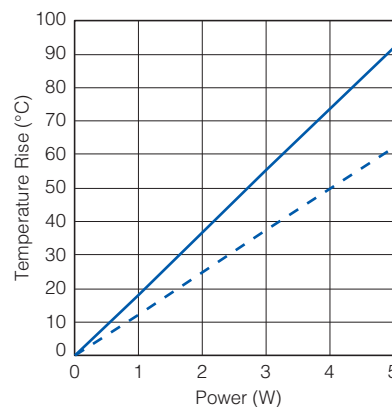

- ① ———
② - - - -

<Condition>
Base material : FR-4 (t1.6mm)
Copper Thickness : 70 μm, Two layer

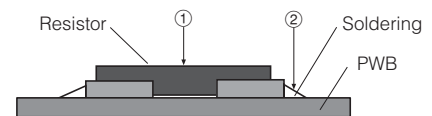

Sense terminal-Layout

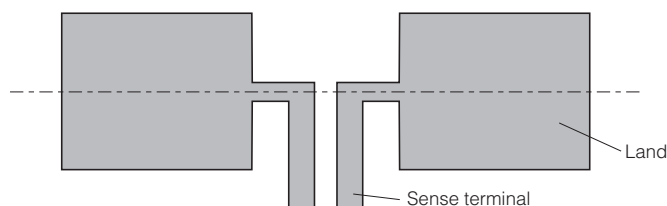

Current Sensing Resistors, Metal Plate Type

Type: **ERJM1W**



Features

- Low resistance values and high precision (1 mΩ to 20 mΩ)
- Stable resistance not influenced by measurement position
- High heat emission
- Low profile, strong body
- Inductance less than 1.0 nH for the metal plate structure
- RoHS compliant

As for Packaging Methods, Soldering Conditions and Safety Precautions,

Please see Data Files

Explanation of Part Numbers

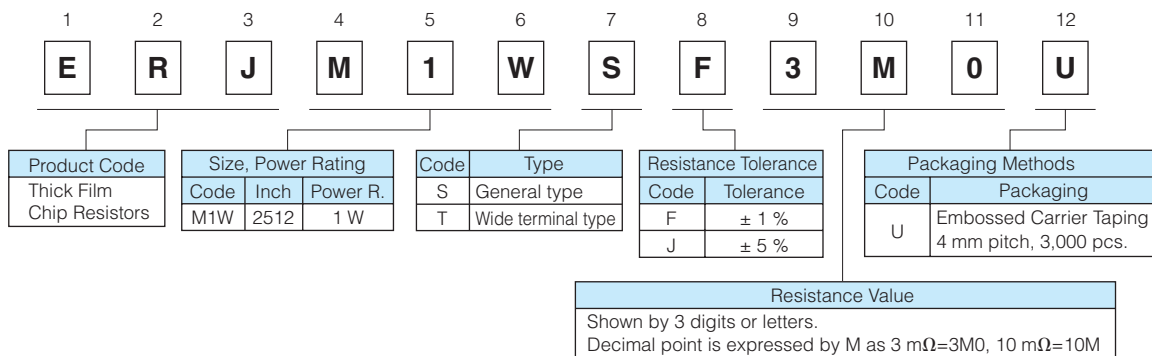

Ratings

Part No. (inch size)	Power Rating at 70 °C (W)	Standard Resistance (mΩ)	Resistance Tolerance (%)	T.C.R. (×10 ⁻⁶ /°C)	Category Temperature Range (°C)	Circuit board of use
ERJM1WS (2512)	1	3, 4	F: ±1, J: ±5	±350	-55 to +170	You should use the aluminum substrate when the added wattage exceeds 0.5 W.
		5, 6, 10, 15, 20		±100		
ERJM1WT (2512)		1, 1.5		350±100		
		2, 3, 4		100±50		

* Please contact the factory for other values and the range

Power Derating Curve

For resistors operated in ambient temperatures above 70 °C, power rating shall be derated in accordance with the figure on the right.

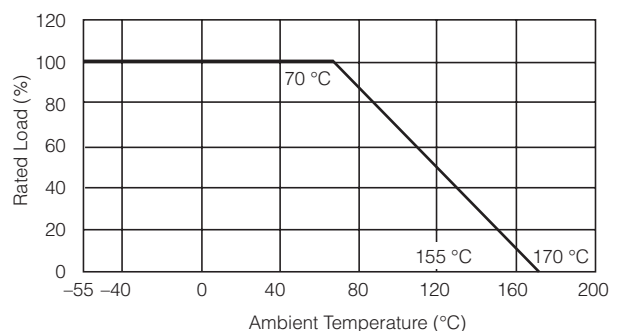

Construction

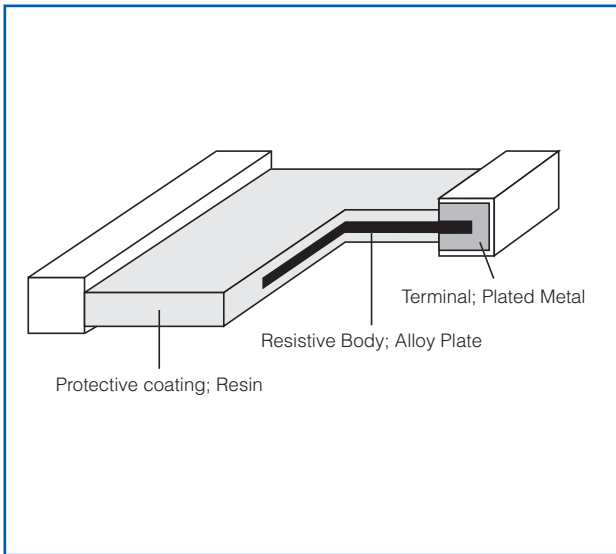

Dimensions in mm (not to scale)

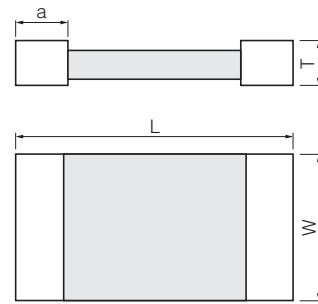

Type	Part No. (inch size)	Dimensions (mm)				Mass (Weight) [g/1000 pcs.]
		L	W	T	a	
S Type	ERJM1WS (2512)	6.40 \pm 0.25	3.20 \pm 0.25	0.80 \pm 0.30	1.00 \pm 0.25	70
T Type	ERJM1WT (2512)	6.40 \pm 0.40			2.10 \pm 0.30	

Recommended Land Pattern

- An example of a land pattern

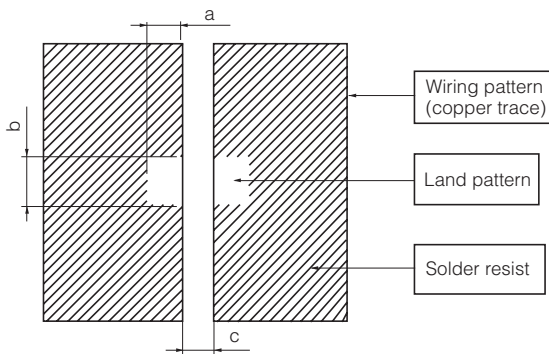

Part No.	Dimensions (mm)		
	a	b	c
ERJM1WS	2.1	3.4	4.2
ERJM1WT	3.1	3.4	2.2

High Power Chip Resistors / Wide Terminal Type



Type: **ERJ A1, B1, B2, B3**

Features

- High solder-joint reliability by wide terminal construction
- Excellent heat dissipation characteristics by wide terminal construction
- AEC-Q200 qualified
- RoHS compliant

Recommended Applications

- Automotive electronic circuits including ECUs (Electrical control unit), anti-lock breaking systems and air-bag systems
- Current sensing for power supply circuits in a variety of equipment

As for Packaging Methods, Land Pattern, Soldering Conditions and Safety Precautions,
Please see Data Files

Explanation of Part Numbers

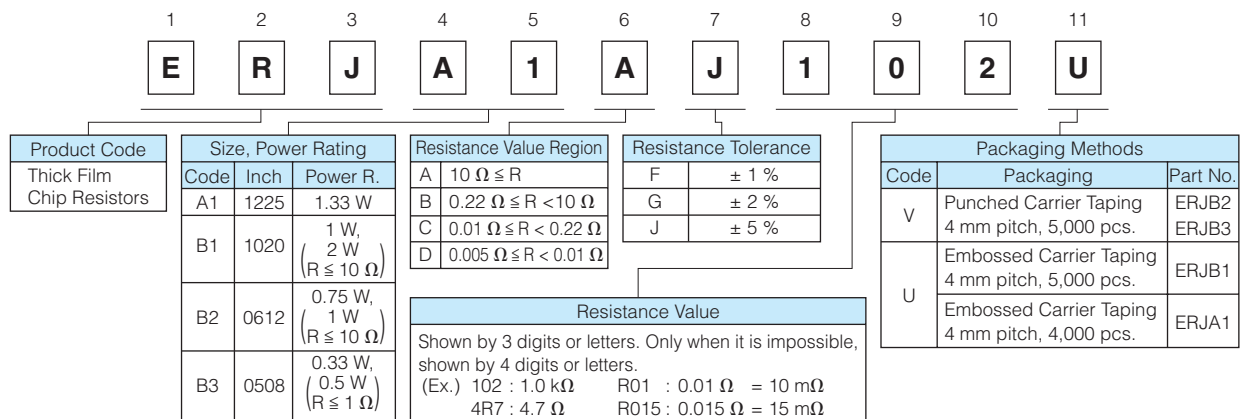

Ratings

Part No. (inch size)	Power Rating at 70 °C (W)	Limiting Element Voltage ⁽¹⁾ (V)	Maximum Overload Voltage ⁽²⁾ (V)	Resistance Tolerance (%)	Resistance Range (Ω)	T.C.R. (×10 ⁻⁶ /°C)	Category Temperature Range (°C)
ERJA1 (1225)	1.33	200	400	±1	100 m to 10 k (E24)	R < 100 mΩ : ±350	-55 to +155
				±2, ±5	10 m to 10 k (E24)	100 mΩ ≤ R : ±100 (±1%) ±200 (±2%, ±5%)	
ERJB1 (1020)	1 2(R ≤ 10 Ω)	200	400	±1, ±2, ±5	10 m to 10 k (E24)	R < 22 mΩ : ±350	-55 to +155
						22 mΩ ≤ R < 47 mΩ : ±200	
ERJB2 (0612)	0.75 1(R ≤ 10 Ω)	200	400	±1, ±2	10 m to 1 M (E24)	47 mΩ ≤ R < 100 mΩ : ±150 (±1%)	-55 to +155
						100 mΩ ≤ R : ±100 (±1%) ±200 (±2%, ±5%)	
ERJB3 (0508)	0.33 0.5(R ≤ 1 Ω)	150	200	±1, ±2, ±5	20 m to 10 (E24)	R < 22 mΩ : 0 to +300	-55 to +155
						22 mΩ ≤ R < 47 mΩ : 0 to +200	
					5 m to 1 M (5 m to 9 m : 1mΩ step) 10 m to 1 M : E24	47 mΩ ≤ R < 100 mΩ : 0 to +150	
						100 mΩ ≤ R < 220 mΩ : 0 to +150 (±1%)	
						220 mΩ ≤ R : ±100 (±1%) ±200 (±2%, ±5%)	
						R < 47 mΩ : 0 to +300	
						47 mΩ ≤ R ≤ 1 Ω : 0 to +200	
						1 Ω < R : ±100 (±1%) ±200 (±2%, ±5%)	

(1) Rated Continuous Working Voltage (RCWV) shall be determined from RCWV=√Power Rating × Resistance Values, or Limiting Element Voltage listed above, whichever less.
(2) Overload (Short-time Overload) Test Voltage (SOTV) shall be determined from SOTV=2.5 × Power Rating or max. Overload Voltage listed above whichever less.

Construction (Example : ERJA1 type)

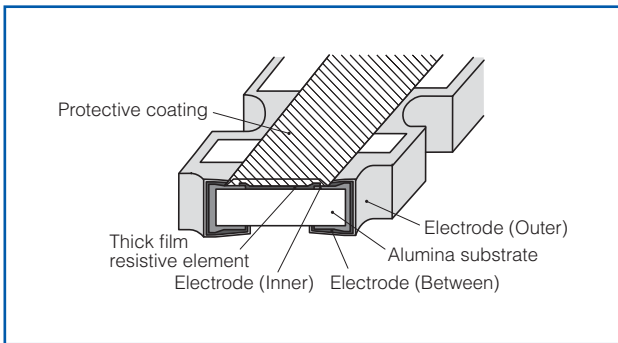

Power Derating Curve

For resistors operated in ambient temperatures above 70 °C, power rating shall be derated in accordance with the figure below.

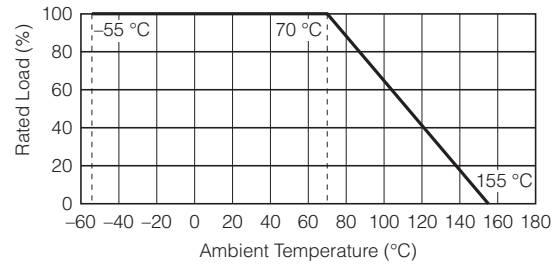

Dimensions in mm (not to scale)

ERJA1 type

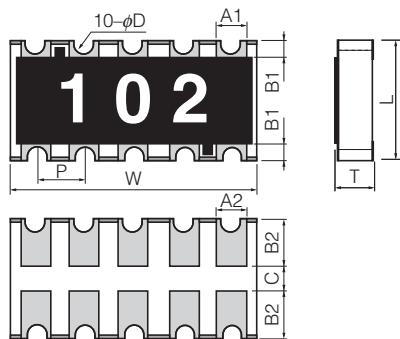

Mass (Weight) [1000 pcs.] : 40 g

Dimensions (mm)	L	W	T	A ₁	B ₁
	3.20±0.20	6.40±0.20	0.55±0.10	0.70±0.20	0.45±0.20
Dimensions (mm)	A ₂	B ₂	P	ϕD	C
	0.70±0.20	1.25±0.15	1.27±0.10	0.30 ^{+0.10} _{-0.20}	0.4 min.

ERJB2 type

(R < 10 mΩ)

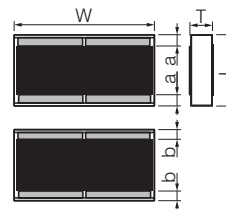

(10 mΩ ≤ R ≤ 1 MΩ)

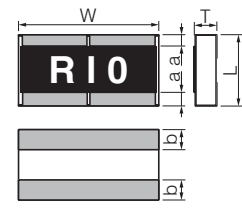

Mass (Weight) [1000 pcs.] : 11 g

Dimensions (mm)	L	W	T	a	b
5 mΩ ≤ R < 10 mΩ	1.60±0.15	3.20±0.20	0.65±0.15	0.30±0.20	0.30±0.20
10 mΩ ≤ R < 220 mΩ			0.55±0.15	0.25±0.20	0.50±0.20
220 mΩ ≤ R ≤ 1 MΩ				0.25±0.20	

ERJB1 type

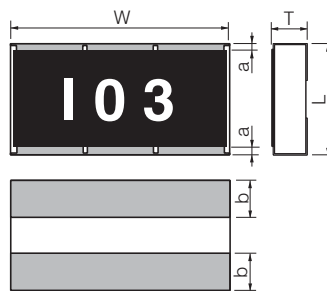

Mass (Weight) [1000 pcs.] : 27 g

Dimensions (mm)	L	W	T	a	b
	2.50±0.20	5.00±0.20	0.55±0.20	0.25±0.20	0.90±0.20

ERJB3 type

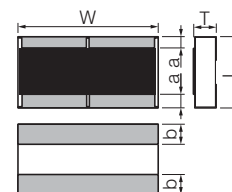

Mass (Weight) [1000 pcs.] : 4.8 g

Dimensions (mm)	L	W	T	a	b
	1.25±0.10	2.00±0.15	0.50±0.10	0.25±0.20	0.40±0.20

Circuit Configuration

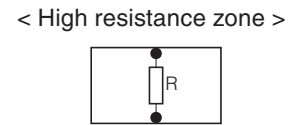
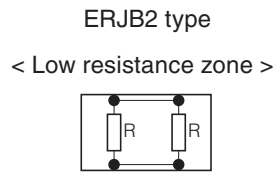
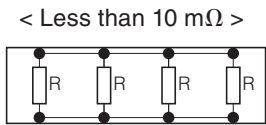
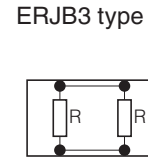
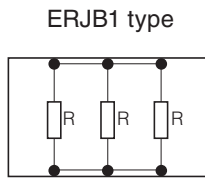
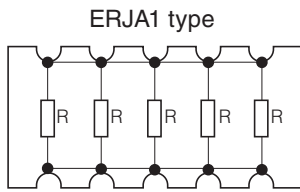

Anti-Surge Thick Film Chip Resistors

Type: **ERJ P03, PA3, P06, P08, P14**



Features

- ESD surge characteristics superior to standard metal film resistors
- High reliability
Metal glaze thick film resistive element and three layers of electrodes
- Suitable for both reflow and flow soldering
- High power ... 0.20 W : 0603 inch / 1608 mm size (ERJP03)
0.25 W : 0603 inch / 1608 mm size (ERJPA3)
0.50 W : 0805 inch / 2012 mm size (ERJP06), 1210 inch / 3225 mm size (ERJP14)
0.66 W : 1206 inch / 3216 mm size (ERJP08)
- Reference Standards... IEC 60115-8, JIS C 5201-8, EIAJ RC-2134B
- AEC-Q200 qualified
- RoHS compliant

As for Packaging Methods, Land Pattern, Soldering Conditions and Safety Precautions,
Please see Data Files

Explanation of Part Numbers

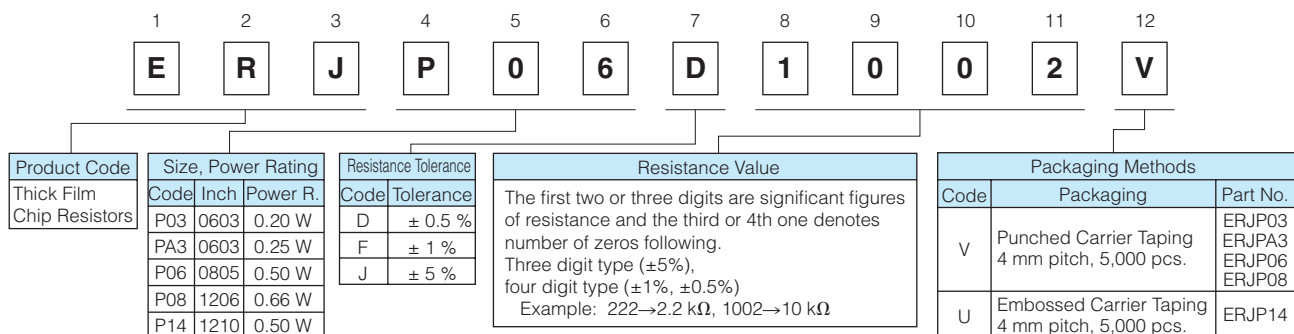

Construction

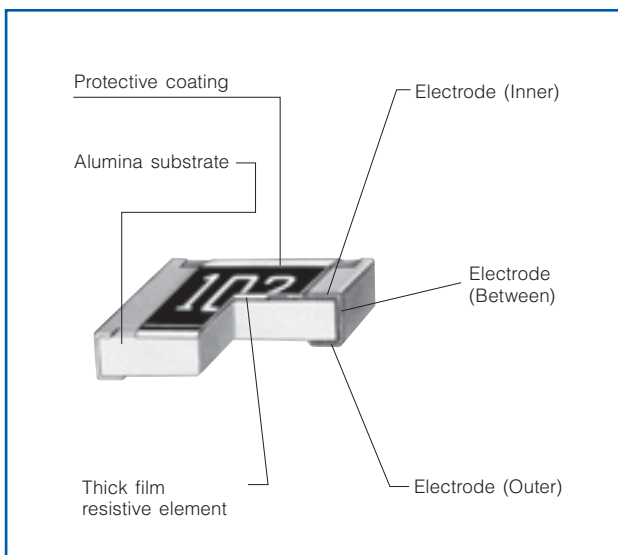

Dimensions in mm (not to scale)

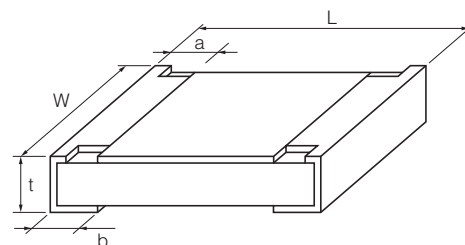

Part No. (inch size)	Dimensions (mm)					Mass (Weight) [g/1000 pcs.]
	L	W	a	b	t	
ERJP03 (0603)	1.60 ^{+0.15}	0.80 ^{+0.15} _{-0.05}	0.15 ^{+0.15} _{-0.10}	0.30 ^{+0.15}	0.45 ^{+0.10}	2
ERJPA3 (0603)	1.60 ^{+0.15}	0.80 ^{+0.15} _{-0.05}	0.15 ^{+0.15} _{-0.10}	0.25 ^{+0.10}	0.45 ^{+0.10}	2
ERJP06 (0805)	2.00 ^{+0.20}	1.25 ^{+0.10}	0.25 ^{+0.20}	0.40 ^{+0.20}	0.60 ^{+0.10}	4
ERJP08 (1206)	3.20 ^{+0.05} _{-0.20}	1.60 ^{+0.05} _{-0.15}	0.40 ^{+0.20}	0.50 ^{+0.20}	0.60 ^{+0.10}	10
ERJP14 (1210)	3.20 ^{+0.20}	2.50 ^{+0.20}	0.35 ^{+0.20}	0.50 ^{+0.20}	0.60 ^{+0.10}	16

Ratings

Part No. (inch size)	Power Rating ⁽³⁾ at 70 °C (W)	Limiting Element Voltage ⁽¹⁾ (V)	Maximum Overload Voltage ⁽²⁾ (V)	Resistance Tolerance (%)	Resistance Range (Ω)	T.C.R. ($\times 10^{-6}/^{\circ}\text{C}$)	Category Temperature Range (°C)
ERJP03 (0603)	0.20	150	200	±0.5	10 to 1M (E24, E96)	±150	-55 to +155
				±1	10 to 1M (E24, E96)	±200	
				±5	1 to 1M (E24)	R < 10 Ω : -150 to +400 10 Ω ≤ R : ±200	
ERJPA3 (0603)	0.25	150	200	±0.5, ±1	10 to 1M (E24, E96)	±100	-55 to +155
				±5	1 to 1.5M (E24)	±200	
ERJP06 (0805)	0.50	400	600	±0.5, ±1	10 to 1M (E24, E96)	R < 33 Ω : ±300 33 Ω ≤ R : ±100	-55 to +155
				±5	1 to 3.3M (E24)	R < 10 Ω : -100 to +600 10 Ω ≤ R < 33 Ω : ±300 33 Ω ≤ R : ±200	
ERJP08 (1206)	0.66	500	1000	±0.5, ±1	10 to 1M (E24, E96)	±100	-55 to +155
				±5	1 to 10M (E24)	R < 10 Ω : -100 to +600 10 Ω ≤ R : ±200	
ERJP14 (1210)	0.50	200	400	±0.5, ±1	10 to 1M (E24, E96)	±100	-55 to +155
				±5	1 to 1M (E24)	R < 10 Ω : -100 to +600 10 Ω ≤ R : ±200	

(1) Rated Continuous Working Voltage (RCWV) shall be determined from $\text{RCWV} = \sqrt{\text{Power Rating} \times \text{Resistance Values}}$, or Limiting Element Voltage listed above, whichever less.

(2) Overload (Short-time Overload) Test Voltage (SOTV) shall be determined from $\text{SOTV} = 2.5 \times \text{Power Rating}$ or max. Overload Voltage listed above whichever less.

(3) Use it on the condition that the case temperature is below 155 °C.

Power Derating Curve

For resistors operated in ambient temperatures above 70 °C, power rating shall be derated in accordance with the figure on the right.

* When the temperature of ERJP14 is 155 °C or less, the derating start temperature can be changed to 125 °C. (See the dotted line)

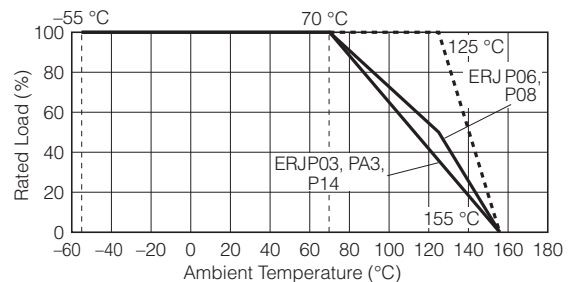

ESD Characteristic

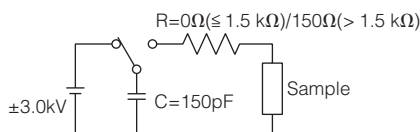

— Anti-Surge Thick Film Chip Resistors (ERJP Type)
 - - - Thick Film Chip Resistors (ERJ Type)

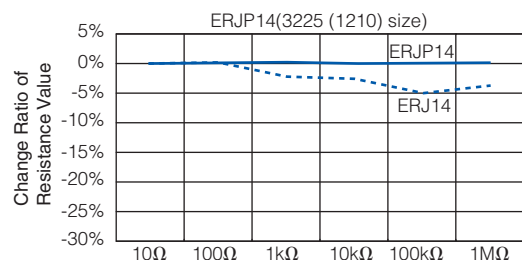
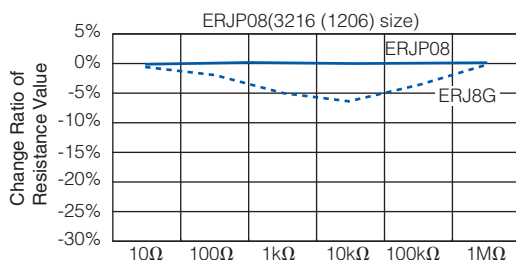
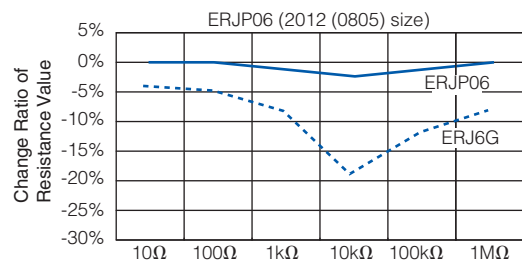
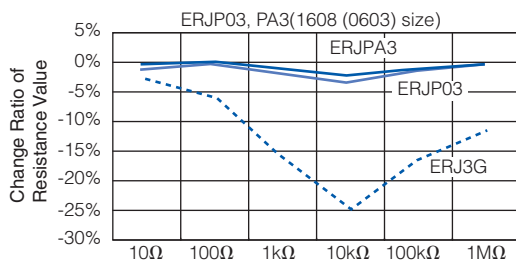

Anti-Pulse Thick Film Chip Resistors



Type: **ERJ T06, T08, T14**

Features

- Anti-Pulse characteristics
High pulse characteristics achieved by the optimized trimming specifications
- High reliability
Metal glaze thick film resistive element and three layers of electrodes
- Suitable for both reflow and flow soldering
- High power ... 0.25W : 0805 inch / 2012 mm size (ERJT06)
0.33W : 1206 inch / 3216 mm size (ERJT08)
0.50W : 1210 inch / 3225 mm size (ERJT14)
- Reference Standards ... IEC 60115-8, JIS C 5201-8, EIAJ RC-2134B
- AEC-Q200 qualified
- RoHS compliant

As for Packaging Methods, Land Pattern, Soldering Conditions and Safety Precautions,

Please see Data Files

Explanation of Part Numbers

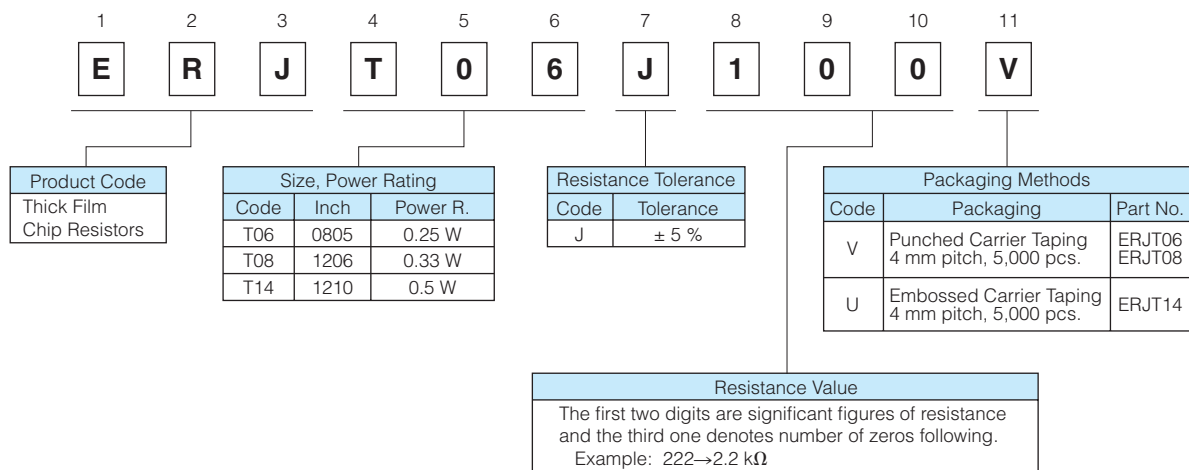

Construction

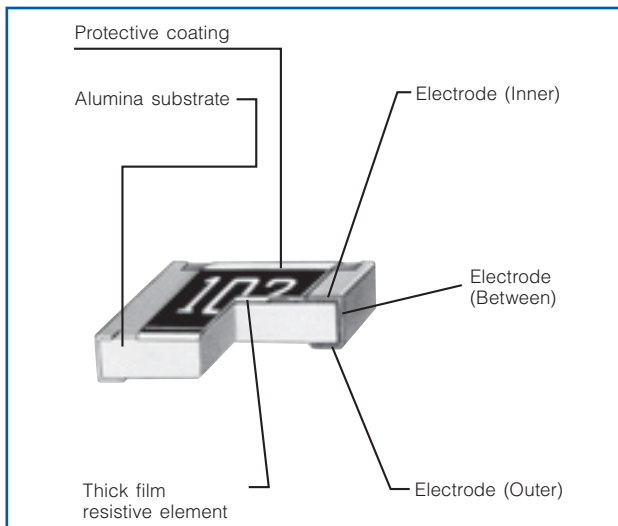

Dimensions in mm (not to scale)

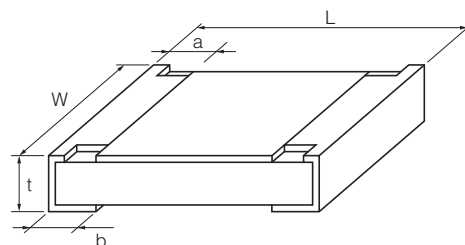

Part No. (inch size)	Dimensions (mm)					Mass (Weight) [g/1000 pcs.]
	L	W	a	b	t	
ERJT06 (0805)	2.00 ^{+0.20}	1.25 ^{+0.10}	0.25 ^{+0.20}	0.40 ^{+0.20}	0.60 ^{+0.10}	4
ERJT08 (1206)	3.20 ^{+0.05} _{-0.20}	1.60 ^{+0.05} _{-0.15}	0.40 ^{+0.20}	0.50 ^{+0.20}	0.60 ^{+0.10}	10
ERJT14 (1210)	3.20 ^{+0.20}	2.50 ^{+0.20}	0.35 ^{+0.20}	0.50 ^{+0.20}	0.60 ^{+0.10}	16

Ratings

Part No. (inch size)	Power Rating at 70 °C (W)	Limiting Element Voltage ⁽¹⁾ (V)	Maximum Overload Voltage ⁽²⁾ (V)	Resistance Tolerance (%)	Resistance Range (Ω)	T.C.R. ($\times 10^{-6}/^{\circ}\text{C}$)	Category Temperature Range (°C)
ERJT06 (0805)	0.25	150	200	±5	1 to 1 M (E24)	Less than 10 Ω : -100 to +600 Less than 33 Ω : ±300 More than 33 Ω : ±200	-55 to +155
ERJT08 (1206)	0.33	200	400	±5	1 to 1 M (E24)	Less than 10 Ω : -100 to +600 More than 10 Ω : ±200	-55 to +155
ERJT14 (1210)	0.50	200	400	±5	1 to 1 M (E24)	Less than 10 Ω : -100 to +600 More than 10 Ω : ±200	-55 to +155

(1) Rated Continuous Working Voltage (RCWV) shall be determined from $\text{RCWV} = \sqrt{\text{Power Rating} \times \text{Resistance Values}}$, or Limiting Element Voltage listed above, whichever less.

(2) Overload (Short-time Overload) Test Voltage (SOTV) shall be determined from $\text{SOTV} = 2.5 \times \text{Power Rating}$ or max. Overload Voltage listed above whichever less.

Power Derating Curve

For resistors operated in ambient temperatures above 70 °C, power rating shall be derated in accordance with the figure on the right.

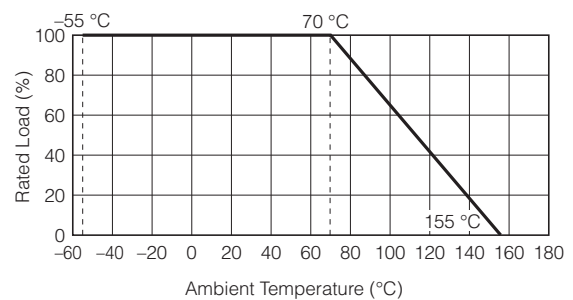

Limiting Power Curve

- In rush pulse Characteristic

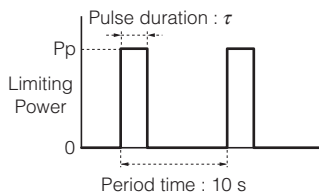

Test cycle : 1000 cycles
Spec : Resistance value = within ±5%

- : Anti-Pulse Thick Film Chip Resistors (ERJT Type)
- : Thick Film Chip Resistors (ERJ Type)

- ERJT06 (0805 inch/2012 mm size)

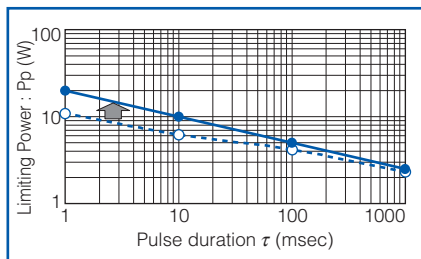

- ERJT08 (1206 inch/3216 mm size)

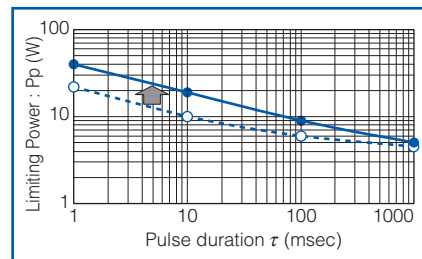

- ERJT14 (1210 inch/3225 mm size)

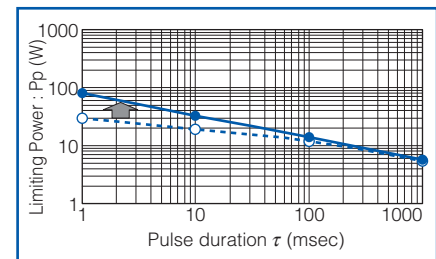

Anti-Sulfurated Thick Film Chip Resistors



Type: **ERJ S02, S03, S06, S08, S14, S12, S1D, S1T**
(Au-based inner electrode type)

Type: **ERJ S6S, S6Q**

Type: **ERJ U01, U02, U03, U06, U08, U14, U12, U1D, U1T**
(Ag-Pd-based inner electrode type)

Features

- High resistance to sulfurization achieved by adopting an Au-based inner electrode (ERJS0/S1 type) and Ag-Pd-based inner electrode (ERJS6, ERJU type)
- High reliability
Metal glaze thick film resistive element and three layers of electrodes
- Suitable for both reflow and flow soldering
- Low Resistance type...ERJS6S, S6Q : 0.1 Ω to 1.0 Ω
- Reference Standard...IEC 60115-8, JIS C 5201-8, EIAJ RC-2134B
- AEC-Q200 qualified (Exemption ERJU01)
- RoHS compliant

■ **As for Packaging Methods, Land Pattern, Soldering Conditions and Safety Precautions,**
Please see Data Files

Explanation of Part Numbers

- ERJS0, S1, U0, U1 Type

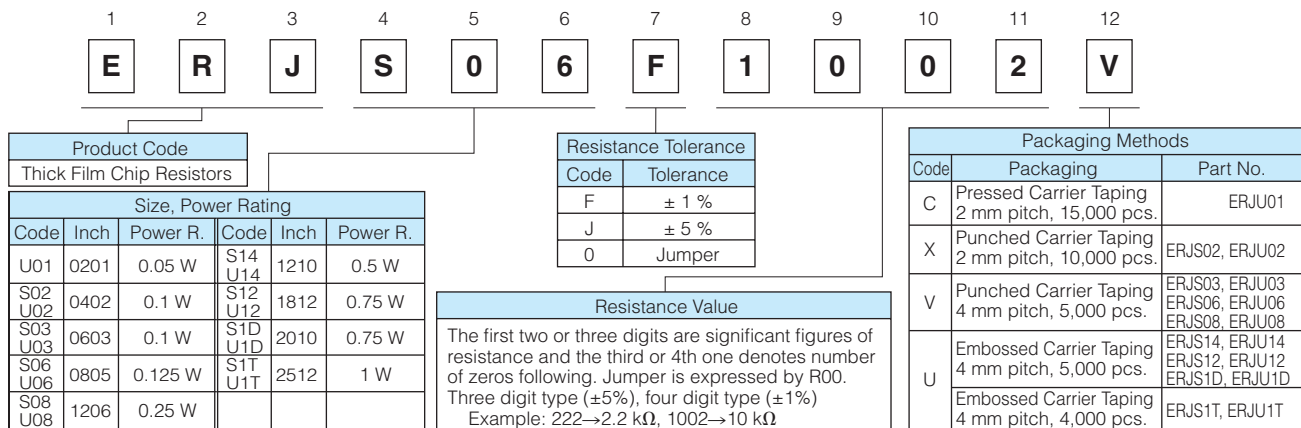

- ERJS6S, S6Q Type

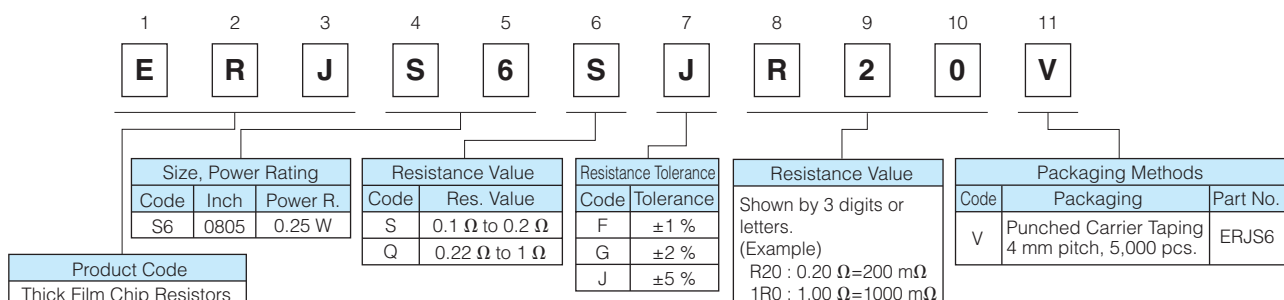

Construction

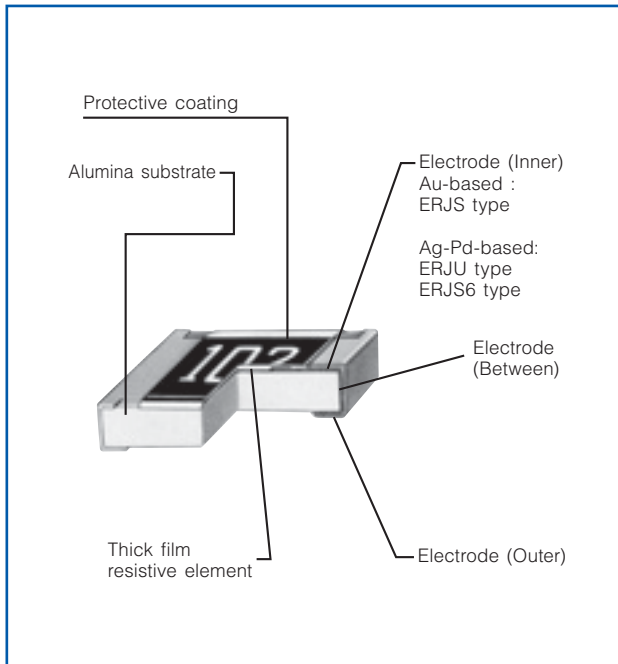

Dimensions in mm (not to scale)

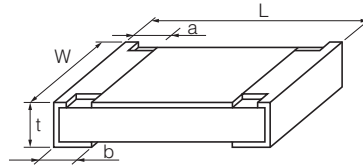

Part No. (inch size)	Dimensions (mm)					Mass (Weight) [g/1000 pcs.]
	L	W	a	b	t	
ERJU01 (0201)	0.60 ^{+0.03}	0.30 ^{+0.03}	0.10 ^{+0.05}	0.15 ^{+0.05}	0.23 ^{+0.03}	0.15
ERJS02 ERJU02	1.00 ^{+0.05}	0.50 ^{+0.05}	0.20 ^{+0.10}	0.25 ^{+0.10}	0.35 ^{+0.05}	0.8
ERJS03 ERJU03	1.60 ^{+0.15}	0.80 ^{+0.15}	0.30 ^{+0.20}	0.30 ^{+0.15}	0.45 ^{+0.10}	2
ERJS06 ERJU06	2.00 ^{+0.20}	1.25 ^{+0.10}	0.40 ^{+0.20}	0.40 ^{+0.20}	0.60 ^{+0.10}	4
ERJS6□ (0805)	2.00 ^{+0.20}	1.25 ^{+0.10}	0.45 ^{+0.20}	0.45 ^{+0.20}	0.55 ^{+0.10}	6
ERJS08 ERJU08	3.20 ^{+0.05} -0.20	1.60 ^{+0.05} -0.15	0.50 ^{+0.20}	0.50 ^{+0.20}	0.60 ^{+0.10}	10
ERJS14 ERJU14	3.20 ^{+0.20}	2.50 ^{+0.20}	0.50 ^{+0.20}	0.50 ^{+0.20}	0.60 ^{+0.10}	16
ERJS12 ERJU12	4.50 ^{+0.20}	3.20 ^{+0.20}	0.50 ^{+0.20}	0.50 ^{+0.20}	0.60 ^{+0.10}	27
ERJS1D ERJU1D	5.00 ^{+0.20}	2.50 ^{+0.20}	0.60 ^{+0.20}	0.60 ^{+0.20}	0.60 ^{+0.10}	27
ERJS1T ERJU1T	6.40 ^{+0.20}	3.20 ^{+0.20}	0.65 ^{+0.20}	0.60 ^{+0.20}	0.60 ^{+0.10}	45

Ratings

Part No. (inch size)	Power Rating at 70 °C (W)	Limiting Element Voltage ⁽¹⁾ (V)	Maximum Overload Voltage ⁽²⁾ (V)	Resistance Tolerance (%)	Resistance Range (Ω)	T.C.R. (×10 ⁻⁶ /°C)	Category Temperature Range (°C)
ERJU01 (0201)	0.05	25	50	±1 ±5	10 to 1 M (E24, E96) 1 to 1 M (E24)	<10 Ω: -100 to +600 10 Ω to 1 MΩ: ±200(±5%) ±100(±1%)* *ERJU01, ERJS02, ERJU02 : ±200 1 MΩ<: -400 to +150	-55 to +125
ERJS02 ERJU02 (0402)	0.1	50	100	±1 ±5	10 to 1 M (E24, E96) 1 to 3.3 M (E24)		-55 to +155
ERJS03 ERJU03 (0603)	0.1	75	150	±1 ±5	10 to 1 M (E24, E96) 1 to 10 M (E24)		-55 to +155
ERJS06 ERJU06 (0805)	0.125	150	200	±1 ±5	10 to 1 M (E24, E96) 1 to 10 M (E24)		-55 to +155
ERJS08 ERJU08 (1206)	0.25	200	400	±1 ±5	10 to 1 M (E24, E96) 1 to 10 M (E24)		-55 to +155
ERJS14 ERJU14 (1210)	0.5	200	400	±1 ±5	10 to 1 M (E24, E96) 1 to 10 M (E24)		-55 to +155
ERJS12 ERJU12 (1812)	0.75	200	500	±1 ±5	10 to 1 M (E24, E96) 1 to 10 M (E24)		-55 to +155
ERJS1D ERJU1D (2010)	0.75	200	500	±1 ±5	10 to 1 M (E24, E96) 1 to 10 M (E24)		-55 to +155
ERJS1T ERJU1T (2512)	1.0	200	500	±1 ±5	10 to 1 M (E24, E96) 1 to 10 M (E24)		-55 to +155

(1) Rated Continuous Working Voltage (RCWV) shall be determined from $RCWV = \sqrt{\text{Power Rating} \times \text{Resistance Values}}$, or Limiting Element Voltage listed above, whichever less.

(2) Overload (Short-time Overload) Test Voltage (SOTV) shall be determined from $SOTV = 2.5 \times \text{Power Rating}$ or max. Overload Voltage listed above whichever less.

[Low Resistance type]

Part No. (inch size)	Power Rating at 70 °C (W)	Resistance Tolerance (%)	Resistance Range (Ω)	T.C.R. (×10 ⁻⁶ /°C)	Category Temperature Range (°C)
ERJS6S (0805)	0.25	±1, ±2, ±5	0.1 to 0.2 (E24)	±150	-55 to +155
ERJS6Q (0805)			0.22 to 1 (E24)		

[For Jumper]

Part No. (inch size)	Rated Current (A)	Maximum Overload Current (A)
ERJU01 (0201)	0.5	1
ERJS02 ERJU02 (0402)	1	2
ERJS03 ERJU03 (0603)		
ERJS06 ERJU06 ERJS6S/Q (0805)	2	4
ERJS08 ERJU08 (1206)		
ERJS14 ERJU14 (1210)		
ERJS12 ERJU12 (1812)		
ERJS1D ERJU1D (2012)		
ERJS1T ERJU1T (2512)		

Power Derating Curve

For resistors operated in ambient temperatures above 70 °C, power rating shall be derated in accordance with the figure below.

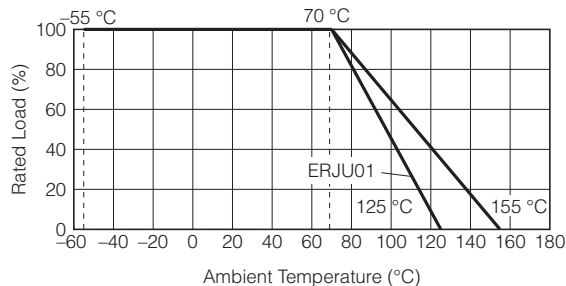

Anti-Sulfurated High Power Chip Resistors / Wide Terminal Type



Type: **ERJ C1**

Features

- High resistance to sulfurization achieved by adopting Anti-Sulfurated electrode structure and material
- High solder-joint reliability by wide terminal construction
- Excellent heat dissipation characteristics by wide terminal construction
- AEC-Q200 qualified
- RoHS compliant

Recommended Applications

- Motor control circuit of the industrial equipment
- Automotive electronic circuits including ECUs (Electrical control unit), anti-lock braking systems and air-bag systems
- Current sensing for power supply circuits in a variety of equipment

■ **As for Packaging Methods, Land Pattern, Soldering Conditions and Safety Precautions,**
Please see Data Files

Explanation of Part Numbers

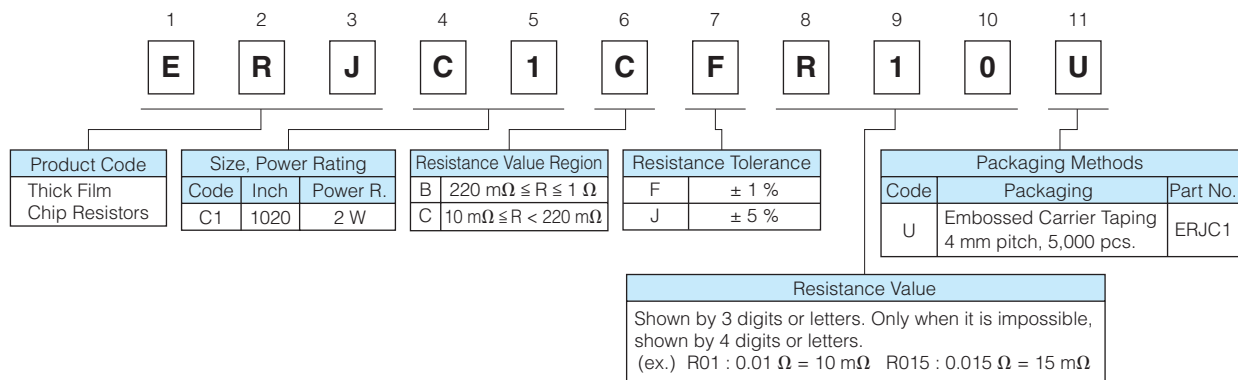

Construction

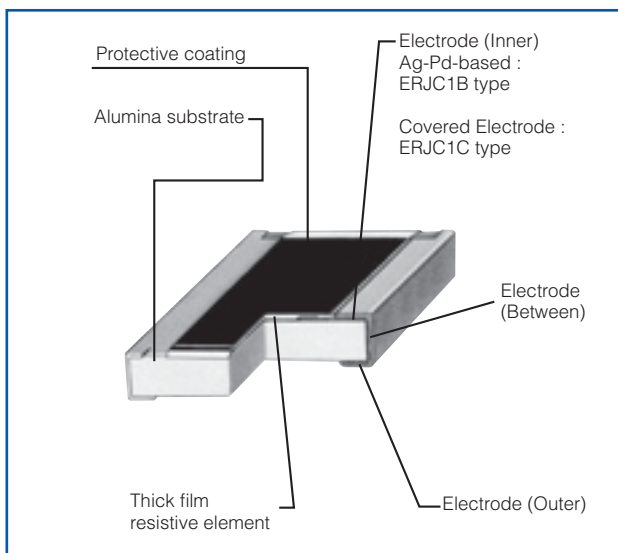

Dimensions in mm (not to scale)

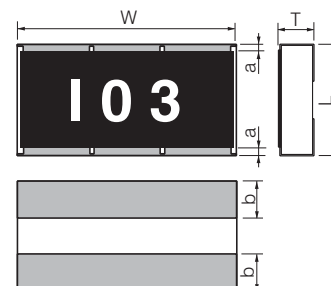

Part No. (inch size)	Dimensions (mm)					Mass (Weight) [g/1000 pcs.]
	L	W	T	a	b	
ERJC1B (1020)	2.50±0.20	5.00±0.20	0.55±0.20	0.35±0.20	0.90±0.20	27
ERJC1C (1020)				0.60±0.20		

Circuit Configuration

Type ERJC1

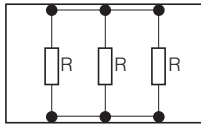

Ratings

Part No. (inch size)	Power Rating at 70 °C ⁽¹⁾ (W)	Resistance Tolerance (%)	Resistance Range (Ω)	T.C.R. (×10 ⁻⁶ /°C)	Category Temperature Range (°C)
ERJC1 (1020)	2	±1	10 m to 1 (E24)	10 mΩ ≤ R < 22 mΩ : ±350 22 mΩ ≤ R < 47 mΩ : ±200 47 mΩ ≤ R < 100 mΩ : ±150 100 mΩ ≤ R ≤ 1 Ω : ±100	-55 to +155
		±5		10 mΩ ≤ R < 22 mΩ : ±350 22 mΩ ≤ R < 1 Ω : ±200	

(1) Use it on the condition that the case temperature is below 155 °C.

Power Derating Curve

For resistors operated in ambient temperatures above 70 °C, power rating shall be derated in accordance with the figure on the right.

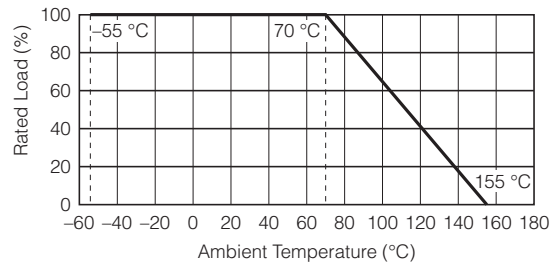

Chip Resistor Array

Type: **EXB 14V, 18V, 24V, 28V, N8V, 2HV, 34V, V4V, 38V, V8V, S8V**

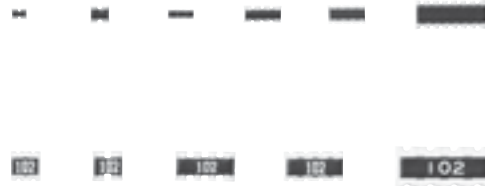

Features

- High density
 2 resistors in 0.8 mm × 0.6 mm size / 0302 inch size : EXB14V
 4 resistors in 1.4 mm × 0.6 mm size / 0502 inch size : EXB18V
 2 resistors in 1.0 mm × 1.0 mm size / 0404 inch size : EXB24V
 4 resistors in 2.0 mm × 1.0 mm size / 0804 inch size : EXB28V, EXBN8V
 8 resistors in 3.8 mm × 1.6 mm size / 1506 inch size : EXB2HV
 2 resistors in 1.6 mm × 1.6 mm size / 0606 inch size : EXB34V, EXBV4V
 4 resistors in 3.2 mm × 1.6 mm size / 1206 inch size : EXB38V, EXBV8V
 4 resistors in 5.1 mm × 2.2 mm size / 2009 inch size : EXBS8V
- Improvement of placement efficiency
 Placement efficiency of Chip Resistor Array is two, four or eight times of the flat type chip resistor
- Reference Standard...IEC 60115-9, JIS C 5201-9, EIAJ RC-2129
- AEC-Q200 qualified (EXB2, EXB3)
- RoHS compliant

As for Packaging Methods, Land Pattern, Soldering Conditions and Safety Precautions,
 Please see Data Files

Explanation of Part Numbers

1	2	3	4	5	6	7	8	9	10	11
E	X	B	V	8	V	4	7	2	J	V

Product Code	Size and construction		No. of Terminal	Schematics	Resistance Value	Resistance Tolerance	Packaging Methods	
Thick Film Chip Resistor Networks	Code	Inch	Terminal type				Code	Part No.
	1	0201 Array	Convex/Flat Terminal	4 4 Terminal	The first two digits are significant figures of resistance value and the third one denotes the number of zeros following. Jumper is expressed by R00 Example : 222 → 2.2 kΩ	J ±5 % 0 Jumper	Nil	EXBS8V
	2	0402 Array	Convex Terminal	8 8 Terminal			X	EXB14V, 18V, 24V, 28V, N8V
	3	0603 Array	Convex Terminal	H 16 Terminal			V	EXB2HV, 34V, 38V, V4V, V8V
	N	0402 Array	Concave Terminal					
	V	0603 Array	Concave Terminal					
	S	0805 Array	Flat Terminal					

Construction (Example : Concave Terminal)

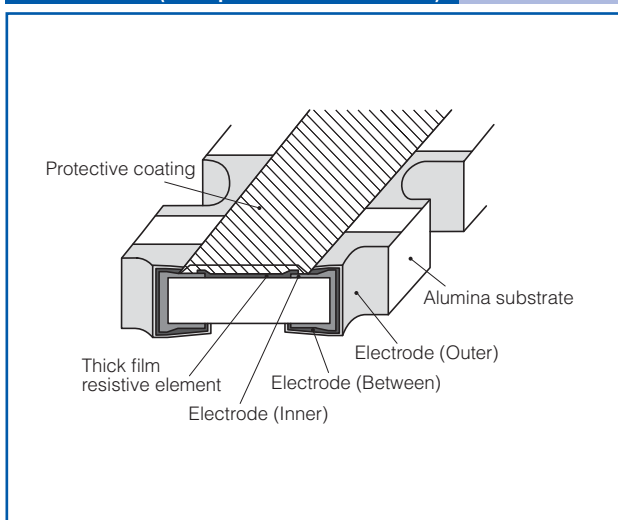

Schematics

- Isolated type

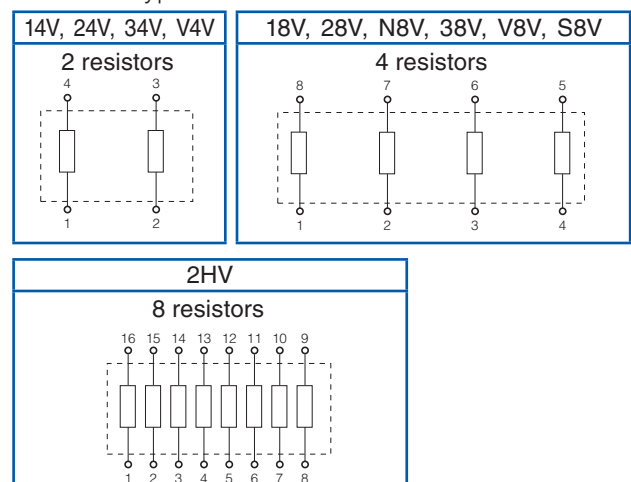

Ratings

Item		Specifications
Resistance Range		10 Ω to 1 MΩ : E24 series
Resistance Tolerance		J : ±5 %
Number of Terminals	14V,24V,V4V,34V	4 terminal
	18V,28V,N8V,38V,V8V,S8V	8 terminal
	2HV	16 terminal
Number of Resistors	14V,24V,V4V,34V	2 element
	18V,28V,N8V,38V,V8V,S8V	4 element
	2HV	8 element
Power Rating at 70 °C	14V,N8V	0.031 W/element
	18V	0.031 W/element (0.1 W/package)
	24V,28V,V4V,34V,V8V,38V	0.063 W/element
	S8V	0.1 W/element
	2HV	0.063 W/element (0.25 W/package)

Item		Specifications	
Limiting Element Voltage ⁽¹⁾	14V,18V	12.5 V	
	2HV	25 V	
	24V,28V,N8V,38V,34V,V4V,V8V	50 V	
	S8V	100 V	
Maximum Overload Voltage ⁽²⁾	14V,18V	25 V	
	2HV	50 V	
	24V,28V,N8V,38V,34V,V4V,V8V	100 V	
	S8V	200 V	
T.C.R.		±200×10 ⁻⁶ /°C	
Category Temperature Range		-55 °C to 125 °C	
Jumper Array	Rated Current	14V,18V	0.5 A
		2HV,24V,28V,N8V,38V,34V,V4V,V8V	1 A
		S8V	2 A
	Maximum Overload Current	14V,18V	1 A
		2HV,24V,28V,N8V,38V,34V,V4V,V8V	2 A
		S8V	4 A

(1) Rated Continuous Working Voltage (RCWV) shall be determined from $RCWV = \sqrt{\text{Power Rating} \times \text{Resistance Value}}$, or Limiting Element Voltage listed above, whichever less.

(2) Overload (Short-time Overload) Test Voltage (SOTV) shall be determined from $SOTV = 2.5 \times \text{Power Rating}$ or max. Overload Voltage listed above whichever less.

Power Derating Curve

For resistors operated in ambient temperatures above 70 °C, power rating shall be derated in accordance with the figure on the right.

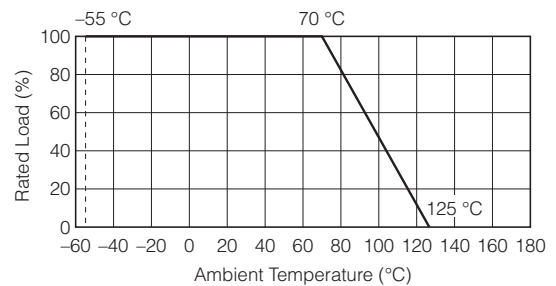

Dimensions in mm (not to scale)

(1) Convex Terminal type

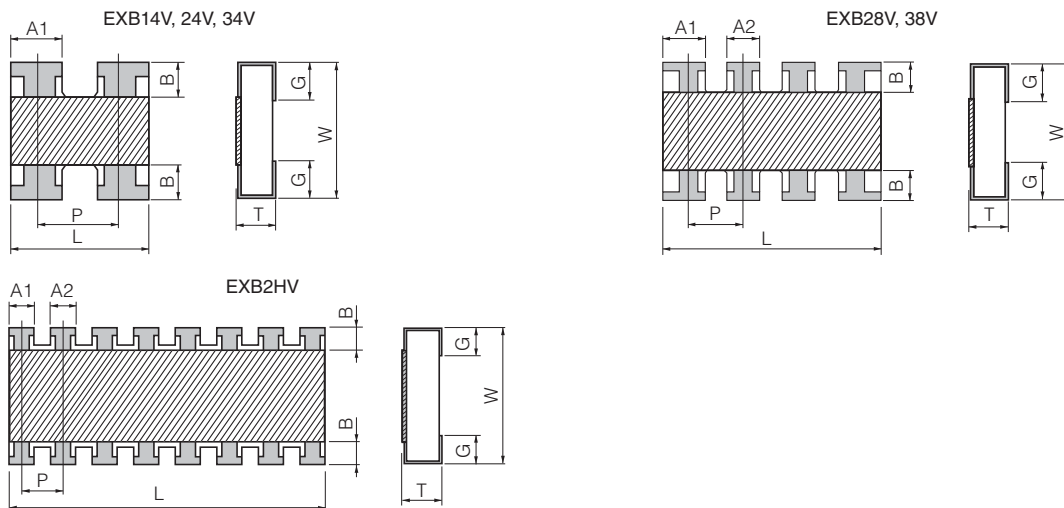

Part No. (inch size)	Dimensions (mm)								Mass (Weight) [g/1000 pcs.]
	L	W	T	A1	A2	B	P	G	
EXB14V (0201×2)	0.80 ^{±0.10}	0.60 ^{±0.10}	0.35 ^{±0.10}	0.35 ^{±0.10}	—	0.15 ^{±0.10}	(0.50)	0.15 ^{±0.10}	0.5
EXB24V (0402×2)	1.00 ^{±0.10}	1.00 ^{±0.10}	0.35 ^{±0.10}	0.40 ^{±0.10}	—	0.18 ^{±0.10}	(0.65)	0.25 ^{±0.10}	1.2
EXB28V (0402×4)	2.00 ^{±0.10}	1.00 ^{±0.10}	0.35 ^{±0.10}	0.45 ^{±0.10}	0.35 ^{±0.10}	0.20 ^{±0.10}	(0.50)	0.25 ^{±0.10}	2.0
EXB2HV (0402×8)	3.80 ^{±0.10}	1.60 ^{±0.10}	0.45 ^{±0.10}	0.35 ^{±0.10}	0.35 ^{±0.10}	0.30 ^{±0.10}	(0.50)	0.30 ^{±0.10}	9.0
EXB34V (0603×2)	1.60 ^{±0.20}	1.60 ^{±0.15}	0.50 ^{±0.10}	0.65 ^{±0.15}	—	0.30 ^{±0.20}	(0.80)	0.30 ^{±0.20}	3.5
EXB38V (0603×4)	3.20 ^{±0.20}	1.60 ^{±0.15}	0.50 ^{±0.10}	0.65 ^{±0.15}	0.45 ^{±0.15}	0.30 ^{±0.20}	(0.80)	0.35 ^{±0.20}	7.0

() Reference

(2) Concave Terminal type

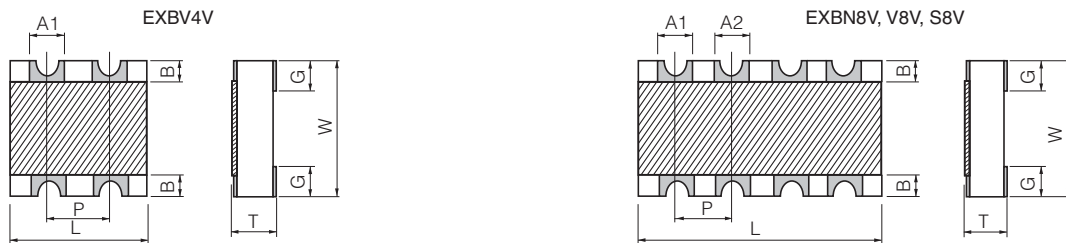

Part No. (inch size)	Dimensions (mm)								Mass (Weight) [g/1000 pcs.]
	L	W	T	A1	A2	B	P	G	
EXBN8V (0402×4)	2.00 ^{±0.10}	1.00 ^{±0.10}	0.45 ^{±0.10}	0.30 ^{±0.10}	0.30 ^{±0.10}	0.20 ^{±0.15}	(0.50)	0.30 ^{±0.15}	3.0
EXBV4V (0603×2)	1.60 ^{+0.20/-0.10}	1.60 ^{+0.20/-0.10}	0.60 ^{±0.10}	0.60 ^{±0.10}	—	0.30 ^{±0.15}	(0.80)	0.45 ^{±0.15}	5.0
EXBV8V (0603×4)	3.20 ^{+0.20/-0.10}	1.60 ^{+0.20/-0.10}	0.60 ^{±0.10}	0.60 ^{±0.10}	0.60 ^{±0.10}	0.30 ^{±0.15}	(0.80)	0.45 ^{±0.15}	10
EXBS8V (0805×4)	5.08 ^{+0.20/-0.10}	2.20 ^{+0.20/-0.10}	0.70 ^{±0.20}	0.80 ^{±0.15}	0.80 ^{±0.15}	0.50 ^{±0.15}	(1.27)	0.55 ^{±0.15}	30

() Reference

(3) Flat Terminal type

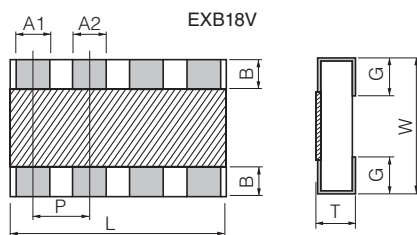

Part No. (inch size)	Dimensions (mm)								Mass (Weight) [g/1000 pcs.]
	L	W	T	A1	A2	B	P	G	
EXB18V (0201×4)	1.40±0.10	0.60±0.10	0.35±0.10	0.20±0.10	0.20±0.10	0.10±0.10	(0.40)	0.20±0.10	1.0

() Reference

Metal Film Chip Resistor Array

Type: **ERA38V**



Features

- High accuracy Small resistance tolerance and Temperature Coefficient of Resistance (T.C.R.)
- High reliability Stable at high temperature and humidity
(85 °C 85 % RH rated load, Category temperature range : -55 to +155 °C)
- High performance Low current noise, excellent non-linearity
- Customize Different resistance values are available. Please contact us for details.
- AEC-Q200 qualified
- RoHS compliant

■ **As for Packaging Methods, Land Pattern, Soldering Conditions and Safety Precautions,**
Please see Data Files

Explanation of Part Numbers

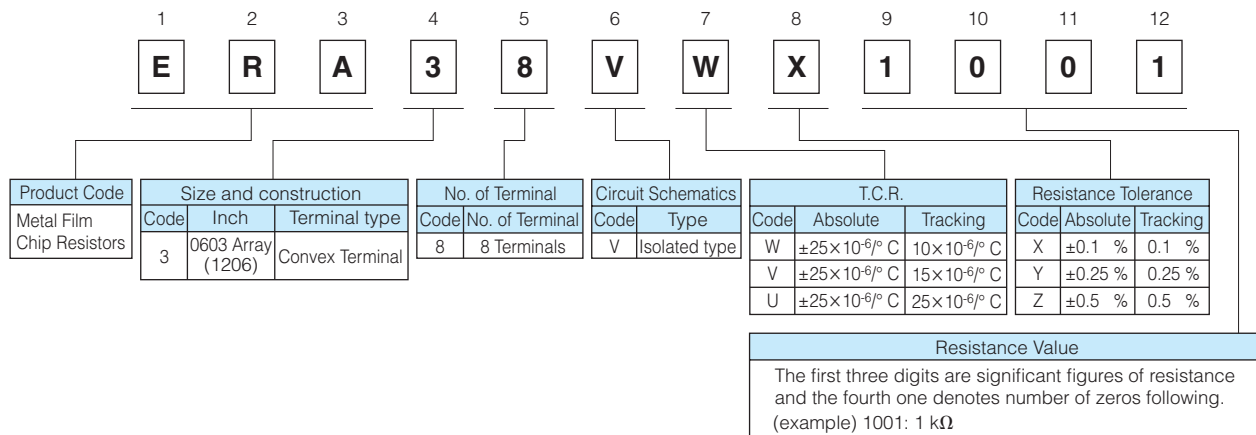

Construction

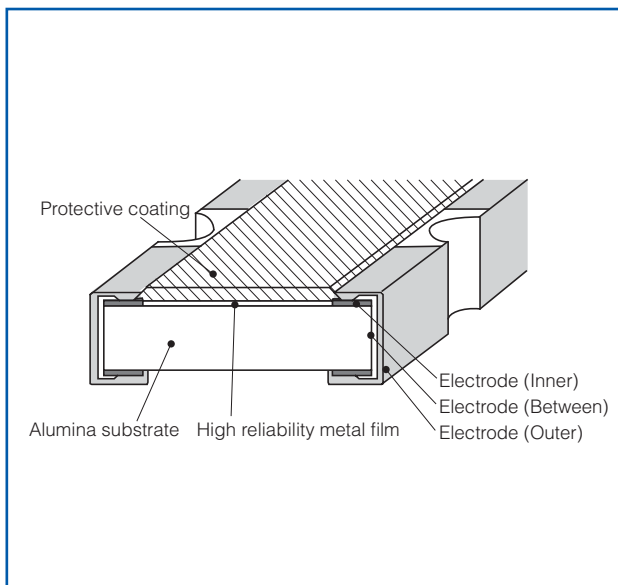

Schematics

- Isolated type

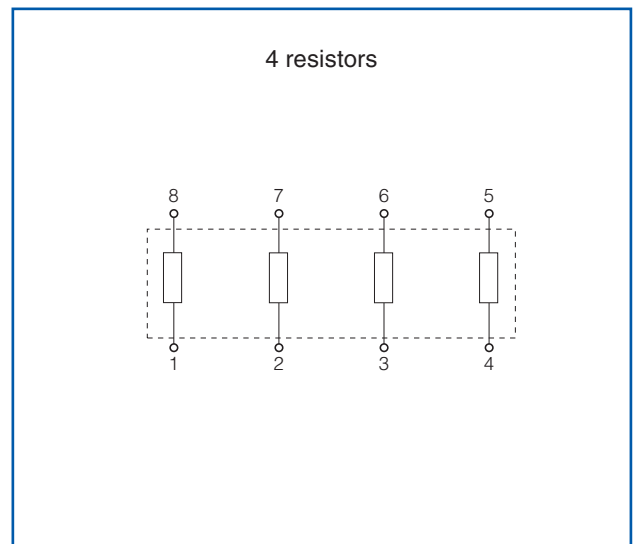

Dimensions in mm (not to scale)

Convex Terminal type

1206 inch size

Dimensions (mm)	L	W	T	A ₁
	3.20±0.20	1.60±0.15	0.50±0.10	0.65±0.15
Dimensions (mm)	A ₂	B	P	G
	0.45±0.15	0.30±0.20	(0.80)	0.35±0.20

Mass (Weight) [g/1000 pcs.] : 7.0 g () Reference

Ratings

Part No. (inch size)	Power Rating at 70 °C (W)	Limiting Element Voltage ⁽¹⁾ (V)	Maximum Overload Voltage ⁽²⁾ (V)	T.C.R. (Absolute) T.C.R. (Tracking) (×10 ⁻⁶ /°C)	Resistance Tolerance (Absolute) Resistance Tolerance (Relative) (%)	Resistance Range ⁽³⁾ (Ω)	Category Temperature Range (°C)
ERA38V (0603×4)	0.063/element	75	150	Absolute : ±25 Tracking : 25 (U)	Absolute : ±0.5 Relative : 0.5 (Z)	100 to 39 k (E24)	-55 to +155
				Absolute : ±25 Tracking : 15 (V)	Absolute : ±0.25 Relative : 0.25 (Y)	1k to 39 k (E24)	
				Absolute : ±25 Tracking : 10 (W)	Absolute : ±0.1 Relative : 0.1 (X)		

(1) Rated Continuous Working Voltage (RCWV) shall be determined from $RCWV = \sqrt{\text{Power Rating} \times \text{Resistance Value}}$, or Limiting Element Voltage listed above, whichever less.

(2) Overload (Short-time Overload) Test Voltage (SOTV) shall be determined from $SOTV = 2.5 \times \text{Power Rating}$ or max. Overload Voltage listed above whichever less.

(3) E96 series resistance values are also available. Please contact us for details.

Power Derating Curve

For resistors operated in ambient temperatures above 85 °C, power rating shall be derated in accordance with the figure on the right.

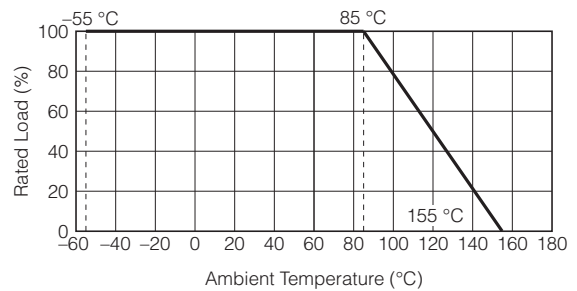

Anti-Sulfurated Chip Resistor Array

Type: **EXB U24, U28, U2H, U34, U38**



Features

- High resistance to sulfurization achieved by adopting an Ag-Pb-based inner electrode
- High density
 - 2 resistors in 1.0 mm × 1.0 mm size / 0404 inch size : EXBU24
 - 4 resistors in 2.0 mm × 1.0 mm size / 0804 inch size : EXBU28
 - 8 resistors in 3.8 mm × 1.6 mm size / 1506 inch size : EXBU2H
 - 2 resistors in 1.6 mm × 1.6 mm size / 0606 inch size : EXBU34
 - 4 resistors in 3.2 mm × 1.6 mm size / 1206 inch size : EXBU38
- Improvement of placement efficiency
 - Placement efficiency of Chip Resistor Array is two, four or eight times of the flat type chip resistor
- Reference Standard...IEC 60115-9, JIS C 5201-9, EIAJ RC-2129
- AEC-Q200 qualified
- RoHS compliant

■ **As for Packaging Methods, Land Pattern, Soldering Conditions and Safety Precautions,**
Please see Data Files

Explanation of Part Numbers

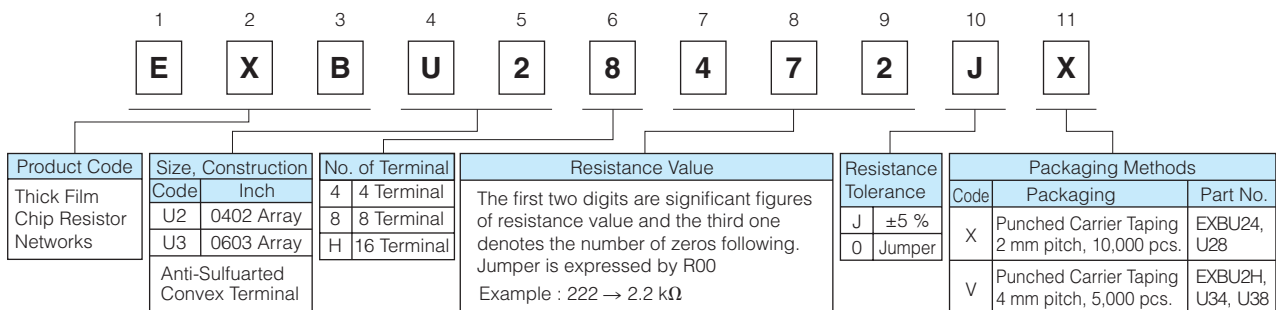

Construction

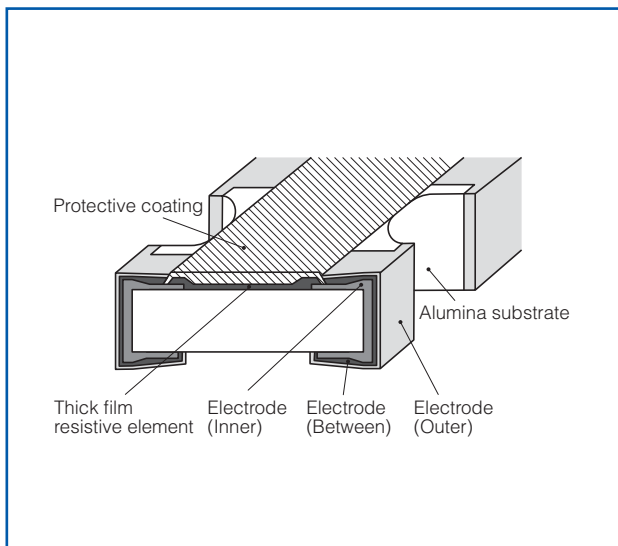

Schematics

- Isolated type

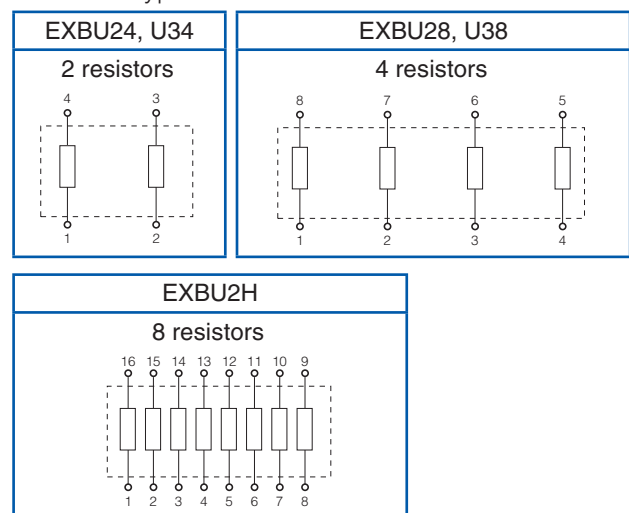

Dimensions in mm (not to scale)

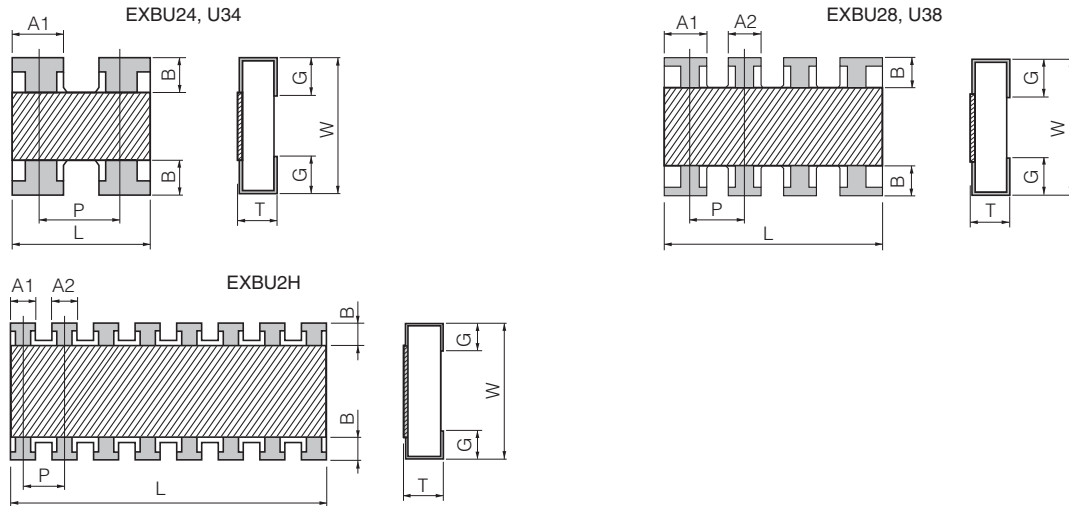

Part No. (inch size)	Dimensions (mm)								Mass (Weight) [g/1000 pcs.]
	L	W	T	A1	A2	B	P	G	
EXBU24 (0402×2)	1.00 ^{±0.10}	1.00 ^{±0.10}	0.35 ^{±0.10}	0.40 ^{±0.10}	—	0.18 ^{±0.10}	(0.65)	0.25 ^{±0.10}	1.2
EXBU28 (0402×4)	2.00 ^{±0.10}	1.00 ^{±0.10}	0.35 ^{±0.10}	0.45 ^{±0.10}	0.35 ^{±0.10}	0.20 ^{±0.10}	(0.50)	0.25 ^{±0.10}	2.0
EXBU2H (0402×8)	3.80 ^{±0.10}	1.60 ^{±0.10}	0.45 ^{±0.10}	0.35 ^{±0.10}	0.35 ^{±0.10}	0.30 ^{±0.10}	(0.50)	0.30 ^{±0.10}	9.0
EXBU34 (0603×2)	1.60 ^{±0.20}	1.60 ^{±0.15}	0.50 ^{±0.10}	0.65 ^{±0.15}	—	0.30 ^{±0.20}	(0.80)	0.30 ^{±0.20}	3.5
EXBU38 (0603×4)	3.20 ^{±0.20}	1.60 ^{±0.15}	0.50 ^{±0.10}	0.65 ^{±0.15}	0.45 ^{±0.15}	0.30 ^{±0.20}	(0.80)	0.35 ^{±0.20}	7.0

() Reference

Ratings

Item	Specifications	
Resistance Range	10 Ω to 1 MΩ E24 series	
Resistance Tolerance	J: ±5 %	
Number of Terminals	U24, U34	4 terminal
	U28, U38	8 terminal
	U2H	16 element
Number of Resistors	U24, U34	2 element
	U28, U38	4 element
	U2H	8 element
Power Rating at 70 °C	U24, U28, U34, U38	0.063 W/element
	U2H	0.063 W/element (0.25 W/package)

Item	Specifications		
Limiting Element Voltage ⁽¹⁾	U2H	25 V	
	U24, U28, U34, U38	50 V	
Max. Overload Voltage ⁽²⁾	U2H	50 V	
	U24, U28, U34, U38	100 V	
T.C.R.	±200×10 ⁻⁶ /°C		
Category Temperature Range	-55 °C to 125 °C		
Jumper Array	Rated Current	U24, U28, U2H, U34, U38	1 A
	Max. Overload Current	U24, U28, U2H, U34, U38	2 A

(1) Rated Continuous Working Voltage (RCWV) shall be determined from $RCWV = \sqrt{\text{Power Rating} \times \text{Resistance Value}}$, or Limiting Element Voltage listed above, whichever less.

(2) Overload (Short-time Overload) Test Voltage (SOTV) shall be determined from $SOTV = 2.5 \times \text{Power Rating}$ or max. Overload Voltage listed above whichever less.

Power Derating Curve

For resistors operated in ambient temperatures above 70 °C, power rating shall be derated in accordance with the figure on the right.

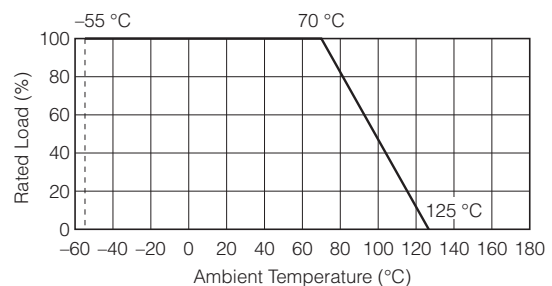

Chip Resistor Networks

Type: **EXBD**
EXBE
EXBA
EXBQ

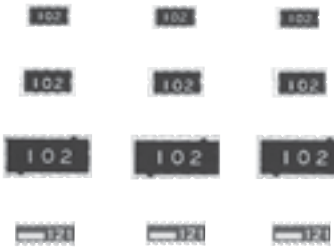

Features

- High density placing for digital signal circuits
 - Bussed 8 or 15 resistors for pull up/down circuits
 - EXBD: 3.2 mm × 1.6 mm × 0.55 mm, 0.635 mm pitch
 - EXBE: 4.0 mm × 2.1 mm × 0.55 mm, 0.8 mm pitch
 - EXBA: 6.4 mm × 3.1 mm × 0.55 mm, 1.27 mm pitch
 - EXBQ: 3.8 mm × 1.6 mm × 0.45 mm, 0.5 mm pitch
 - Available direct placing on the bus line by means of half pitch spacing without through-holes on PWB (“High density placing” is shown below)
- High speed mounting using conventional placing machine
- Reference Standard...IEC 60115-9, JIS C 5201-9, EIAJ RC-2130
- RoHS compliant

[High density placing]

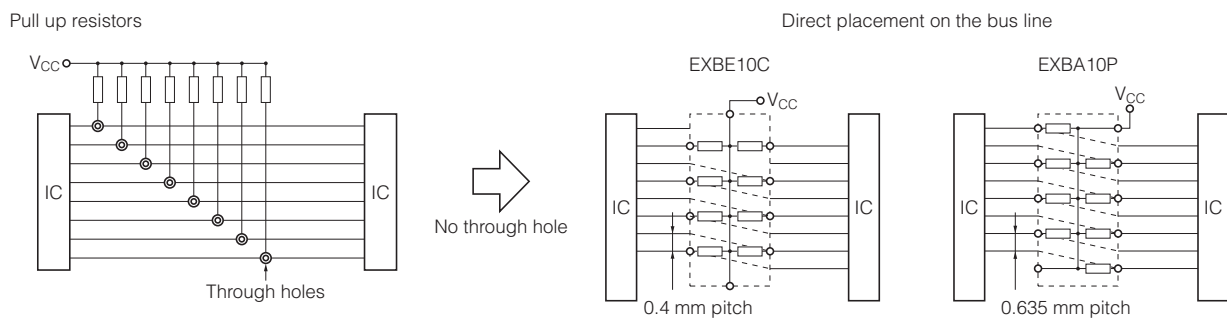

■ **As for Packaging Methods, Land Pattern, Soldering Conditions and Safety Precautions,**
 Please see Data Files

Explanation of Part Numbers

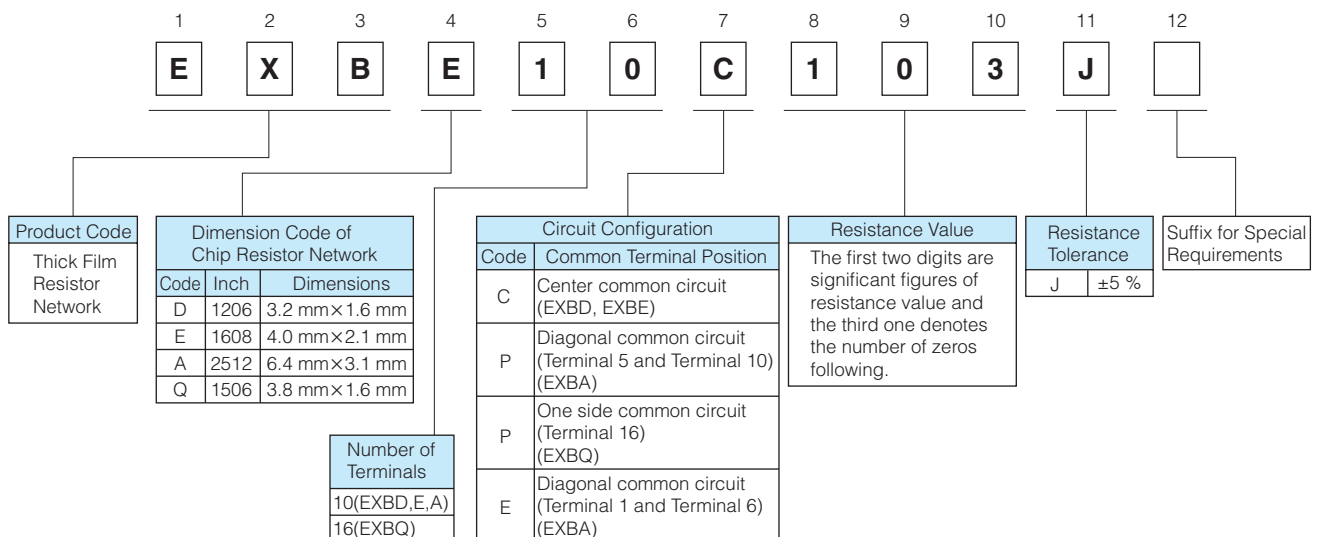

Construction (Example : EXBD)

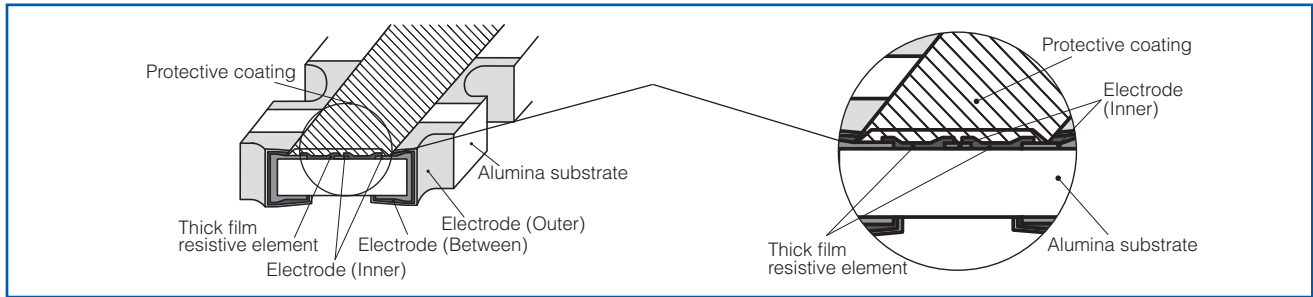

Dimensions in mm (not to scale)

EXBD	EXBE	EXBA	EXBQ
Mass (Weight)[1000 pcs.] : 10 g	Mass (Weight)[1000 pcs.] : 16 g	Mass (Weight)[1000 pcs.] : 40 g	Mass (Weight)[1000 pcs.] : 9 g

Circuit Configuration

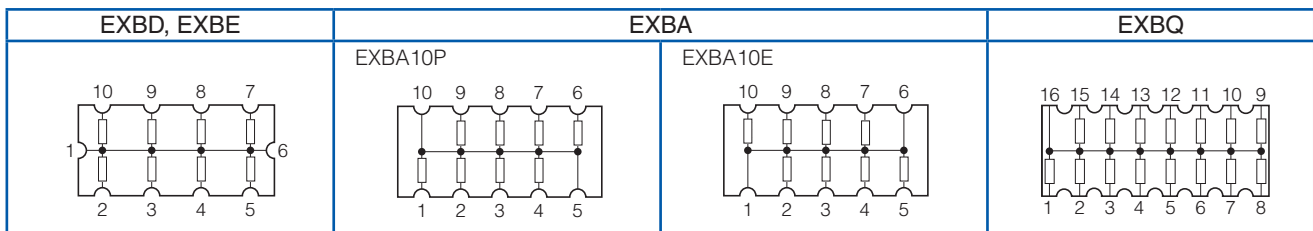

Ratings

Item	Specifications			
	EXBD	EXBE	EXBA	EXBQ
Resistance Range	47 Ω to 1 MΩ (E12)			100 Ω to 470 kΩ (E6 series)
Resistance Tolerance	±5%			
Number of Terminals	10 terminals			16 terminals
Number of Resistors	8 element			15 element
Power Rating at 70 °C	0.05 W/element	0.063 W/element		0.025 W/element
Limiting Element Voltage ⁽¹⁾	25V		50 V	25V
Maximum Overload Voltage ⁽²⁾	50 V		100 V	50 V
T. C. R.	±200 × 10 ⁻⁶ / °C			
Category Temperature Range	-55 °C to +125 °C			

(1) Rated Continuous Working Voltage (RCWV) shall be determined from $RCWV = \sqrt{\text{Power Rating} \times \text{Resistance Value}}$, or Limiting Element Voltage listed above, whichever less.

(2) Overload (Short-time Overload) Test Voltage (SOTV) shall be determined from $SOTV = 2.5 \times RCWV^*$ or Maximum Overload Voltage listed above whichever less.

Power Derating Curve

For resistors operated in ambient temperatures above 70 °C, power rating shall be derated in accordance with the figure on the right.

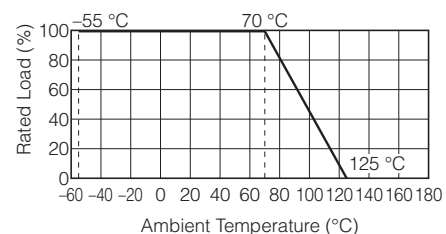

Chip Attenuator

Type: **EXB 14AT**
EXB 24AT



Features

- Unbalanced π type attenuator circuit in one chip
EXB14AT (0.8 mm × 0.6 mm), EXB24AT (1.0 mm × 1.0 mm)
- Reduced mounting area :
EXB14AT : About 60 % smaller than the area of an attenuator circuit consisting of three 0603 chip resistors, almost equal to the area of three 0402 chip resistors
EXB24AT : About 50 % smaller than the area of an attenuator circuit consisting of three 1005 chip resistors, almost equal to the area of three 0603 chip resistors
- Mounting cost reduction : (Only 1 chip placed as compared to 3)
- Attenuation : 1 dB to 10 dB
- RoHS compliant

Recommended Applications

- Attenuation / level control / impedance matching of high frequency
(communication signalling equipment cellular phones(GSM, CDMA, PDC, etc.), PHS, PDAs)

■ **As for Packaging Methods, Land Pattern, Soldering Conditions and Safety Precautions,**
Please see Data Files

Explanation of Part Numbers

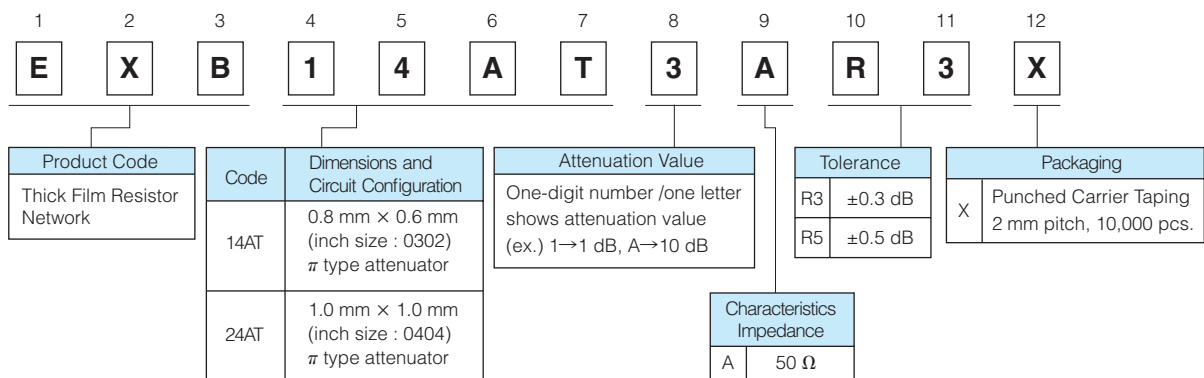

Attenuation-Frequency Characteristics

(EXB14AT, EXB24AT)

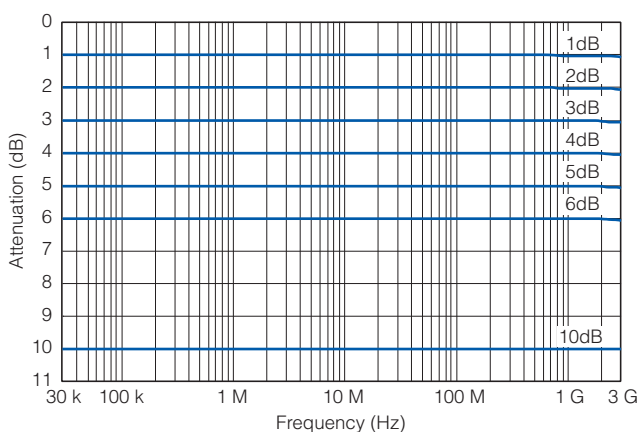

Circuit Configuration

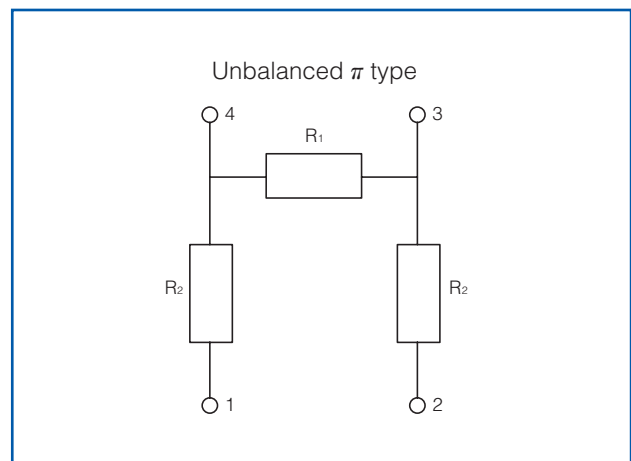

Construction

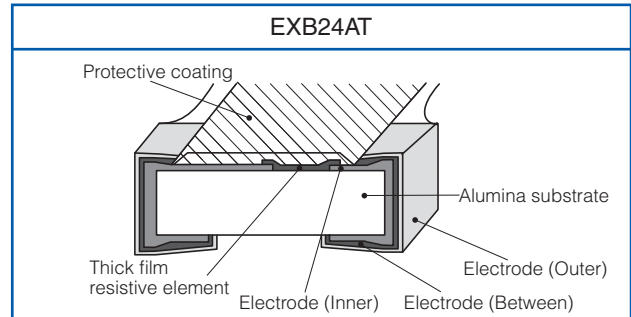
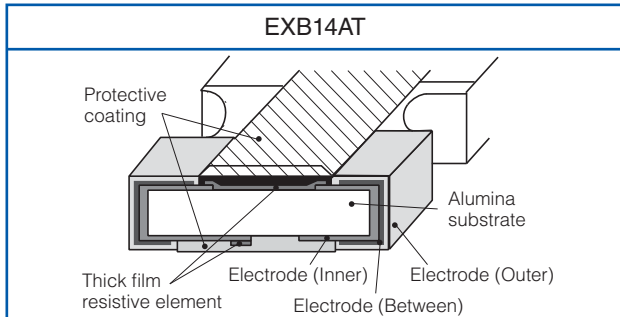

Dimensions in mm (not to scale)

EXB14AT

Dimensions (mm)	L	W	T	A	B	C	P (typical value)
	0.80 ^{+0.10}	0.60 ^{+0.10}	0.35 ^{+0.10}	0.35 ^{+0.10}	0.15 ^{+0.10}	0.15 ^{+0.10}	0.50

<Marking Configuration>
 The bar marking for recognizing terminal direction is located on the side of terminal 3, 4.
 Mass (Weight) [1000 pcs.] : 0.7 g

EXB24AT

Dimensions (mm)	L	W	T	A	B	C	P (typical value)
	1.00 ^{+0.10}	1.00 ^{+0.10}	0.35 ^{+0.10}	0.40 ^{+0.10}	0.15 ^{+0.10}	0.25 ^{+0.10}	0.65

<Marking Configuration>
 The bar marking for recognizing terminal direction is located on the side of terminal 4.
 Mass (Weight) [1000 pcs.] : 1.1 g

Ratings

Part No.	EXB14AT, EXB24AT
Attenuation Value	1 dB, 2 dB, 3 dB, 4 dB, 5 dB, 6 dB, 10 dB*
Attenuation Value Tolerance	1 dB, 2 dB, 3 dB, 4 dB, 5 dB : ±0.3 dB 6 dB, 10 dB : ±0.5 dB
Characteristic Impedance	50 Ω
Power Rating	0.04 W /package
Frequency Range at 70 °C	DC to 3.0 GHz
VSWR (Voltage Standing Wave Ratio)	1.3 max.
Number of Resistors	3 resistors
Number of Terminals	4 terminals
Category Temperature Range	-55 °C to +125 °C

* Please inquire about the other Attenuator value

Power Derating Curve

For resistors operated in ambient temperatures above 70 °C, power rating shall be derated in accordance with the figure on the right.

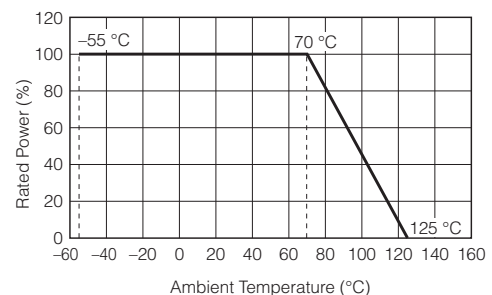

Surface Mount Resistors Series			Packaging (Standard Quantity : pcs./reel)			
Products	Part No.	Size mm (inch)	Pressed Carrier Taping (2 mm pitch)	Punched Carrier Taping (2 mm pitch)	Punched Carrier Taping (4 mm pitch)	Embossed Carrier Taping (4 mm pitch)
Thick Film Chip Resistors	ERJXGN	0402(01005)	20,000 *	—	—	4,000 **
	ERJ1GN	0603(0201)	15,000	—	—	—
	ERJ2GE	1005(0402)	—	10,000, 20,000	—	—
	ERJ3GE	1608(0603)	—	—	5,000	—
	ERJ6GE	2012(0805)	—	—	5,000	—
	ERJ8GE	3216(1206)	—	—	5,000	—
	ERJ14	3225(1210)	—	—	—	5,000
	ERJ12	4532(1812)	—	—	—	5,000
	ERJ12Z	5025(2010)	—	—	—	5,000
	ERJ1T	6432(2512)	—	—	—	4,000
Precision Thick Film Chip Resistors	ERJXGN	0402(01005)	20,000	—	—	—
	ERJ1GN/1RH	0603(0201)	15,000	—	—	—
	ERJ2RH/2RK	1005(0402)	—	10,000	—	—
	ERJ3RB/3RE/3EK	1608(0603)	—	—	5,000	—
	ERJ6RB/6RE/6EN	2012(0805)	—	—	5,000	—
	ERJ8EN	3216(1206)	—	—	5,000	—
	ERJ14N	3225(1210)	—	—	—	5,000
	ERJ12N	4532(1812)	—	—	—	5,000
	ERJ12S	5025(2010)	—	—	—	5,000
ERJ1TN	6432(2512)	—	—	—	4,000	
Metal Film Chip Resistors, High Reliability Type	ERA1A	0603(0201)	15,000	—	—	—
	ERA2A	1005(0402)	—	10,000	—	—
	ERA3A	1608(0603)	—	—	5,000	—
	ERA6A	2012(0805)	—	—	5,000	—
	ERA8A	3216(1206)	—	—	5,000	—
Thick Film Chip Resistors/ Low Resistance Type	ERJ2LW/2BW	1005(0402)	10,000	—	—	—
	ERJ2BS/2BQ	1005(0402)	—	10,000	—	—
	ERJ3L/3B/3R/L03	1608(0603)	—	—	5,000	—
	ERJ6B/6R/L06	2012(0805)	—	—	5,000	—
	ERJ8B/8R/8C/L08	3216(1206)	—	—	5,000	—
	ERJ14B/14R/L14	3225(1210)	—	—	—	5,000
	ERJ12R/L12	4532(1812)	—	—	—	5,000
	ERJ12Z/L1D	5025(2010)	—	—	—	5,000
	ERJ1TR	6432(2512)	—	—	—	4,000
Current Sensing Resistors, Metal Plate Type	ERJ1W	6432(2512)	—	—	—	3,000
	ERJMS4	6432(2512)	—	—	—	2,000
	ERJMS6	6468(2526)	—	—	—	1,000 (8 mm Pitch)
High Power Chip Resistors/ Wide Terminal Type	ERJM1W	6432(2512)	—	—	—	3,000
	ERJA1	3264(1225)	—	—	—	4,000
	ERJB1/ERJC1 ⁽¹⁾	2550(1020)	—	—	—	5,000
	ERJB2	1632(0612)	—	—	5,000	—
	ERJB3	1220(0508)	—	—	5,000	—

* W8P2 : Width 8 mm, Pitch 2 mm, ** W4P1 : Width 4 mm, Pitch 1 mm
 (1) Anti-Sulfurated High Power Chip Resistors / Wide Terminal Type

Surface Mount Resistors Series			Packaging (Standard Quantity : pcs./reel)			
Products	Part No.	Size mm (inch)	Pressed Carrier Taping (2 mm pitch)	Punched Carrier Taping (2 mm pitch)	Punched Carrier Taping (4 mm pitch)	Embossed Carrier Taping (4 mm pitch)
Anti-Surge Thick Film Chip Resistors	ERJP03/PA3	1608(0603)	—	—	5,000	—
	ERJP06	2012(0805)	—	—	5,000	—
	ERJP08	3216(1206)	—	—	5,000	—
	ERJP14	3225(1210)	—	—	—	5,000
Anti-Pulse Thick Film Chip Resistors	ERJT06	2012(0805)	—	—	5,000	—
	ERJT08	3216(1206)	—	—	5,000	—
	ERJT14	3225(1210)	—	—	—	5,000
Anti-Sulfurated Thick Film Chip Resistors	ERJU01	0603(0201)	15,000	—	—	—
	ERJS02/U02	1005(0402)	—	10,000	—	—
	ERJS03/U03	1608(0603)	—	—	5,000	—
	ERJS06/U06 ERJS6S/S6Q	2012(0805)	—	—	5,000	—
	ERJS08/U08	3216(1206)	—	—	5,000	—
	ERJS14/U14	3225(1210)	—	—	—	5,000
	ERJS12/U12	4532(1812)	—	—	—	5,000
	ERJS1D/U1D ERJS1T/U1T	5025(2010) 6432(2512)	— —	— —	— —	5,000 4,000
Chip Resistor Array	EXB14V	0806(0302)	—	10,000	—	—
	EXB24V	1010(0404)	—	10,000	—	—
	EXB34V	1616(0606)	—	—	5,000	—
	EXBV4V	1616(0606)	—	—	5,000	—
	EXB18V	1406(0502)	—	10,000	—	—
	EXB28V	2010(0804)	—	10,000	—	—
	EXBN8V	2010(0804)	—	10,000	—	—
	EXB38V	3216(1206)	—	—	5,000	—
	EXBV8V	3216(1206)	—	—	5,000	—
	EXBS8V	5022(2009)	—	—	—	2,500
	EXB2HV	3816(1506)	—	—	5,000	—
Metal Film Chip Resistor Array	ERA38V	3216(1206)	—	—	5,000	—
Anti-Sulfurated Chip Resistor Array	EXBU24	1010(0404)	—	10,000	—	—
	EXBU34	1616(0606)	—	—	5,000	—
	EXBU28	2010(0804)	—	10,000	—	—
	EXBU38	3216(1206)	—	—	5,000	—
	EXBU2H	3816(1506)	—	—	5,000	—
Chip Resistor Networks	EXBD	3216(1206)	—	—	5,000	—
	EXBE	4021(1608)	—	—	—	4,000
	EXBA	6431(2512)	—	—	—	4,000
	EXBQ	3816(1506)	—	—	5,000	—
Chip Attenuator	EXB14AT	0806(0302)	—	10,000	—	—
	EXB24AT	1010(0404)	—	10,000	—	—

Carrier Tape

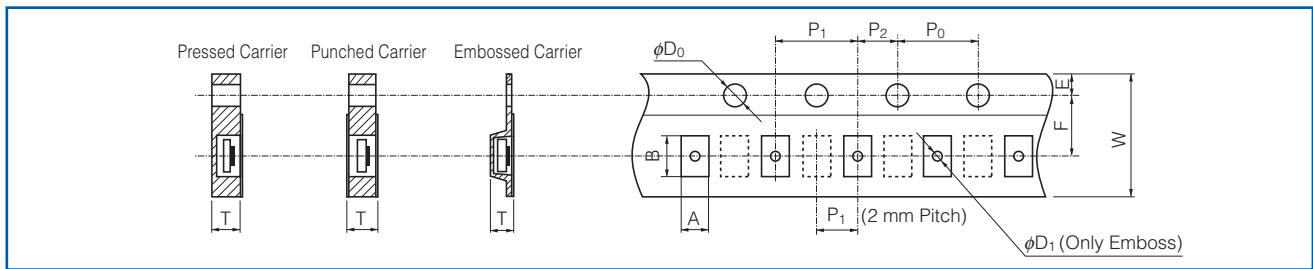

Pressed Carrier Taping (2 mm Pitch)

- Rectangular Type (Unit : mm)

Part No.	Size mm (inch)	A	B	W	F	E	P ₁	P ₂	P ₀	φD ₀	T
ERJXGN	0402(01005)	0.24 ^{±0.03}	0.45 ^{±0.03}	8.00 ^{±0.20}	3.50 ^{±0.05}	1.75 ^{±0.10}	2.00 ^{±0.10}	2.00 ^{±0.05}	4.00 ^{±0.10}	1.50 ^{+0.10} ₀	0.31 ^{±0.05}
ERJ1GN ERJ1R□ ERJU01 ERA1A	0603 (0201)	0.38 ^{±0.05}	0.68 ^{±0.05}								0.42 ^{±0.05}
ERJ2LW	1005(0402)	0.68 ^{±0.10}	1.20 ^{±0.10}								0.60 ^{±0.05}
ERJ2BW	1005(0402)	0.67 ^{±0.10}	1.17 ^{±0.10}								0.61 ^{±0.05}

Punched Carrier Taping (2 mm Pitch)

- Rectangular Type (Unit : mm)

Part No.	Size mm (inch)	A	B	W	F	E	P ₁	P ₂	P ₀	φD ₀	T
ERJ2□ ERJS02 ERJU02 ERA2A	1005 (0402)	0.67 ^{±0.05}	1.17 ^{±0.05}	8.00 ^{±0.20}	3.50 ^{±0.05}	1.75 ^{±0.10}	2.00 ^{±0.10}	2.00 ^{±0.05}	4.00 ^{±0.10}	1.50 ^{+0.10} ₀	0.52 ^{±0.05}

- Chip Resistor Array / Anti-Sulfurated Chip Resistor Array / Chip Attenuator (Unit : mm)

Part No.	Size mm (inch)	A	B	W	F	E	P ₁	P ₂	P ₀	φD ₀	T
EXB14V EXB14AT	0806 (0302)	0.70 ^{+0.10} _{-0.05}	0.95 ^{+0.05} _{-0.10}	8.00 ^{±0.20}	3.50 ^{±0.05}	1.75 ^{±0.10}	2.00 ^{±0.10}	2.00 ^{±0.05}	4.00 ^{±0.10}	1.50 ^{+0.10} ₀	0.52 ^{±0.05}
EXB18V	1406(0502)		1.60 ^{±0.10}								
EXB24V EXBU24 EXB24AT	1010 (0404)	1.20 ^{±0.10}	1.20 ^{±0.10}								
EXB28V EXBU28 EXBN8V	2010 (0804)		2.20 ^{±0.10}								

Punched Carrier Taping (4 mm Pitch)

- Rectangular Type (Unit : mm)

Part No.	Size mm (inch)	A	B	W	F	E	P ₁	P ₂	P ₀	φD ₀	T
ERJ3□ ERJ3LW(10 mΩ) ERJ3BW ERJ□□3 ERA3A	1608 (0603)	1.10 ^{±0.10}	1.90 ^{±0.10}	8.00 ^{±0.20}	3.50 ^{±0.05}	1.75 ^{±0.10}	4.00 ^{±0.10}	2.00 ^{±0.05}	4.00 ^{±0.10}	1.50 ^{+0.10} ₀	0.70 ^{±0.05}
ERJ3LW(5 mΩ)											
ERJ6□ ERJ□06 ERJS6□ ERA6A	2012 (0805)	1.65 ^{±0.15}	2.50 ^{±0.20}								0.84 ^{±0.05}
ERJB3	1220(0508)										
ERJ6BW	2012(0805)	1.55 ^{±0.15}	2.30 ^{±0.20}								
ERJ8□ ERJ8□W ERJ□08 ERA8A	3216 (1206)	2.00 ^{±0.15}	3.60 ^{±0.20}								
ERJB2	1632(0612)										

Panasonic Surface Mount Resistors Packaging Method (Taping)

● Chip Resistor Array / Metal Film Chip Resistor Array / Anti-Sulfurated Chip Resistor Array / Chip Resistor Networks (Unit : mm)

Part No.	Size mm (inch)	A	B	W	F	E	P ₁	P ₂	P ₀	φD ₀	T
EXB34V EXBU34	1616(0606)	1.95 ^{±0.15}	1.95 ^{±0.20}	8.00 ^{±0.20}	3.50 ^{±0.05}	1.75 ^{±0.10}	4.00 ^{±0.10}	2.00 ^{±0.05}	4.00 ^{±0.10}	1.50 ^{+0.10} ₀	0.70 ^{±0.05}
EXB38V ERA38V EXBU38	3216(1206)		3.60 ^{±0.20}								
EXB2HV EXBU2H	3816(1506)		4.10 ^{±0.15}								
EXBV4V	1616(0606)		1.95 ^{±0.20}								
EXBV8V	3216(1206)		3.60 ^{±0.20}								
EXBD	3216(1206)	2.00 ^{±0.20}	3.60 ^{±0.20}								0.84 ^{±0.05}
EXBQ	3816(1506)	1.90 ^{±0.20}	4.10 ^{±0.20}								0.84 ^{±0.10}
											0.64 ^{±0.05}

Embossed Carrier Taping (1 mm Pitch)

● Rectangular Type (Unit : mm)

Part No.	Size mm (inch)	A	B	W	F	E	P ₁	P ₂	P ₀	φD ₀	T
ERJXGN	0402(01005)	0.25 ^{±0.05}	0.45 ^{±0.05}	4.00 ^{±0.20}	1.80 ^{±0.05}	0.90 ^{±0.10}	1.00 ^{±0.10}	1.00 ^{±0.10}	2.00 ^{±0.10}	0.80 ^{±0.10}	0.5 max.

Embossed Carrier Taping (4 mm Pitch)

● Rectangular Type (Unit : mm)

Part No.	Size mm (inch)	A	B	W	F	E	P ₁	P ₂	P ₀	φD ₀	T	φD ₁	
ERJ14□ ERJ□14	3225 (1210)	2.80 ^{±0.20}	3.50 ^{±0.20}	8.00 ^{±0.30}	3.50 ^{±0.05}	1.75 ^{±0.10}	4.00 ^{±0.10}	2.00 ^{±0.05}	4.00 ^{±0.10}	1.50 ^{+0.10} ₀	1.00 ^{±0.10}	1.00 ^{±0.10}	
ERJ12□ ERJ□12	4532 (1812)	3.50 ^{±0.20}	4.80 ^{±0.20}	12.00 ^{±0.30}	5.50 ^{±0.20}								
ERJ12Z ERJ12S ERJ□1D	5025 (2010)	2.80 ^{±0.20}	5.30 ^{±0.20}										
ERJB1 ERJC1	2550 (1020)	3.60 ^{±0.20}	6.90 ^{±0.20}	12.00 ^{±0.30}	5.50 ^{±0.20}								
ERJ1T□ ERJ□1T	6432 (2512)												1.60 ^{±0.10}
ERJL1W ERJM1W ERJMS4													
ERJA1	3264(1225)	3.50 ^{±0.20}	6.80 ^{±0.20}										

● Chip Resistor Array / Chip Resistor Networks (Unit : mm)

Part No.	Size mm (inch)	A	B	W	F	E	P ₁	P ₂	P ₀	φD ₀	T	φD ₁
EXBS8V	5022(2029)	2.80 ^{±0.20}	5.70 ^{±0.20}	12.00 ^{±0.30}	5.50 ^{±0.20}	1.75 ^{±0.10}	4.00 ^{±0.10}	2.00 ^{±0.05}	4.00 ^{±0.10}	1.50 ^{+0.10} ₀	1.6 max.	1.5 min.
EXBE	4021(1608)	2.50 ^{±0.20}	4.40 ^{±0.20}								1.10 ^{±0.20}	
EXBA	6431(2512)	3.50 ^{±0.20}	6.80 ^{±0.20}									

Embossed Carrier Taping (8 mm Pitch)

● Rectangular Type (Unit : mm)

Part No.	Size mm (inch)	A	B	W	F	E	P ₁	P ₂	P ₀	φD ₀	T	φD ₁
ERJMS6	6468(2526)	6.90 ^{±0.20}	7.50 ^{±0.20}	12.00 ^{±0.30}	5.50 ^{±0.05}	1.75 ^{±0.10}	8.00 ^{±0.10}	2.00 ^{±0.05}	4.00 ^{±0.10}	1.50 ^{+0.10} ₀	2.10 ^{±0.10}	1.5 min.

Taping Reel

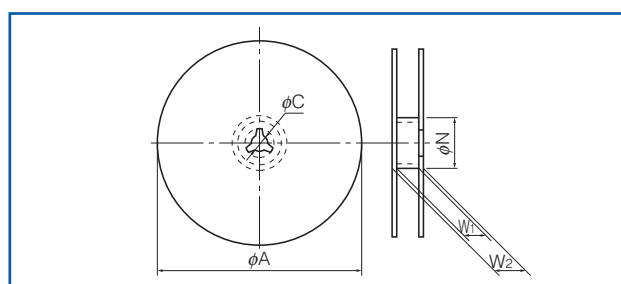

(Unit : mm)

Tape Width (W)	φA	φN	φC	W ₁	W ₂
4mm Width	180.0 ^{±3.0}	60.0 ^{+1.0} ₀	13.0 ^{±0.2}	4.5 ^{±0.5}	7.0 ^{±0.5}
8mm Width	180.0 ^{+0.0} _{-1.5}			9.0 ^{+1.0} ₀	11.4 ^{±1.0}
12mm Width				13.0 ^{+1.0} ₀	15.4 ^{±1.0}
24mm Width	380.0 ^{±2.0}	80.0 ^{±1.0}		25.4 ^{±1.0}	29.4 ^{±1.0}

Design and specifications are each subject to change without notice. Ask factory for the current technical specifications before purchase and/or use.
Should a safety concern arise regarding this product, please be sure to contact us immediately.

09 Nov. 2014

Recommended Land Pattern

- An example of a land pattern for the Rectangular Type is shown below.

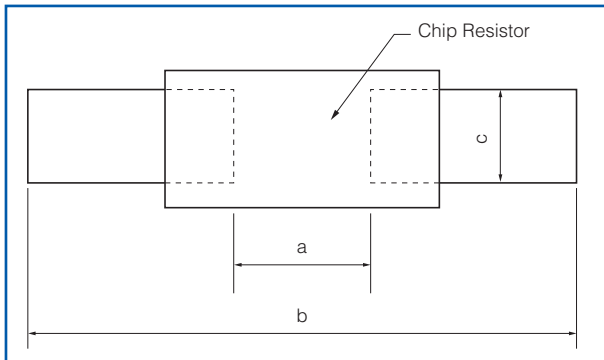

Size mm/inch	Dimensions (mm)		
	a	b	c
0402/01005	0.15 to 0.20	0.5 to 0.7	0.20 to 0.25
0603/0201	0.3 to 0.4	0.8 to 0.9	0.25 to 0.35
1005/0402	0.5 to 0.6	1.4 to 1.6	0.4 to 0.6
1608/0603	0.7 to 0.9	2.0 to 2.2	0.8 to 1.0
2012/0805	1.0 to 1.4	3.2 to 3.8	0.9 to 1.4
3216/1206	2.0 to 2.4	4.4 to 5.0	1.2 to 1.8
3225/1210	2.0 to 2.4	4.4 to 5.0	1.8 to 2.8
4532/1812	3.3 to 3.7	5.7 to 6.5	2.3 to 3.5
5025/2010	3.6 to 4.0	6.2 to 7.0	1.8 to 2.8
6432/2512	5.0 to 5.4	7.6 to 8.6	2.3 to 3.5
6432/2512*	3.6 to 4.0	7.6 to 8.6	2.3 to 3.5

High power (double-sided resistive elements structure) type

Part No.	Size mm/inch	Dimensions (mm)		
		a	b	c
ERJ2LW/2BW	1005/0402	0.52	1.4 to 1.6	0.4 to 0.6
ERJ3LW/3BW	1608/0603	0.5 to 0.8	2.5 to 2.7	0.9 to 1.1
ERJ6BW	2012/0805	0.9	3.2 to 3.8	1.1 to 1.4
ERJ8BW	3216/1206	1.2	4.4 to 5.0	1.3 to 1.8
ERJ8CW (10 to 16 mΩ)				
ERJ8CW (18 to 50 mΩ)	3216/1206	2.0 to 2.6	4.4 to 5.0	1.2 to 1.8

* ERJL1W

- An example of a land pattern for High Power Chip Resistors / Wide Terminal Type is shown below.

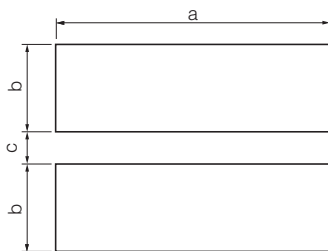

Part No.	Dimensions (mm)		
	a	b	c
ERJA1	6.4	1.70	0.60
ERJB1 ERJC1 ⁽¹⁾	5.0	1.30	0.75
ERJB2	3.2	0.95	0.70
ERJB3	2.0	0.80	0.60

(1) Anti-Sulfurated High Power Chip Resistors / Wide Terminal Type

● An example of a land pattern for Chip Resistor Array, Metal Film Chip Resistor Array, Anti-Sulfurated Chip Resistor Array and Chip Attenuator is shown below.

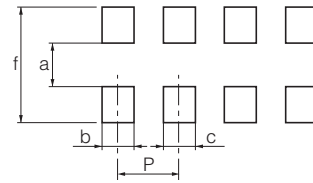
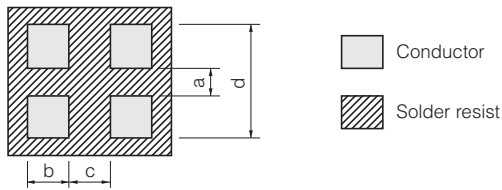

Part No.	Dimensions (mm)			
	a	b	c	d
EXB14V EXB14A	0.30	0.30	0.30	0.80 to 0.90
EXB24V EXBU24 EXB24A	0.5	0.35 to 0.40	0.30	1.4 to 1.5

Part No.	Dimensions (mm)				
	a	b	c	f	P
EXB18V	0.20 to 0.30	0.15 to 0.20	0.15 to 0.20	0.80 to 0.90	0.40
EXBV4V,V8V	0.7 to 0.9	0.4 to 0.45	0.4 to 0.45	2 to 2.4	0.80
EXB34V,38V EXBU34,U38 ERA38V	0.7 to 0.9	0.4 to 0.5	0.4 to 0.5	2.2 to 2.6	0.80
EXBS8V	1 to 1.2	0.5 to 0.75	0.5 to 0.75	3.2 to 3.8	1.27

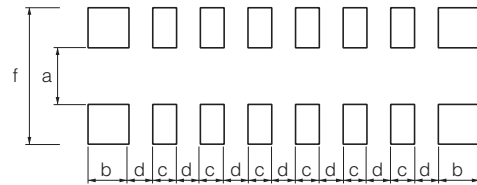
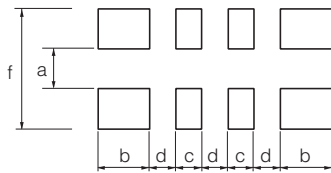

Part No.	Dimensions (mm)				
	a	b	c	d	f
EXB28V EXBU28	0.40	0.525	0.25	0.25	1.40
EXBN8V	0.45 to 0.50	0.35 to 0.38	0.25	0.25	1.40 to 2.00

Part No.	Dimensions (mm)				
	a	b	c	d	f
EXB2HV EXBU2H	1.00	0.425	0.25	0.25	2.00

● An example of a land pattern for Chip Resistor Networks is shown below.

	EXBA	EXBE
For popular pattern	Pitch 1.27 mm 	Pitch 0.8 mm
For high density pattern*	Pitch 0.635 mm Through-hole less EXBA10P EXBA10E 	Pitch 0.4 mm Through-hole less
	EXBD	EXBQ
For popular pattern	Pitch 0.635 mm 	Pitch 0.5 mm

* When designing high density land patterns, examine the reliability of isolation among the lines and adopt the chip resistor networks.

Recommended Soldering Conditions

Recommendations and precautions are described below.

● Rectangular Type

● Recommended soldering conditions for reflow

- Reflow soldering shall be performed a maximum of two times.
- Please contact us for additional information when used in conditions other than those specified.
- Please measure the temperature of the terminals and study every kind of solder and printed circuit board for solderability before actual use.

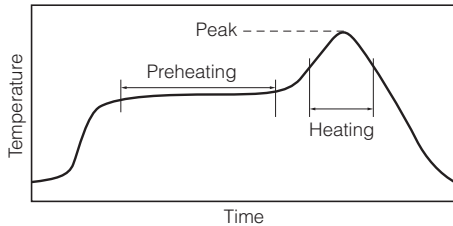

For soldering (Example : Sn/Pb)

	Temperature	Time
Preheating	140 °C to 160 °C	60 s to 120 s
Main heating	Above 200 °C	30 s to 40 s
Peak	235 ± 5 °C	max. 10 s

For lead-free soldering (Example : Sn/Ag/Cu)

	Temperature	Time
Preheating	150 °C to 180 °C	60 s to 120 s
Main heating	Above 230 °C	30 s to 40 s
Peak	max. 260 °C	max. 10 s

● Recommended soldering conditions for flow

	For soldering		For lead-free soldering	
	Temperature	Time	Temperature	Time
Preheating	140 °C to 180 °C	60 s to 120 s	150 °C to 180 °C	60 s to 120 s
Soldering	245 ± 5 °C	20 s to 30 s	max. 260 °C	max. 10 s

● Chip Resistor Array, Chip Resistor Networks and Chip Attenuator

● Recommended soldering conditions for reflow

- Reflow soldering shall be performed a maximum of two times.
- Please contact us for additional information when used in conditions other than those specified.
- Please measure the temperature of the terminals and study every kind of solder and printed circuit board for solderability before actual use.

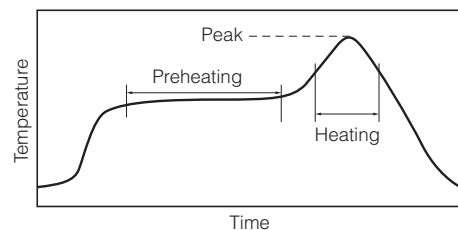

For soldering (Example : Sn/Pb)

	Temperature	Time
Preheating	140 °C to 160 °C	60 s to 120 s
Main heating	Above 200 °C	30 s to 40 s
Peak	235 ± 5 °C	max. 10 s

For lead-free soldering (Example : Sn/Ag/Cu)

	Temperature	Time
Preheating	150 °C to 180 °C	60 s to 120 s
Main heating	Above 230 °C	30 s to 40 s
Peak	max. 260 °C	max. 10 s

● Flow soldering

We do not recommend flow soldering, because a solder bridge may form. Please contact us regarding flow soldering of EXBA series.

⚠ Safety Precautions (Common precautions for Surface Mount Resistors)

The following are precautions for individual products. Please also refer to the common precautions for Fixed Resistors in this catalog.

1. Take measures against mechanical stress during and after mounting of Surface Mount Resistors (hereafter called the resistors) so as not to damage their electrodes and protective coatings.
Be careful not to misplace the resistors on the land patterns. Otherwise, solder bridging may occur.
2. Keep the rated power and ambient temperature within the specified derating curve.
Some circuit boards, wiring patterns, temperatures of heat generated by adjacent components, or ambient temperatures can become factors in the rise of the temperature of the resistors, regardless of the level of power applied. Therefore, check the conditions before use and optimize them so as not to damage the boards and peripheral components.
Make sure to contact us before using the resistors under special conditions.
3. If a transient load (heavy load in a short time) like a pulse is expected to be applied, check and evaluate the operations of the resistors when installed in your products before use.
Never exceed the rated power. Otherwise, the performance and/or reliability of the resistors may be impaired.
4. Before using halogen-based or other high-activity flux, check the possible effects of the flux residues on the performance and reliability of the resistors.
5. When soldering with a soldering iron, never touch the resistors' bodies with the tip of the soldering iron. When using a soldering iron with a high temperature tip, finish soldering as quickly as possible (within three seconds at 350 °C max.).
6. As the amount of applied solder becomes larger, the mechanical stress applied to the resistors increases, causing problems such as cracks and faulty characteristics. Avoid applying an excessive amounts of solder.
7. When the resistors' protective coatings are chipped, flawed, or removed, the characteristics of the resistors may be impaired. Take special care not to apply mechanical shock during automatic mounting or cause damage during handling of the boards with the resistors mounted.
8. Do not apply shock to the resistors or pinch them with a hard tool (e.g. pliers and tweezers). Otherwise, the resistors' protective coatings and bodies may be chipped, affecting their performance.
9. Avoid excessive bending of printed circuit boards in order to protect the resistors from abnormal stress.
10. Do not immerse the resistors in solvent for a long time. Before using solvent, carefully check the effects of immersion.
11. Transient voltage
If there is a possibility that the transient phenomenon (significantly high voltage applied in a short time) may occur or that a high voltage pulse may be applied, make sure to evaluate and check the characteristics of Fixed Metal (Oxide) Film Resistors mounted on your product rather than only depending on the calculated power limit or steady-state conditions to complete the design or decide to use the resistors.
12. Do not apply excessive tension to the terminals.

Metal (Oxide) Film Resistors

Type: **ERG(X)S (Small size)**
(0.5 W, 1 W, 2 W, 3 W, 5 W)
ERG(X)F (Anti-heat conducting for PCB)
(1 W, 2 W, 3 W, 5 W)

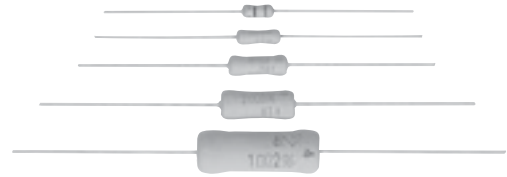

Features

- Miniaturized
50 % smaller compared to existing models
- Non-flammable
- High Reliability
- Automatic Insertion
- Reference Standards
IEC 60115-2, IEC 60115-4, JIS C 5201-4, EIAJ RC-2138
- RoHS compliant

Explanation of Part Numbers

Ex.1 : ERX type

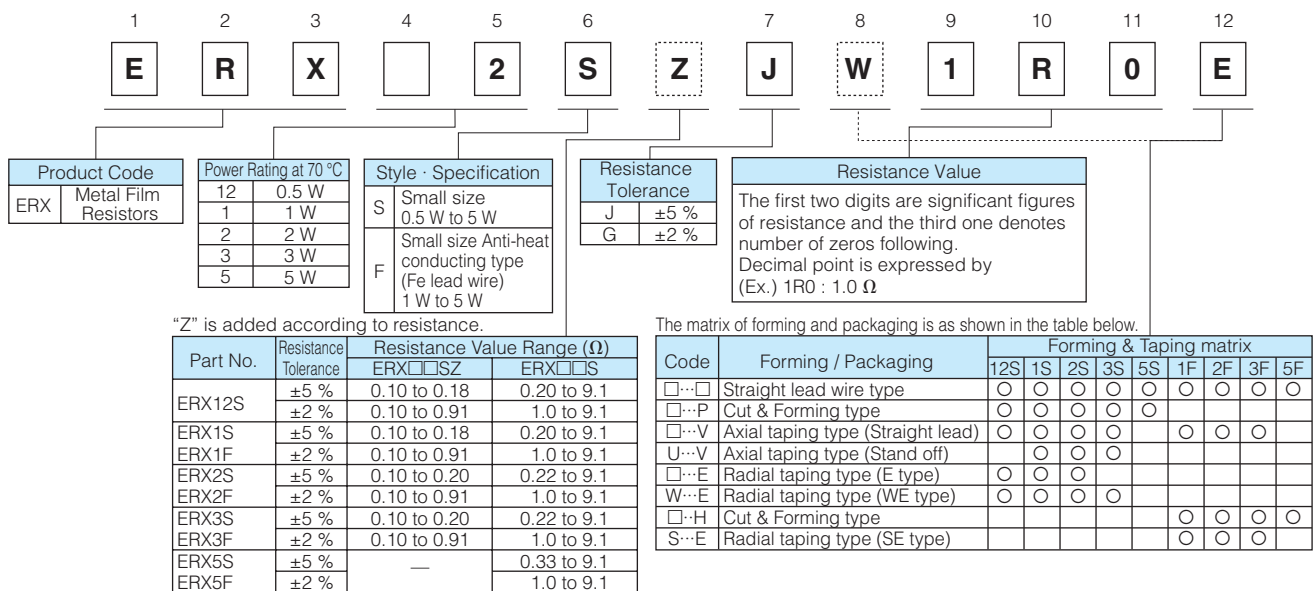

The above example 1 shows a small metal film resistor, 2 W power rating, resistance value of 1.0 Ω, tolerance ±5 %, and package of radial taping.

Ex.2 : ERG type

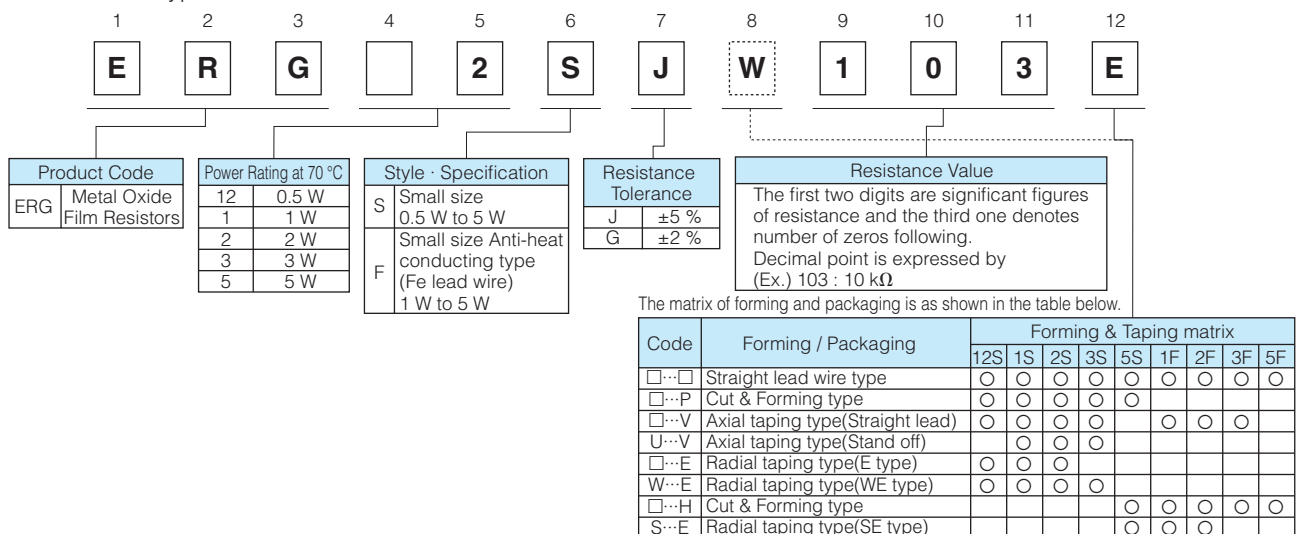

The above example 2 shows a small metal oxide film resistor, 2 W power rating, resistance value of 10 kΩ, tolerance ±5 %, and package of radial taping.

Construction

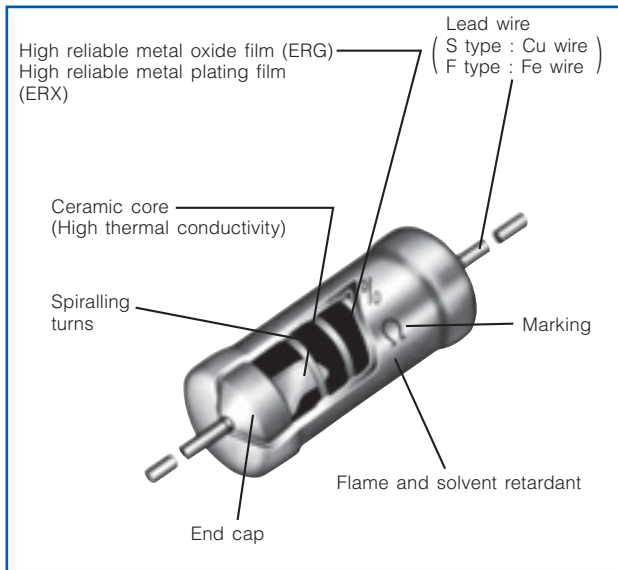

Dimensions in mm (not to scale)

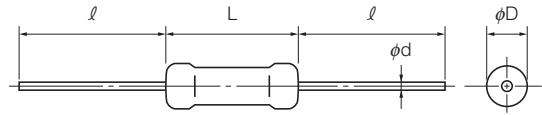

Part No.	Dimensions (mm)				Mass (Weight) [g/pc.]
	L	φD	ℓ	φd	
ERG(X)12S	6.35 ^{+0.65} _{-0.35}	2.3 ^{+0.5} _{-0.3}	30.0 ^{±3.0}	0.65 ^{±0.05}	0.26
ERG(X)1S	9.00 ^{+1.50} _{-1.00}	2.8 ^{±0.5}	30.0 ^{±3.0}	0.65 ^{±0.05}	0.33
ERG(X)1F				0.80 ^{±0.05}	
ERG(X)2S	12.00 ^{+1.50} _{-1.00}	4.0 ^{±1.0}	30.0 ^{±3.0}	0.80 ^{±0.05}	0.66
ERG(X)2F					
ERG(X)3S	15.00 ^{±1.50}	5.5 ^{±1.0}	38.0 ^{±3.0}	0.80 ^{±0.05}	1.47
ERG(X)3F					
ERG(X)5S	24.00 ^{±1.50}	8.0 ^{±1.0}	38.0 ^{±3.0}	0.80 ^{±0.05}	3.54
ERG(X)5F					

Ratings

Part No.	Power Rating at 70 °C (W)	Limiting Element Voltage ⁽¹⁾ (V)	Maximum Overload Voltage ⁽²⁾ (V)	Maximum Intermittent Overload Voltage ⁽³⁾ (V)	Dielectric Withstanding Voltage (VAC)	Res. Tol. (%) ⁽⁴⁾	Resistance Range (Ω) ⁽⁵⁾		T.C.R. (×10 ⁻⁶ /°C)	Standard Resistance Value
							min. ⁽⁶⁾	max.		
ERG(X)12S	0.5	300	600	600	350	G (±2)	1	22 k	±350	E24
						J (±5)	0.2	47 k		
ERG(X)1S	1	350	600	600	350	G (±2)	1	68 k	±350	E24
ERG(X)1F						J (±5)	0.2	100 k		
ERG(X)2S	2	350	700	1000	600	G (±2)	1	100 k	±350	E24
ERG(X)2F						J (±5)	0.22	100 k		
ERG(X)3S	3	350	700	1000	1000	G (±2)	1	100 k	±300	E24
ERG(X)3F						J (±5)	0.22	100 k		
ERG(X)5S	5	500	1000	1500	1000	G (±2)	1	100 k	±200	E24
ERG(X)5F						J (±5)	0.33	100 k		

- (1) Rated Continuous Working Voltage (RCWV) shall be determined from $RCWV = \sqrt{\text{Power Rating} \times \text{Resistance Value}}$ or Limiting Element Voltage listed above whichever less.
- (2) Overload (Short-time Overload) Test Voltage (SOTV) shall be determined from $SOTV = 2.5 \times \text{Power Rating}$ or max. Overload Voltage listed above whichever less.
- (3) Intermittent Overload Test Voltage (IOTV) shall be determined from $IOTV = 4.0 \times \text{Power Rating}$ or max. Intermittent Overload Voltage listed above whichever less.

- (4) Resistance tolerance is of use besides range listed, please inquire.
- (5) Resistance Range Type ERG : $\geq 10 \Omega$
Type ERX : $\leq 9.1 \Omega$
- (6) As for the low resistance value range, "Z" is given to the part number. (Refer to the explanation of part numbers.)

* Z type is non standard resistance values.

Code	Part No.	Res. Tol.	Res. Value Range	Code	Part No.	Res. Tol.	Res. Value Range
Z	12S	±2 %	0.1 to 0.91 Ω	Z	2S	±2 %	0.1 to 0.91 Ω
		±5 %	0.1 to 0.18 Ω		2F	±5 %	0.1 to 0.2 Ω
	±2 %	0.1 to 0.91 Ω	3S		±2 %	0.1 to 0.91 Ω	
	±5 %	0.1 to 0.18 Ω	3F		±5 %	0.1 to 0.2 Ω	

Power Derating Curve

For resistors operated in ambient temperatures above 70 °C, power rating shall be derated in accordance with the figure on the right.

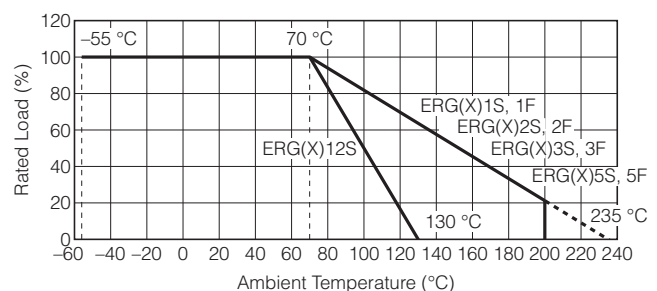

Taped & Box

ERG(X)□□S□□□□V

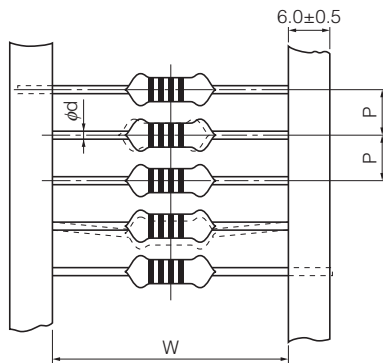

Stand-off Taped & Box

ERG(X)□□S□□□□V

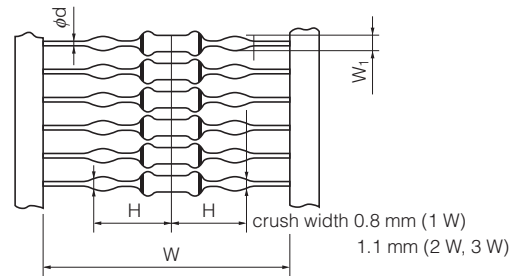

Part Number	Standard Quantity (pcs./box)	Taping (mm)						Box (mm)		
		P	50×P	W	H	W ₁	φd	a	b	c
ERG(X) 12S□□□□□V	2,000	5.0 ^{+0.3}	250 ⁺²	52.0 ^{+1.5}	—	—	0.65 ^{+0.05}	85	80	255
ERG(X) 1S□□□□□V	2,000	5.0 ^{+0.3}	250 ⁺²	52.0 ^{+1.5}	—	—	0.65 ^{+0.05}	85	80	255
ERG(X) 1S□□□□□V					12.0 ^{-0.2,0}	1.20 ^{+0.15,0}				
ERG(X) 2S□□□□□V	1,000	5.0 ^{+0.3}	250 ⁺²	52.0 ^{+1.5}	—	—	0.80 ^{+0.05}	85	80	255
ERG(X) 2S□□□□□V					15.5 ^{-0.2,0}	1.40 ^{+0.15,0}				
ERG(X) 3S□□□□□V	1,000	10.0 ^{+0.5}	500 ⁺²	74.0 ^{+2.0}	—	—	0.80 ^{+0.05}	105	100	325
ERG(X) 3S□□□□□V					23.0 ^{-0.2,0}	1.4 ^{+0.15,0}				

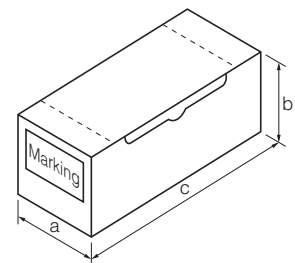

Cut & Formed Type

ERG(X)□□S□□□□P

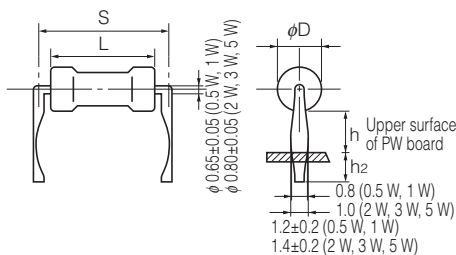

Part Number	Standard Quantity (pcs./box)	Dimensions (mm)				
		L	φD	S	h	h ₂
ERG(X) 12S□□□□□P	1,000	6.35 ^{+0.65, -0.35}	2.3 ^{+0.5, -0.3}	10.0 ^{+1.5}	4.0 ^{+1.5}	4.0 ^{+1.5}
ERG(X) 1S□□□□□P	1,000	9.00 ^{+1.50, -1.00}	2.8 ^{+0.5}	12.5 ^{+1.5}	4.0 ^{+1.5}	4.0 ^{+1.5}
ERG(X) 2S□□□□□P	1,000	12.00 ^{+1.50, -1.00}	4.0 ^{+1.0}	15.0 ^{+1.5}	6.0 ^{+1.5}	4.0 ^{+1.5}
ERG(X) 3S□□□□□P	1,000	15.00 ^{+1.50}	5.5 ^{+1.0}	20.0 ^{+2.0}	6.5 ^{+1.5}	4.0 ^{+1.5}
ERG(X) 5S□□□□□P	500	24.00 ^{+1.50}	8.0 ^{+1.0}	30.0 ^{+2.0}	7.5 ^{+1.5}	4.0 ^{+1.5}

ERG(X)□F□□□□□H

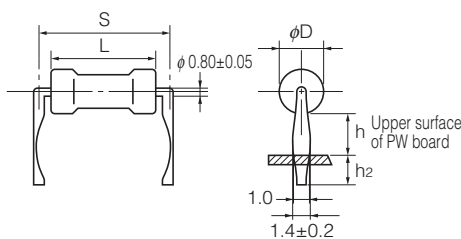

Part Number	Standard Quantity (pcs./box)	Dimensions (mm)				
		L	φD	S	h	h ₂
ERG(X) 1F□□□□□H	1,000	9.0 ^{+1.5, -1.0}	2.8 ^{+0.5}	12.5 ^{+1.5}	8 ⁺²	4.0 ^{+1.5}
ERG(X) 2F□□□□□H	1,000	12.0 ^{+1.5, -1.0}	4.0 ^{+1.0}	15.0 ^{+1.5}	6 ⁺²	5.0 ^{+1.5}
ERG(X) 3F□□□□□H	1,000	15.0 ^{+1.5}	5.5 ^{+1.0}	20.0 ^{+2.0}	10 ⁺²	5.0 ^{+1.5}
ERG(X) 5F□□□□□H	500	24.0 ^{+1.5}	8.0 ^{+1.0}	30.0 ^{+2.0}	10 ⁺²	5.0 ^{+1.5}

For Panasert Automatic Insertion Machine Radial Taped & Box

ERG(X)□□□□□□E (12S, 1S, 2S)

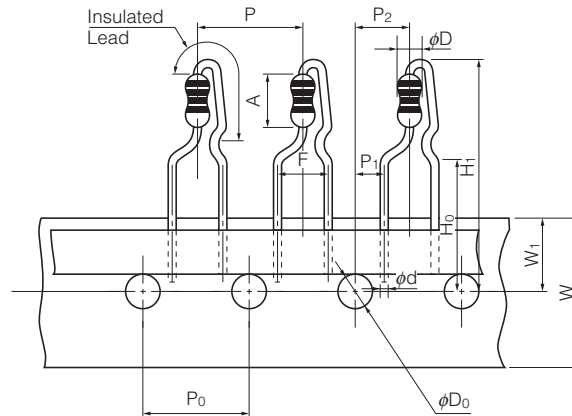

Dimensions (mm)		Dimensions (mm)		Dimensions (mm)		Dimensions (mm)		Dimensions (mm)	
P	12.7±1.0	W	18.0±0.5	H ₁	12S	32 max.	A	12S	6.35 ^{+0.65} _{-0.35}
P ₀	12.7±0.3	W ₁	9.0±0.5		1S	32 max.		1S	9.0 ^{+1.5} _{-1.0}
P ₁	3.85±0.70				2S	38 max.		2S	12.0 ^{+1.5} _{-1.0}
P ₂	6.35±1.00			H ₀	16.0±0.5		phi d	0.65±0.05	
F	5.0±0.8			phi D ₀	4.0±0.2				

● Radial Tape Package Specifications

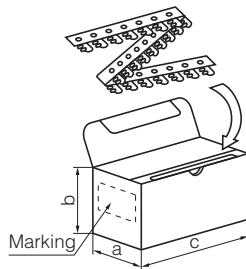

Part Number	Dimensions (mm)			Standard Quantity (pcs./box)
	a	b	c	
ERG(X) 12S□□□□□E	46	130	335	2,000
ERG(X) 1S□□□□□E	46	130	335	2,000
ERG(X) 2S□□□□□E	49	100	335	1,000

For Panasert Automatic Insertion Machine Radial Taped & Box

ERG(X)□□□□W□□□□E (12S, 1S, 2S, 3S)

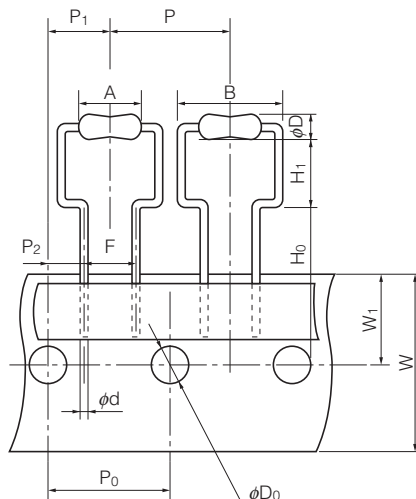

P	Dimensions (mm)		Dimensions (mm)		
			phi D ₀	12S, 1S, 2S, 3S	
P	12S	12.7±1.0	A	4.0±0.2	
	1S, 2S, 3S	30.0±1.0		12S	6.35 ^{+0.65} _{-0.35}
P ₀	12S	12.7±0.3		1S	9.0 ^{+1.5} _{-1.0}
	1S, 2S, 3S	15.0±0.3		2S	12.0 ^{+1.5} _{-1.0}
P ₁	12S	6.35±1.00		3S	15.0±1.5
	1S, 2S, 3S	7.5±1.0		B	12S
P ₂	12S	3.85±0.70	1S		14.0 max.
	1S, 2S, 3S	3.75±0.50	2S		17.0 max.
F	12S	5.0±0.5	3S	21.0 max.	
	1S, 2S, 3S	7.5±0.8	phi D	12S	2.3 ^{+0.5} _{-0.3}
W	12S, 1S, 2S, 3S	18.0±0.5		1S	2.8±0.5
W ₁	12S, 1S, 2S, 3S	9.0±0.5		2S	4.0±1.0
H ₀	12S	16.0±0.5		3S	5.5±1.0
	1S, 2S	18.0±1.0	phi d	12S	phi 0.65±0.05
	3S	19.0±1.0		1S, 2S, 3S	phi 0.80±0.05
H ₁	12S	6.5 ^{+0.6} ₀			
	1S, 2S	6.5 ^{+1.0} ₀			
	3S	8.0 ^{+1.0} ₀			

Design and specifications are each subject to change without notice. Ask factory for the current technical specifications before purchase and/or use. Should a safety concern arise regarding this product, please be sure to contact us immediately.

For Panasert Automatic Insertion Machine Radial Taped & Box

ERG(X)□F□S□□□E (1F, 2F, 3F)

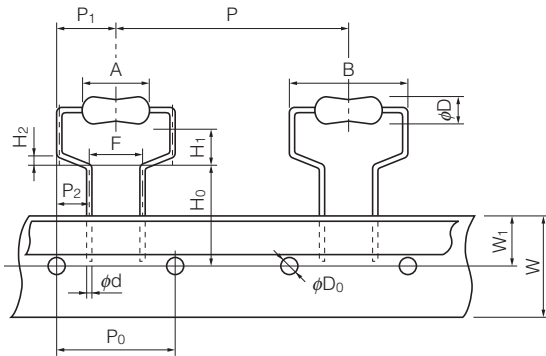

Dimensions (mm)		Dimensions (mm)	
P	30.0±1.0	H ₂	1.0±0.3
P ₀	15.0±0.3	φD ₀	4.0±0.2
P ₁	7.5±1.0	A	1F 9.0 ^{+1.5} _{-1.0}
P ₂	3.75±0.50		2F 12.0 ^{+1.5} _{-1.0}
F	7.5±0.8		3F 15.0±1.5
W	18.0±0.5	B	1F 14 max.
W ₁	9.0±0.5		2F 17 max.
H ₀	16.0 ^{+1.0} ₀		3F 21 max.
H ₁	1F	φD	1F 2.8±0.5
	2F		2F 4.0±1.0
	3F		3F 5.5±1.0
		φd	0.80±0.05

● Radial Tape Package Specifications

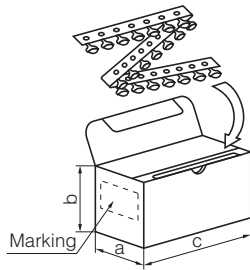

Part No.	Dimensions (mm)			Standard Quantity (pcs./box)
	a	b	c	
ERG(X)12S□W□□□E	46	145	325	2,000
ERG(X) 1S□W□□□E	49	150	317	1,000
ERG(X) 1F□ S□□□E				
ERG(X) 2S□W□□□E	49	150	317	500
ERG(X) 2F□ S□□□E				
ERG(X) 3F□ S□□□E	49	190	315	500

Hot-spot Temperature (for Reference)

The temperature of the resistor body increases with the curve below. A touching vinyl wire may cause damages to resistor element. Do not place vinyl wires around resistors and be sure to consider where the resistors will be placed.

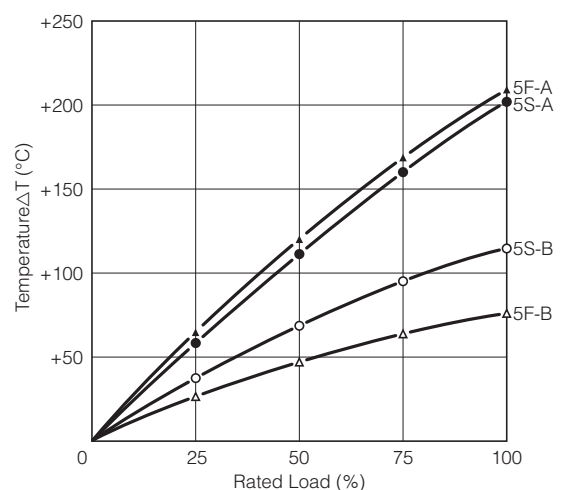
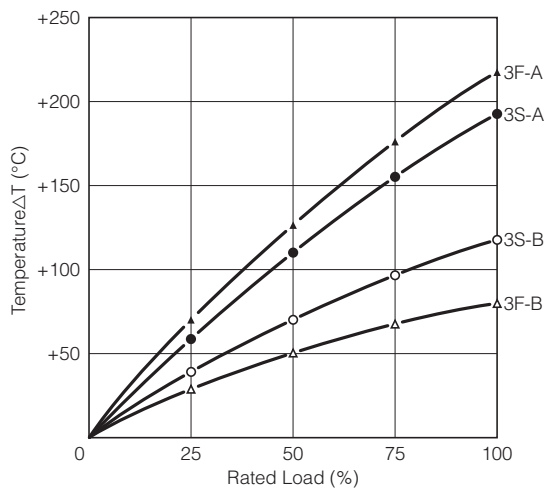
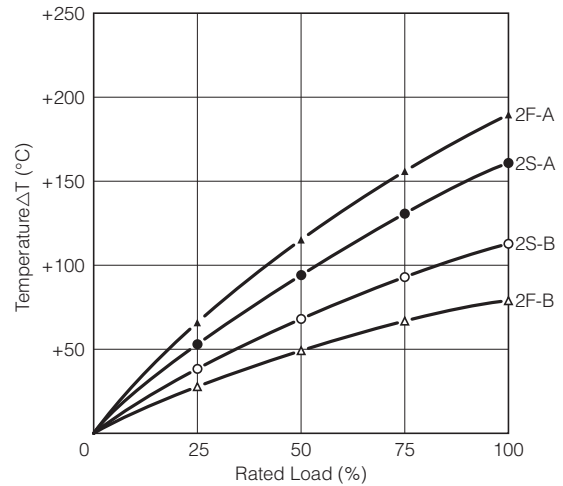
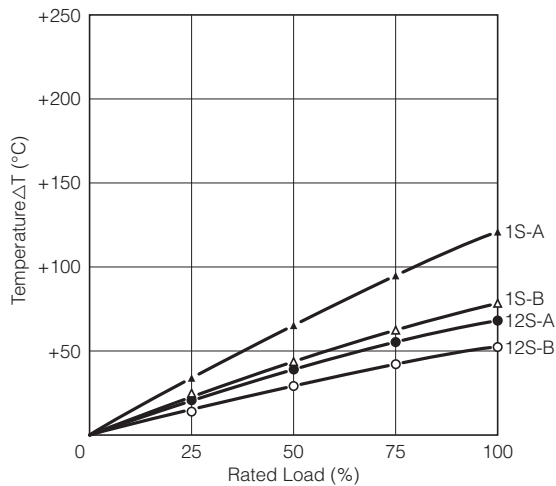
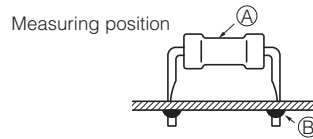

⚠ Safety Precautions

The following are precautions for individual products. Please also refer to the common precautions for Fixed Resistors in this catalog.

1. Transient voltage

If there is a possibility that the transient phenomenon (significantly high voltage applied in a short time) may occur or that a high voltage pulse may be applied, make sure to evaluate and check the characteristics of Metal(Oxide) Film Resistors (hereafter called the resistors) mounted on your product rather than only depending on the calculated power limit or steady-state conditions to complete the design or decide to use the resistors.

- The resistors are covered with a special coating. Do not apply shock or vibration to them, or pinch them with long-nose pliers. Otherwise, the resistors may be damaged.
- Do not apply excessive tension to the lead-connected sections. When bending the lead wire, do not apply excessive stress to the resistors and provide the wire with a natural curvature.
- Do not brush the resistors during or after the cleaning process, which may be conducted after soldering. Otherwise, the coating film may be damaged.

(Data for Reference)

Pulse Characteristics (Usual)

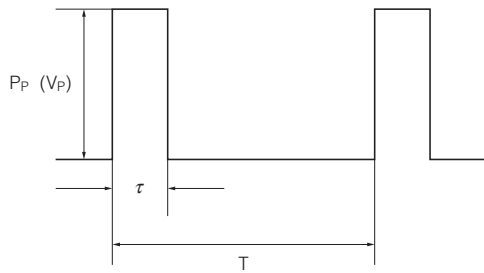

P_p : Pulse limit power (W)
 V_p : Pulse limit voltage (V)
 τ : Pulse continuous time (s)
 T : Period (s)
 V_R : Rated voltage (V)
 P : Rated power (W)
 R : Resistance value (Ω)
 $V_{p\ max.}$: Max. pulse limit voltage (V)

Withstand pulse limit power is calculated by the next method.

$$P_p = K \cdot P \cdot T / \tau$$

$$V_p = \sqrt{K \cdot P \cdot R \cdot T / \tau}$$

Reference to the right about a fixed number of $V_{p\ max.}$

- $T > 1(s) \rightarrow T = 1(s)$
- $T / \tau > 100 \rightarrow T / \tau = 100$
- $P_p < P \rightarrow P$ stands for P_p
($V_p < V_R \rightarrow V_R$ stands for V_p)
- Added voltage $\leq V_{p\ max.}$
- P_p or V_p is referent value
Conditions: Pulse added time=1000 h
Resistance change= $\pm 5\%$
Room temperature

Part No.	K	$V_{p\ max.}$ (V)
ERG(X) 12S	0.5	600
ERG(X) 1S	0.5	600
ERG(X) 2S	0.5	700
ERG(X) 3S	0.5	700
ERG(X) 5S	0.5	1000

Anti-Pulse Power Resistors

Type: **ERGD**
(0.5 W, 1 W, 2 W, 3 W)



Features

- Miniaturized
- Non-flammable
- Anti-Pulse Characteristic
- Automatic Insertion
- RoHS compliant

Explanation of Part Numbers

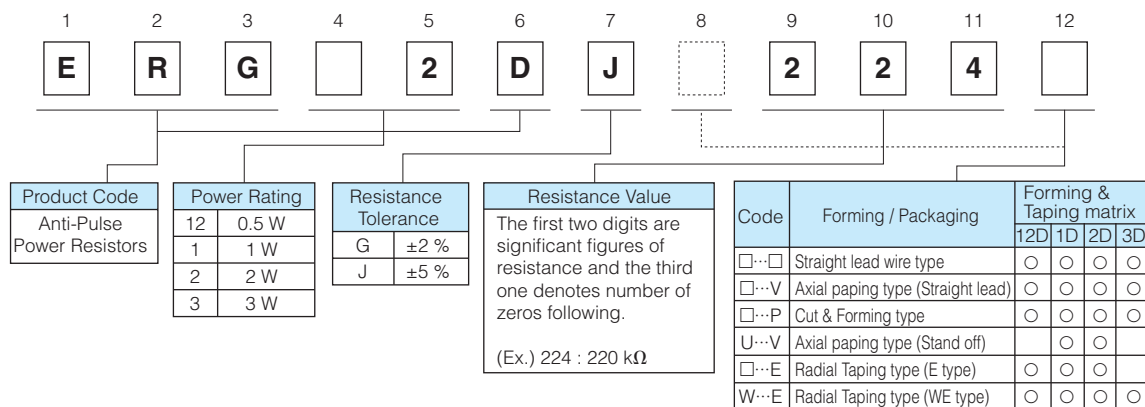

The above example shows an anti-pulse resistor, 2 W power rating, resistance value of 220 k ohms, tolerance ±5 %, and package of standard bulk packing.

Construction

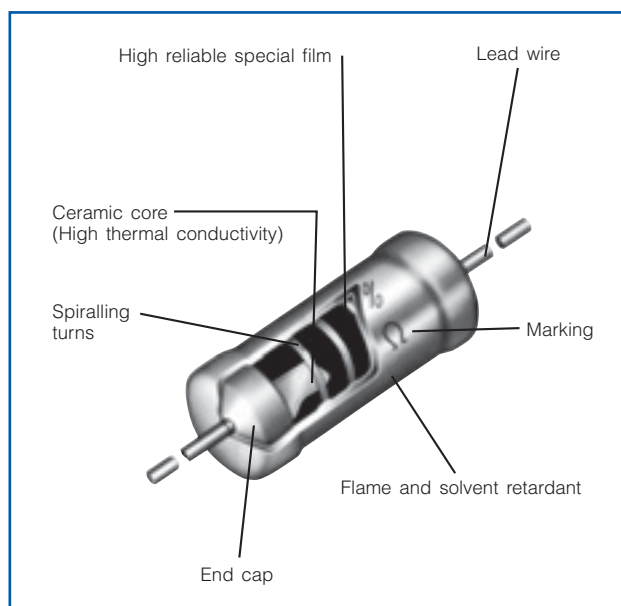

Dimensions in mm (not to scale)

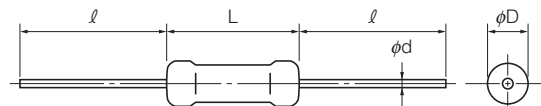

Part No.	Dimensions (mm)				Mass (Weight) [g/pc.]
	L	φD	ℓ	φd	
ERG12D	6.35 ^{+0.65} _{-0.35}	2.3 ^{+0.5} _{-0.3}	30.0 ^{±3.0}	0.65 ^{±0.05}	0.26
ERG1D	9.00 ^{+1.50} _{-1.00}	2.8 ^{±0.5}	30.0 ^{±3.0}	0.65 ^{±0.05}	0.33
ERG2D	12.00 ^{+1.50} _{-1.00}	4.0 ^{±1.0}	30.0 ^{±3.0}	0.80 ^{±0.05}	0.66
ERG3D	15.00 ^{±1.50}	5.5 ^{±1.0}	38.0 ^{±3.0}	0.80 ^{±0.05}	1.47

Design and specifications are each subject to change without notice. Ask factory for the current technical specifications before purchase and/or use. Should a safety concern arise regarding this product, please be sure to contact us immediately.

Ratings

Part No.	Power Rating at 70 °C (W)	Limiting Element Voltage ⁽¹⁾ (V)	Maximum Overload Voltage ⁽²⁾ (V)	Maximum Intermittent Overload Voltage ⁽³⁾ (V)	Dielectric Withstanding Voltage (VAC)	Res. Tol. (%)	Resistance Range (Ω) ⁽⁴⁾		Standard Resistance Value
							min.	max.	
ERG12D	0.5	400	800	800	500	J (±5) G (±2)	51 k	240 k	E24
ERG1D	1	500	1000	1000	500	J (±5) G (±2)	110 k	330 k	E24
ERG2D	2	500	1000	1000	700	J (±5) G (±2)	110 k	510 k	E24
ERG3D	3	500	1000	1000	700	J (±5) G (±2)	110 k	750 k	E24

(1) Rated Continuous Working Voltage (RCWW) shall be determined from $RCWW = \sqrt{\text{Power Rating} \times \text{Resistance Value}}$ or Limiting Element Voltage listed above whichever less.

(2) Overload (Short-time Overload) Test Voltage (SOTV) shall be determined from $SOTV = 2.5 \times \text{Power Rating}$ or max. Overload Voltage listed above whichever less.

(3) Intermittent Overload Test Voltage (IOTV) shall be determined from $IOTV = 4.0 \times \text{Power Rating}$ or max. Intermittent Overload Voltage listed above whichever less.

(4) Resistance tolerance and resistance range is of use besides range listed, please inquire.

Power Derating Curve

For resistors operated in ambient temperatures above 70 °C, power rating shall be derated in accordance with the figure on the right.

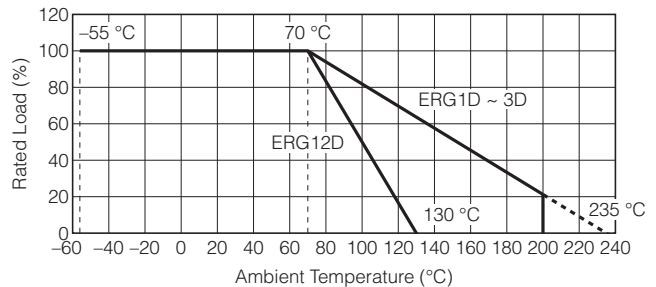

■ As for Packaging Methods and / or cut formed leads,

Please see Metal (Oxide) Film Resistors Packaging Methods

⚠ Safety Precautions

The following are precautions for individual products. Please also refer to the common precautions for Fixed Resistors in this catalog.

1. Transient voltage

If there is a possibility that the transient phenomenon (significantly high voltage applied in a short time) may occur or that a high voltage pulse may be applied, make sure to evaluate and check the characteristics of Anti-Pulse Power Resistors (hereafter called the resistors) mounted on your product rather than only depending on the calculated power limit or steady-state conditions to complete the design or decide to use the resistors.

- The resistors are covered with a special coating. Do not apply shock or vibration to them, or pinch them with long-nose pliers. Otherwise, the resistors may be damaged.
- Do not apply excessive tension to the lead-connected sections. When bending the lead wire, do not apply excessive stress to the resistors and provide the wire with a natural curvature.
- Do not brush the resistors during or after the cleaning process, which may be conducted after soldering. Otherwise, the coating film may be damaged.

Metal Film Resistors

Type: **ERXL (Low Resistance Value)**
(0.5 W, 1 W, 2 W)



Features

- Miniaturized
- Non-flammable
- Automatic Insertion
- RoHS compliant

Explanation of Part Numbers

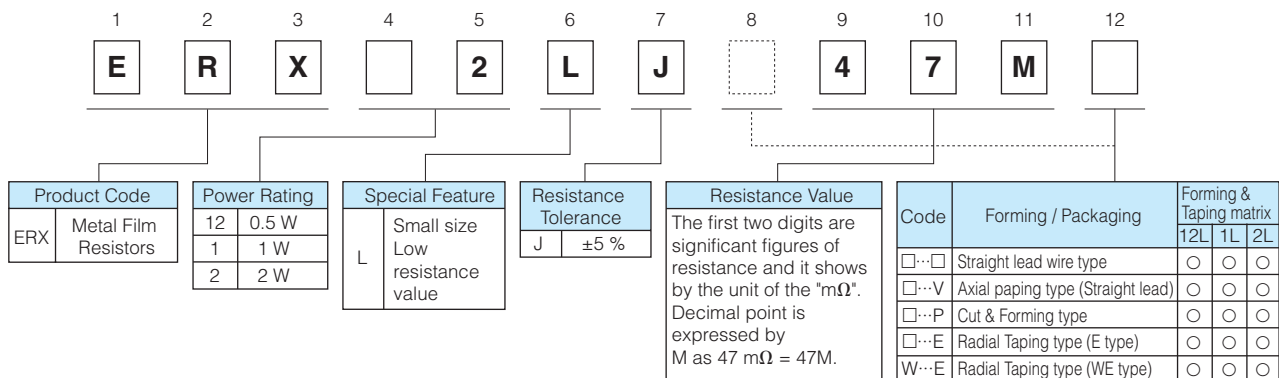

The above example shows a small size and low resistance value metal film resistor, 2 W power rating, resistance value of 47 m ohms, tolerance ±5 %, and package of standard bulk packing.

Construction

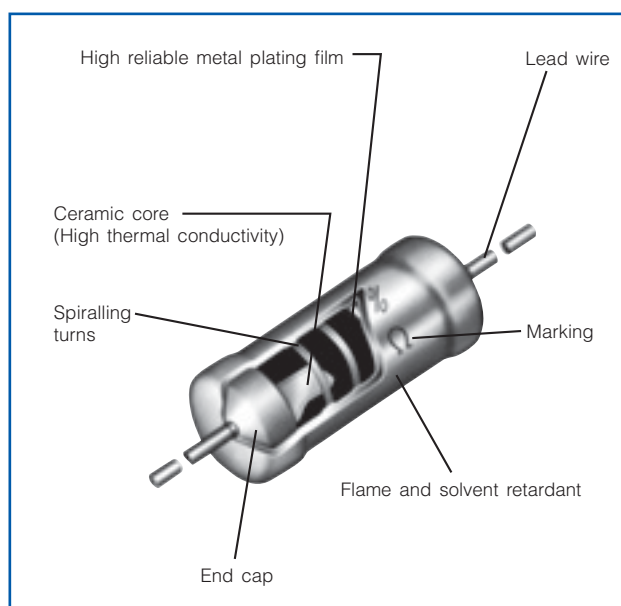

Dimensions in mm (not to scale)

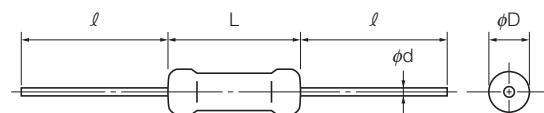

Part No.	Dimensions (mm)				Mass (Weight) [g/pc.]
	L	φD	l	φd	
ERX12L	6.35 ^{+0.65} _{-0.35}	2.3 ^{+0.5} _{-0.3}	30.0 ^{±3.0}	0.65 ^{±0.05}	0.26
ERX1L	9.00 ^{+1.50} _{-1.00}	2.8 ^{±0.5}	30.0 ^{±3.0}	0.65 ^{±0.05}	0.33
ERX2L	12.00 ^{+1.50} _{-1.00}	4.0 ^{±1.0}	30.0 ^{±3.0}	0.80 ^{±0.05}	0.66

Design and specifications are each subject to change without notice. Ask factory for the current technical specifications before purchase and/or use.
Should a safety concern arise regarding this product, please be sure to contact us immediately.

Ratings

Part No.	Power Rating at 70 °C ⁽¹⁾ (W)	Dielectric Withstanding Voltage (VAC)	Res. Tol. (%) ⁽²⁾	Resistance Range (Ω) ⁽²⁾		T.C.R. ($\times 10^{-6}/^{\circ}\text{C}$)	Standard Resistance Value
				min.	max.		
ERX12L	0.5	350	J (± 5)	22 m	82 m	22 to 39 mΩ=±1000 47 to 82 mΩ=± 500	E12
ERX1L	1	350	J (± 5)	22 m	82 m		E12
ERX2L	2	600	J (± 5)	22 m	82 m		E12

(1) Rated Continuous Working Voltage (RCWV) shall be determined from $\text{RCWV} = \sqrt{\text{Power Rating} \times \text{Resistance Value}}$.

(2) Resistance tolerance and resistance range is of use besides range listed, please inquire.

Power Derating Curve

For resistors operated in ambient temperatures above 70 °C, power rating shall be derated in accordance with the figure on the right.

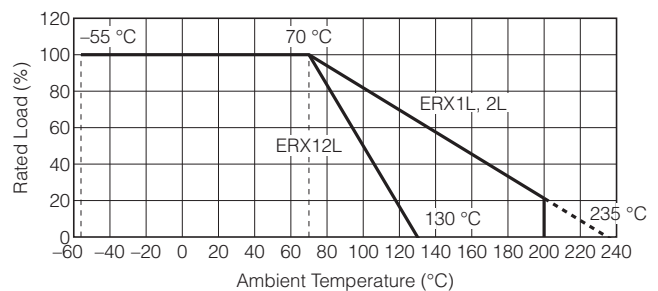

■ As for Packaging Methods and / or cut formed leads,

Please see Metal (Oxide) Film Resistors Packaging Methods

⚠ Safety Precautions

The following are precautions for individual products. Please also refer to the common precautions for Fixed Resistors in this catalog.

1. Transient voltage

If there is a possibility that the transient phenomenon (significantly high voltage applied in a short time) may occur or that a high voltage pulse may be applied, make sure to evaluate and check the characteristics of Metal Film Resistors (hereafter called the resistors) mounted on your product rather than only depending on the calculated power limit or steady-state conditions to complete the design or decide to use the resistors.

- The resistors are covered with a special coating. Do not apply shock or vibration to them, or pinch them with long-nose pliers. Otherwise, the resistors may be damaged.
- Do not apply excessive tension to the lead-connected sections. When bending the lead wire, do not apply excessive stress to the resistors and provide the wire with a natural curvature.
- Do not brush the resistors during or after the cleaning process, which may be conducted after soldering. Otherwise, the coating film may be damaged.

Metal Film Fusing Resistors

Type: **ERQA**
ERQZ
 (0.25 W, 0.5 W, 1 W, 2 W coating type)



Features

- Accurate fusing
- Small size and lightweight
- Uniform quality, consistent performance and reliability
- Flame retardant, utilizing exclusive silicon insulation material
- Reference Standard
EIAJ RC-2125
- RoHS compliant

Explanation of Part Numbers

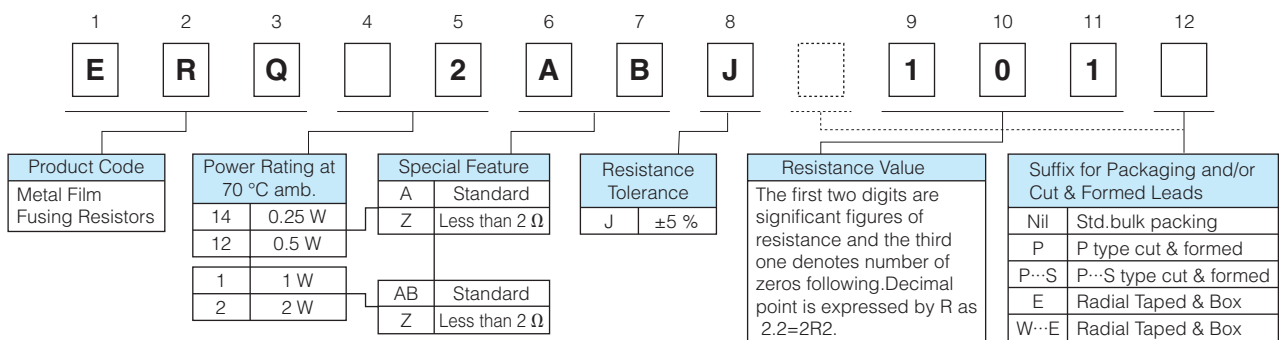

The above example shows a standard Metal Film Fusing Resistors, 2 W power rating, resistance value of 100 Ω, tolerance of ±5 %, and package of standard bulk packing.

Construction

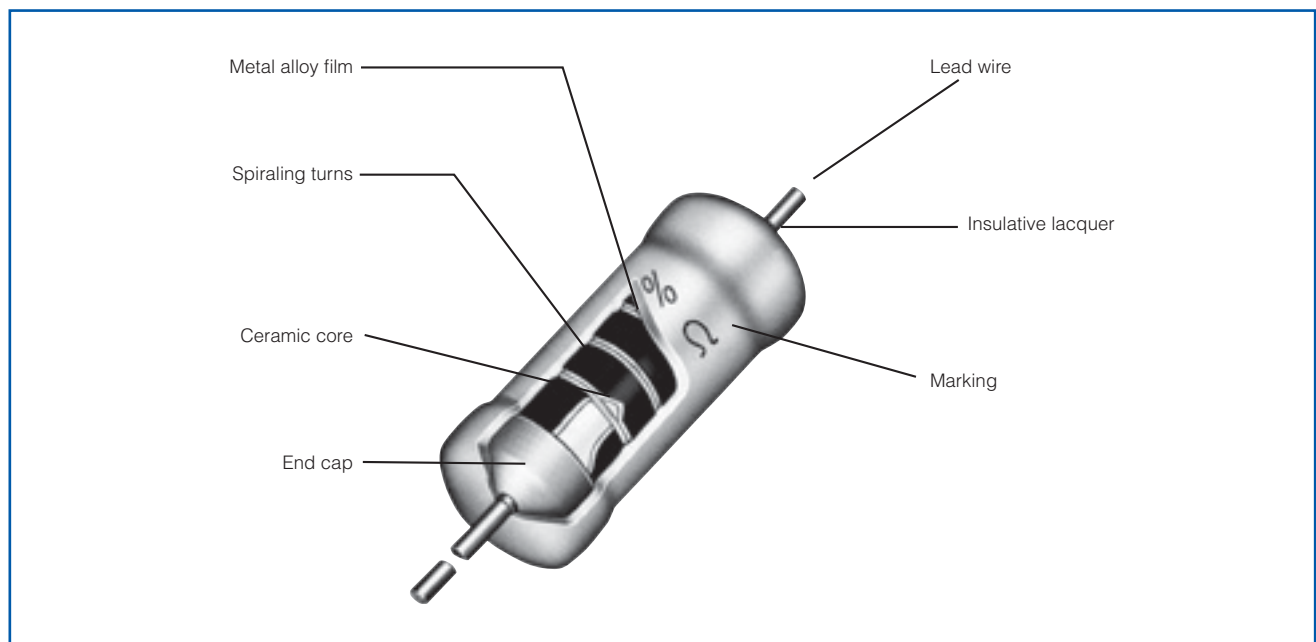

Ratings

Part No.	Power Rating at 70°C (W)	Maximum Open Circuit Voltage ⁽¹⁾ (V)	Maximum Overload Voltage	Dielectric With-standing Voltage (V)	Resistance Tolerance (%)	Resistance Range (Ω)		T.C.R. (× 10 ⁻⁶ /°C)	Standard Resistance Values	Marking Method on Body	Mass (Weight) [g/pc.]
						min.	max.				
ERQ14Z ERQ14A	0.25	200	3 times of rated voltage ⁽²⁾	AC 350	J (± 5)	1.0	1.8	±350	E24	Color code	0.24
2.0						470					
ERQ12Z ERQ12A	0.5	250		AC 350	J (± 5)	1.0	1.8	±350	E24	Stamp	0.32
2.0						560	Color code				
ERQ1Z ERQ1AB	1	250		AC 600	J (± 5)	1.0	1.8	±350	E24	Stamp	0.64
2.0						560					
ERQ2Z ERQ2AB	2	250	AC 1000	J (± 5)	1.0	1.8	±350	E24	Stamp	1.54	
2.0					560						

(1) Maximum Open Circuit Voltage: Referring to the maximum value of the voltage applied between terminals of the resistor when the resistor is opened in an electric circuit 1000 times power rating or voltage specified above whichever less is regarded as the maximum open circuit voltage.
 (2) Rated Continuous Working Voltage (RCWV) shall be determined from $RCWV = \sqrt{\text{Power Rating} \times \text{Resistance Value}}$

Power Derating Curve

For resistors operated in ambient temperatures above 70 °C, power rating shall be derated in accordance with the figure on the right.

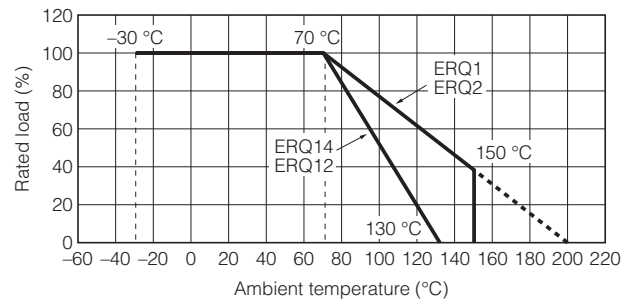

Performance Specifications

Characteristics	Specifications	Test Methods																
Fusing Characteristics	<table border="1"> <thead> <tr> <th>Rated Power</th> <th>Res. Value (Ω)</th> <th>Limit</th> </tr> </thead> <tbody> <tr> <td>0.25 W 0.5 W</td> <td rowspan="2">1 to 1.8</td> <td>Open within 30 seconds at 30 times the rated power</td> </tr> <tr> <td>1 W 2 W</td> <td>Open within 30 seconds at 25 times the rated power</td> </tr> <tr> <td>0.25 W 0.5 W 1 W 2 W</td> <td>2 to 9.1</td> <td>Open within 30 seconds at 16 times the rated power</td> </tr> <tr> <td>0.25 W</td> <td>10 to 470</td> <td rowspan="3">Open within 30 seconds at 12 times the rated power</td> </tr> <tr> <td>0.5 W 1 W 2 W</td> <td>10 to 560</td> </tr> </tbody> </table>	Rated Power	Res. Value (Ω)	Limit	0.25 W 0.5 W	1 to 1.8	Open within 30 seconds at 30 times the rated power	1 W 2 W	Open within 30 seconds at 25 times the rated power	0.25 W 0.5 W 1 W 2 W	2 to 9.1	Open within 30 seconds at 16 times the rated power	0.25 W	10 to 470	Open within 30 seconds at 12 times the rated power	0.5 W 1 W 2 W	10 to 560	<p>The test potential shall be preadjusted using a dummy resistor and then be subjected to the test specimens. The potential shall be readjusted within two seconds to reach the exact value of specified current. This test shall be made under the conditions at 20 °C and 65 % RH (or at a temperature of 5 °C to 35 °C and 45 to 85 % RH, only when any doubt may not be caused), and the use of stabilized power source is suggested. Fusing time shall be measured as the duration until the circuit current is decreased to a 1/50 the initial test current or less.</p>
	Rated Power	Res. Value (Ω)	Limit															
	0.25 W 0.5 W	1 to 1.8	Open within 30 seconds at 30 times the rated power															
	1 W 2 W		Open within 30 seconds at 25 times the rated power															
	0.25 W 0.5 W 1 W 2 W	2 to 9.1	Open within 30 seconds at 16 times the rated power															
0.25 W	10 to 470	Open within 30 seconds at 12 times the rated power																
0.5 W 1 W 2 W	10 to 560																	

Dimensions in mm (not to scale)

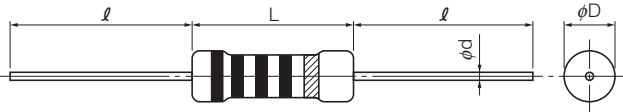

Part No.	Dimensions (mm)			
	L	φD	l	φd
ERQ14	6.3 ^{+1.5} _{-1.0}	2.3 ^{±0.5}	30.0 ^{±3.0}	0.65 ^{±0.05}
ERQ12	9.0 ^{+1.5} _{-1.0}	2.8 ^{±0.5}	30.0 ^{±3.0}	0.65 ^{±0.05}
ERQ1	12.0 ^{+1.5} _{-1.0}	4.0 ^{±1.0}	30.0 ^{±3.0}	0.80 ^{±0.05}
ERQ2	15.0 ^{±1.5}	5.5 ^{±1.0}	38.0 ^{±3.0}	0.80 ^{±0.05}

Explanation of Marking

Type ERQ14, ERQ12 (0.25 W, 0.5 W)

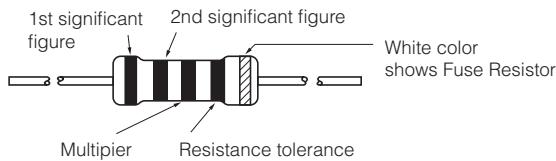

Type ERQ1, ERQ2 (1W, 2W)

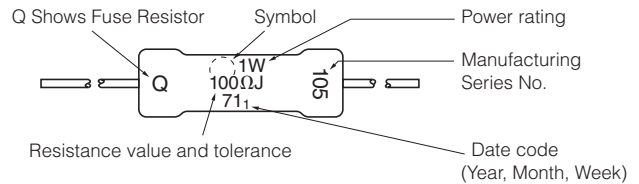

Cut & Formed Type

ERQ□□AJ□□□P
ERQ□□ZJ□□□P

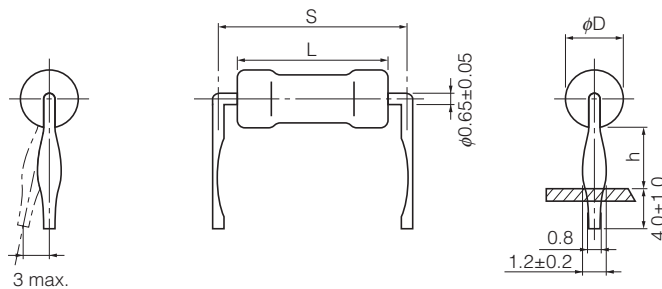

Part No.	Power Rating at 70 °C (W)	Standard Q'ty/Packing (pcs.)	Dimensions (mm)			
			L	φD	S	h
ERQ14□J□□□P	0.25	2,000	6.3 ^{+1.5} _{-1.0}	2.3 ^{±0.5}	10.0 ^{±1.5}	4.0 ^{±1.5}
ERQ12□J□□□P	0.5	2,000	9.0 ^{+1.5} _{-1.0}	2.8 ^{±0.5}	12.5 ^{±1.5}	4.0 ^{±1.5}

ERQ□ABJP□□□S
ERQ□ZJP□□□S

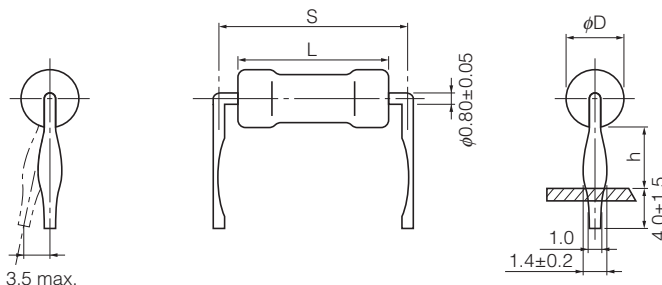

Part No.	Power Rating at 70 °C (W)	Standard Q'ty/Packing (pcs.)	Dimensions (mm)			
			L	φD	S	h
ERQ1□□JP□□□S	1	1,000	12.0 ^{+1.5} _{-1.0}	4.0 ^{±1.0}	15.0 ^{±1.5}	6.0 ^{±1.5}
ERQ2□□JP□□□S	2	1,000	15.0 ^{±1.5}	5.5 ^{±1.0}	20.0 ^{±2.0}	6.5 ^{±1.5}

Design and specifications are each subject to change without notice. Ask factory for the current technical specifications before purchase and/or use. Should a safety concern arise regarding this product, please be sure to contact us immediately.

For Panasert Automatic Insertion Machine Radial Taped & Box

ERQ□□AJ□□□□E
ERQ□□ZJ□□□□E
(14A/14Z, 12A/12Z, 1AB/1Z)

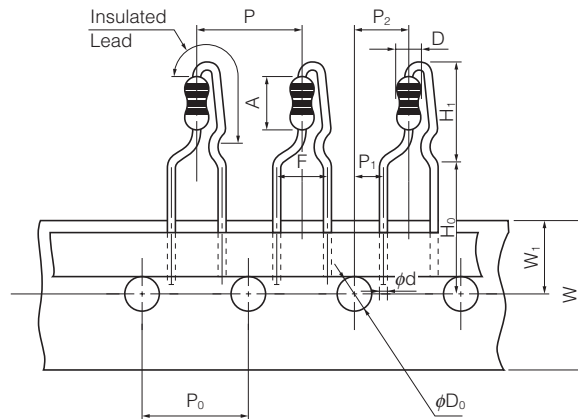

Dimensions (mm)		Dimensions (mm)		Dimensions (mm)		Dimensions (mm)		Dimensions (mm)				
P	12.7±1.0	W	18.0±0.5	H ₁	14A/14Z	12 max.	A	14A/14Z	6.35 ^{+0.65} _{-0.35}	D	14A/14Z	2.3±0.5
P ₀	12.7±0.3	W ₁	9.0±0.5		12A/12Z	15.5 max.		12A/12Z	9.0 ^{+1.5} _{-1.0}		12A/12Z	2.8±0.5
P ₁	3.85±0.70				1AB/1Z	19 max.		1AB/1Z	12.0 ^{+1.5} _{-1.0}		1AB/1Z	4.0±1.0
P ₂	6.35±1.00			H ₀	16.0±0.5		phi d	0.65±0.05				
F	5.0±0.8			phi D ₀	4.0±0.2							

● Radial Tape Packaging Methods

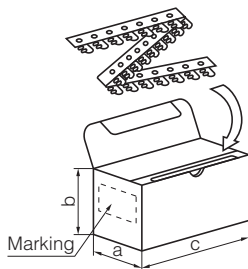

Part Number	Dimensions (mm)			Standard Quantity (pcs./box)
	a	b	c	
ERQ14AJ□□□□E ERQ14ZJ□□□□E	46	130	335	2,000 pcs./box
ERQ12AJ□□□□E ERQ12ZJ□□□□E	46	130	335	2,000 pcs./box
ERQ1ABJ□□□□E ERQ1ZJ□□□□E	49	100	335	1,000 pcs./box

For Panasert Automatic Insertion Machine Radial Taped & Box

ERQ□□A/ZJW□□□□E (14A/14Z, 12A/12Z, 1AB/1Z)

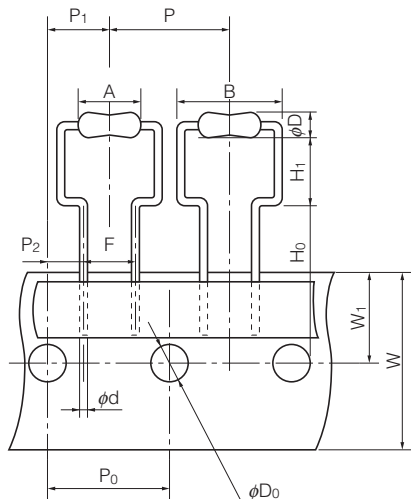

Dimensions (mm)			Dimensions (mm)		
P	14A/14Z	12.7±1.0	H ₁	14A/14Z	6.5 ^{+0.6} _{-0.6}
	12A/12Z, 1AB/1Z	30.0±1.0		12A/12Z	6.5 ^{+1.0} _{-1.0}
P ₀	14A/14Z	12.7±0.3		1AB/1Z	6.5 ^{+1.0} _{-1.0}
	12A/12Z, 1AB/1Z	15.0±0.3	phi D ₀	4.0±0.2	
P ₁	14A/14Z	6.35±1.00	A	14A/14Z	6.35 ^{+0.65} _{-0.35}
	12A/12Z, 1AB/1Z	7.5±1.0		12A/12Z	9.0 ^{+1.5} _{-1.0}
P ₂	14A/14Z	3.85±0.70		1AB/1Z	12.0 ^{+1.5} _{-1.0}
	12A/12Z, 1AB/1Z	3.75±0.50	B	14A/14Z	11.2 max.
F	14A/14Z	5.0 ^{+0.6} _{-0.2}		12A/12Z	14 max.
	12A/12Z, 1AB/1Z	7.5 ^{+0.6} _{-0.2}	1AB/1Z	17 max.	
W	18.0±0.5		phi D	14A/14Z	2.3 ^{+0.5} _{-0.3}
W ₁	9.0±0.5			12A/12Z	2.8±0.5
H ₀	14A/14Z	16.0±0.5	phi d	1AB/1Z	4.0±1.0
	12A/12Z	18.0±1.0		14A/14Z	0.65±0.05
	1AB/1Z	18.0±1.0		12A/12Z, 1AB/1Z	0.80±0.05

Fusing Characteristics (Constant Voltage Circuit)

This data is for reference only, specifications should be verified in written form with the engineering division.

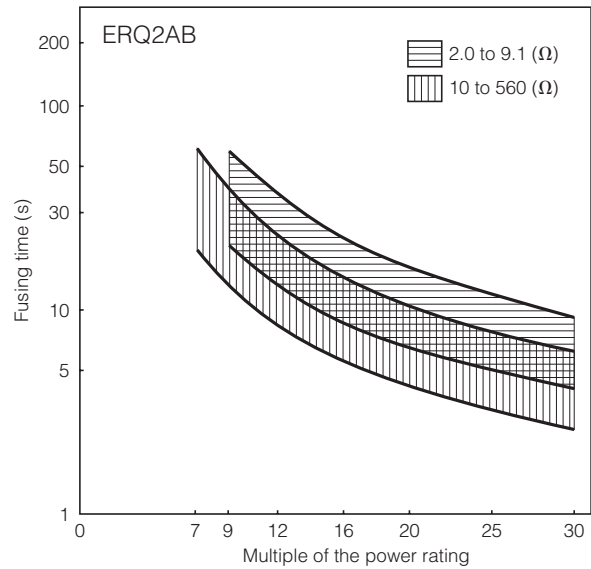
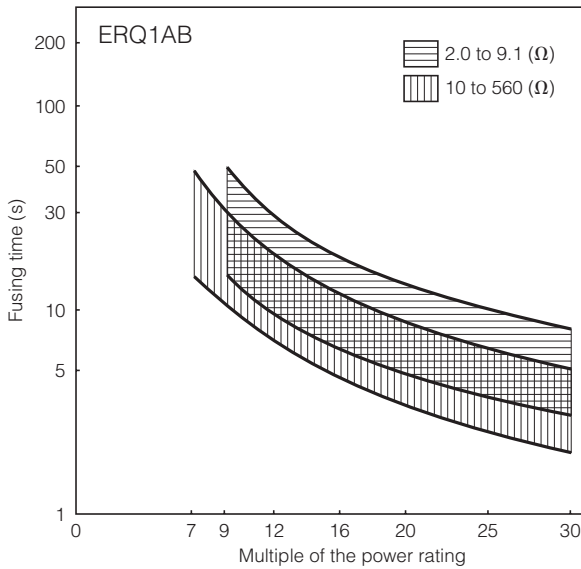
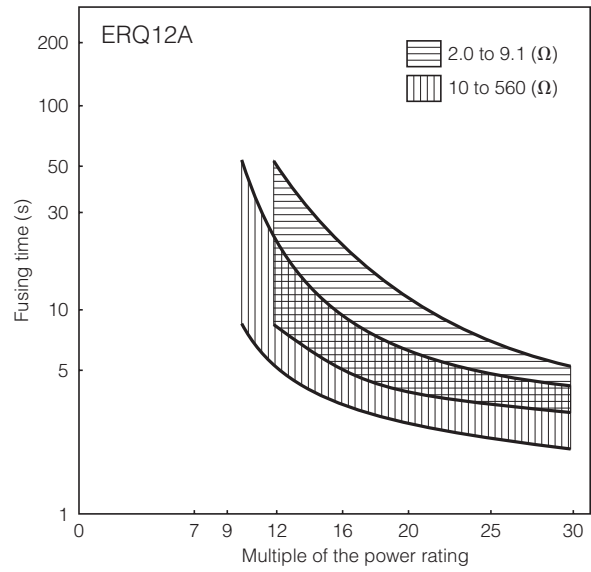
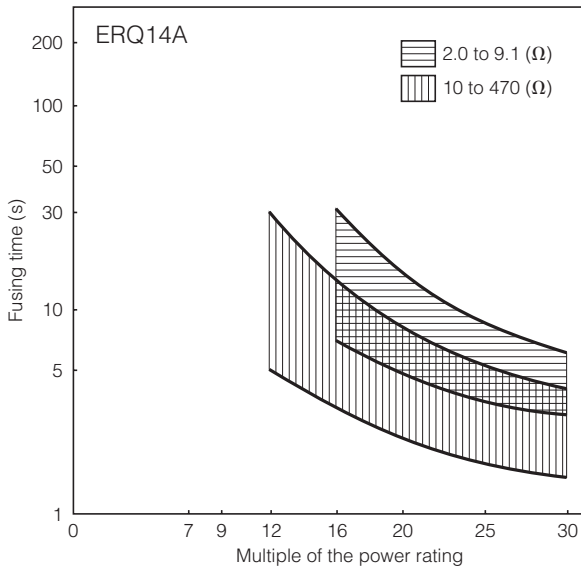

Hot Spot Temperature (for reference)

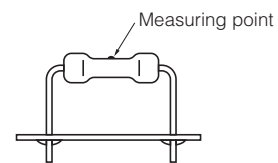
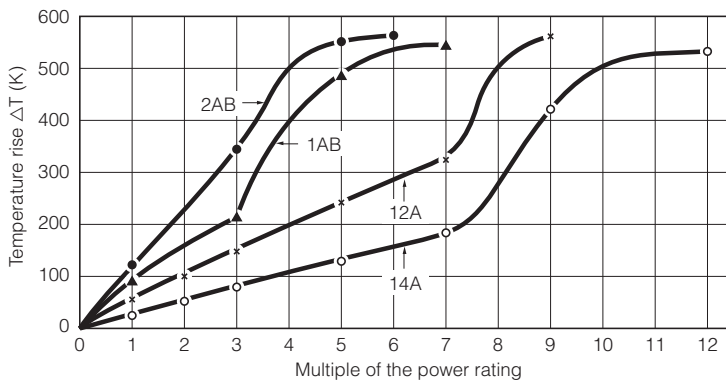

⚠ Safety Precautions

The following are precautions for individual products. Please also refer to the common precautions for Fixed Resistors in this catalog.

1. Checking the fusing conditions
 - 1) Fusing characteristics differ depending on the type, shape, and resistance. Check the fusing conditions before selecting the type of Metal Film Fusing Resistors (hereafter called the fusing resistor) to be used.
 - 2) Use the fusing resistors under the maximum open circuit voltage. Otherwise, arcing may occur when a voltage much higher than the rated one is applied in the event of an abnormality in the circuit, or when a high voltage is applied after fusing.
 - 3) Under abnormal conditions of a constant voltage circuit, a current of about 2 or 3 times the initial abnormal current passes through, accelerating the speed at which the fusing resistors blows. When using a constant current circuit, carefully check the conditions because the fusing resistors may not blow in a constant current circuit.
2. Checking for pulse voltage, impact voltage, and transient voltage

Make sure to evaluate and check the fusing resistors mounted on your product if they are to be mounted on a circuit that generates an impact voltage, or if there is a possibility that the transient phenomenon (significantly high voltage applied in a short time) may occur or that a pulse voltage with a high peak voltage may be applied. Make sure to consult our sales staff before using the fusing resistors under special conditions.
3. Conditions of use in a steady state

Make sure that the load conditions have a sufficient allowance for the power derating curve. The characteristics of the fusing resistors are set by using a constant voltage circuit.
4. The solvent resistance of the fusing resistors is not assured. If you use a solvent for cleaning after soldering or other processes, make sure to consult our sales staff before use and perform a prior test and evaluation to ensure that the solvent will not affect the reliability of the fusing resistors.

(Data for Reference)

Pulse Characteristics (Usual)

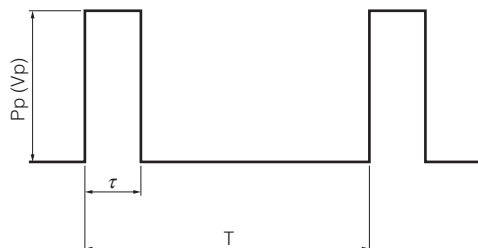

- P_P : Pulse limit power (W)
- V_P : Pulse limit voltage (V)
- τ : Pulse continuous time (s)
- T : Period (s)
- V_R : Rated voltage (V)
- P : Rated power (W)
- R : Resistance value (Ω)
- $V_{pmax.}$: Max. pulse limit voltage (V)

Withstand pulse limit power is calculated by the next method.

$$P_P = K \cdot P \cdot T/\tau$$

$$V_P = \sqrt{K \cdot P \cdot R \cdot T/\tau}$$

Reference to the right about a fixed number of $V_{pmax.}$

Part No.	K	$V_{pmax.}$ (V)
ERQ14A	0.6	200
ERQ12A	0.6	250
ERQ1AB	0.6	250
ERQ2AB	0.4	250

- $T > 1(s) \rightarrow T = 1(s)$
- $T/\tau > 100 \rightarrow T/\tau = 100$
- $P_P < P \rightarrow P$ stands for P_P
($V_P < V_R \rightarrow V_R$ stands for V_P)
- Added voltage $\leq V_{pmax.}$
- P_P or V_P is reference value
Conditions : Pulse added time=1000 h, Resistance change= $\pm 5\%$
Room temperature

Standard for Resistance Value, Resistance Tolerance and Color Code

Basis Standard

IEC Publication 60062 : Marking codes for resistors and capacitors.
 IEC Publication 60063 : Preferred number series for resistors and capacitors.
 JIS C 5062 : Marking codes for resistors and capacitors.
 JIS C 5063 : Preferred number series for resistors and capacitors.

Resistance Values

The resistance values are notched by "Ratio" below in each series.

Series	Resistance Tolerance (Standard)	Ratio	Remarks
E6	±20 %	$\sqrt[6]{10} \approx 1.46$	Please refer to standard resistance values shown on this catalog.
E12	±10 %	$\sqrt[12]{10} \approx 1.21$	
E24	± 5 %	$\sqrt[24]{10} \approx 1.10$	
E48	± 2 %	$\sqrt[48]{10} \approx 1.05$	
E96	± 1 %	$\sqrt[96]{10} \approx 1.02$	

How to express the resistance value with a Panasonic part number

The resistance value expressed in ohms is identified by a three digit number or a four digit number.
 The last digit specifies the number of zeroes to follow.
 The letter "R" shall be used as the decimal point for less than 10 Ω.

The examples of a three digit number

Resistance Code	Value in ohms
R56	0.56
5R6	5.6
100	10
271	270
102	1 k
273	27 k
104	100 k
275	2.7 M
106	10 M
107	100 M

The examples of a four digit number

Resistance Code	Value in ohms
R562	0.562
5R62	5.62
56R2	56.2
1000	100
2711	2.71 k
1002	10 k
2713	271 k
1004	1 M
2715	27.1 M
1006	100 M

How to express the resistance tolerance with a Panasonic part number

The resistance tolerance is identified by a single letter in accordance with the following table and the code is placed just before the resistance code in the following examples.

Tolerance Code	Tolerance (%)	Examples
W	±0.05	W1001 : 1000 Ω±0.05 %
B	±0.1	B1001 : 1000 Ω±0.1 %
C	±0.25	C1001 : 1000 Ω±0.25 %
D	±0.5	D1001 : 1000 Ω±0.5 %
F	±1	F1001 : 1000 Ω±1 %
G	±2	G1001 : 1000 Ω±2 %
J	±5	J101 : 100 Ω±5 %
K	±10	K101 : 100 Ω±10 %
M	±20	M101 : 100 Ω±20 %

Color code indication for the resistance value and the tolerance

Fixed resistors whose resistance value and tolerance are indicated by color code follow the standard below.

Color code

Color	First digit	Second digit	Third digit	Multiplier	Resistance tolerance	
					%	Code
Black	0	0	0	1		
Brown	1	1	1	10	±1	F
Red	2	2	2	10 ²	±2	G
Orange	3	3	3	10 ³	±0.05	W
Yellow	4	4	4	10 ⁴		
Green	5	5	5	10 ⁵	±0.5	D
Blue	6	6	6	10 ⁶	±0.25	C
Violet	7	7	7	10 ⁷	±0.1	B
Gray	8	8	8			
White	9	9	9			
Gold				10 ⁻¹	±5	J
Silver				10 ⁻²	±10	K
None					±20	M

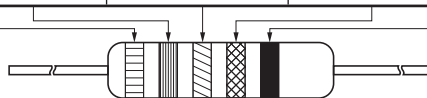

Indication example

Color code of 5 color bands

When the standard resistance value follows E48 series or 96 series, color code of the resistors are indicated by five color bands. Example below is 154 kΩ.

Example 1

1st Color	2nd Color	3rd Color	4th Color	5th Color
Brown (1)	Green (5)	Yellow (4)	Orange (1000)	Brown (±1 %)

Color code of 4 color bands

When the standard resistance value follows E6 series, 12 series or 24 series, color code of the resistors are indicated by four color bands. Example below is 15 kΩ.

Example 2

1st Color	2nd Color	3rd Color	4th Color
Brown (1)	Green (5)	Orange (1000)	Gold (±5 %)

Standard Resistance Values

E6	E12	E24	E48	E96	E6	E12	E24	E48	E96	E6	E12	E24	E48	E96
10	10	10	100	100				215	215				464	464
			102		22	22	22		221			47		475
			105	105				226	226				487	487
			107						232					499
		11	110	110				237	237			51	511	511
			113				24		243					523
			115	115				249	249				536	536
			118						255					549
	12	12	121	121				261	261		56	56	562	562
			124						267					576
			127	127		27	27	274	274				590	590
		13		130					280					604
			133	133				287	287			62	619	619
			137						294					634
			140	140			30	301	301				649	649
			143						309					665
			147	147				316	316		68	68	681	681
			150						324					698
15	15	15		154	154	33	33	33	332	332			715	715
				158					340					732
		16	162	162				348	348			75	750	750
			165						357					768
			169	169			36	365	365				787	787
			174						374					806
			178	178				383	383		82	82	825	825
	18	18		182		39	39		392					845
			187	187				402	402				866	866
			191						412					887
			196	196				422	422			91	909	909
		20		200			43		432					931
			205	205				442	442				953	953
			210						453					976

Design and specifications are each subject to change without notice. Ask factory for the current technical specifications before purchase and/or use.
Should a safety concern arise regarding this product, please be sure to contact us immediately.

CAUTION AND WARNING

1. The electronic components contained in this catalog are designed and produced for use in home electric appliances, office equipment, information equipment, communications equipment, and other general purpose electronic devices.
Before use of any of these components for equipment that requires a high degree of safety, such as medical instruments, aerospace equipment, disaster-prevention equipment, security equipment, vehicles (automobile, train, vessel), please be sure to contact our sales representative.
2. When applying one of these components for equipment requiring a high degree of safety, no matter what sort of application it might be, be sure to install a protective circuit or redundancy arrangement to enhance the safety of your equipment. In addition, please carry out the safety test on your own responsibility.
3. When using our products, no matter what sort of equipment they might be used for, be sure to make a written agreement on the specifications with us in advance.
4. Technical information contained in this catalog is intended to convey examples of typical performances and/or applications and is not intended to make any warranty with respect to the intellectual property rights or any other related rights of our company or any third parties nor grant any license under such rights.
5. In order to export products in this catalog, the exporter may be subject to the export license requirement under the Foreign Exchange and Foreign Trade Law of Japan.
6. No ozone-depleting substances (ODSs) under the Montreal Protocol are used in the manufacturing processes of Automotive & Industrial Systems Company, Panasonic Corporation.

● Please contact _____

● Factory _____

Circuit Components Business Division
Automotive & Industrial Systems Company
Panasonic Corporation
401 Sadamasa-cho, Fukui-shi,
Fukui 910-8502, JAPAN

The information in this catalog is valid as of December 2014.