

■ Embedded Power for  
Business-Critical Continuity™

## *Embedded Power AC-DC and DC-DC Power Conversion Solutions*



**C O D I C O**®

Zwingenstrasse 6-8, A-2380 Perchtoldsdorf  
Tel. Vienna +43/(0)1/86 305 - 5000  
Fax Vienna +43/(0)1/86 305 - 98  
e-mail: [office@codico.com](mailto:office@codico.com)  
[www.codico.com](http://www.codico.com)

  
**EMERSON**™  
Network Power



# Contents

## AC–DC Power Supplies

|  |    |
|--|----|
| <b>Low Power 3-500 W</b>                           |    |
| ■ Open frame/enclosed 1-4 outputs                  | 10 |
| ■ Convection/conduction mounting                   | 15 |
| ■ External power adapters                          | 17 |
| <b>Healthcare Power Up to 4920 W</b>               |    |
| ■ 1-24 outputs                                     | 20 |
| <b>LED Drivers</b>                                 |    |
| ■ LED Lighting Drivers                             | 24 |
| <b>Micro Medium Power (μMP) Up to 1200 W</b>       |    |
| ■ Up to 12 outputs                                 | 25 |
| <b>Medium Power (MP) Up to 1200 W</b>              |    |
| ■ 1-10 outputs standard (up to 21 available)       | 27 |
| <b>Intelligent Medium Power (iMP) Up to 1500 W</b> |    |
| ■ Up to 21 outputs                                 | 29 |
| <b>Intelligent High Power (iVS) Up to 4920 W</b>   |    |
| ■ Up to 24 outputs                                 | 32 |
| <b>Bulk Power 310-12000 W</b>                      |    |
| ■ Bulk front end                                   | 35 |
| ■ Distributed power bulk front end                 | 41 |
| <b>Distributed Power (DS) 450-2900 W</b>           |    |
| ■ Available 1U, 2U and 3U                          | 44 |
| <b>DIN Rail (ADN) 24 V 120-960 W</b>               |    |
| ■ Single & 3-phase                                 | 50 |

## DC–DC Converters

|   |    |
|---|----|
| <b>Industry Standard Isolated</b>         |    |
| ■ Sixteenth-Brick                         | 54 |
| ■ Eighth-Brick                            | 55 |
| ■ Quarter-Brick                           | 57 |
| ■ Half-Brick                              | 59 |
| ■ RF Power Brick                          | 60 |
| <b>Industry Standard Non-Isolated</b>     |    |
| ■ C-Class                                 | 61 |
| ■ E-Class                                 | 63 |
| ■ F-Class                                 | 64 |
| ■ POLA Products                           | 65 |
| ■ VRM Processor Power                     | 66 |
| <b>High Power 300 V Input</b>             |    |
| ■ On-board AC–DC Distributed Architecture | 67 |
| ■ Power Factor Correction (PFC)           | 68 |
| <b>Low Power Industrial</b>               |    |
| ■ Low Power Isolated DC-DC Product        | 69 |
| Terms and Conditions                      | 73 |
| Index                                     | 75 |

For additional information go to  
[www.Emerson.com/EmbeddedPower](http://www.Emerson.com/EmbeddedPower)



The Embedded Power business of Emerson Network Power offers thousands of standard, modified standards and custom power supply products. Every standard product in our extensive portfolio is designed to help speed time-to-market more cost effectively and with less risk – with an outstanding level of support.

Our research, development, sales and support teams throughout the world are dedicated to meeting your needs today and in the future with innovative power solutions. We have invested in state-of-the-art manufacturing facilities and advanced global distribution systems to quickly manufacture and deliver the power products you need. We can quickly respond to your changing demands and have the ability to support you locally or worldwide.

Uniting the well-known Astec and Artesyn brands, the combined strength and experience of these companies, fused with pedigrees of quality, innovation and a deep understanding of our customers' needs, positions Emerson Network Power for continued growth and leadership in the embedded power markets.

This catalog lists key performance data for all standard ac-dc power supplies and dc-dc converters from the Embedded Power business of Emerson Network Power. It is designed to provide you with a fast, easy-to-use means of identifying the ideal power source for your application.

After selecting the product that you need from this catalog, we recommend that you visit our website to obtain more detailed information. You will find that you can quickly download product datasheets and safety certificates, check stock levels at our extensive global distribution network, and request evaluation samples. You can even ask one of our experts for technical advice, or register for the 'MyPower' community portal to gain access to tools, a knowledge base and support to help guide you to the best power solution for your needs.

## Local Support

*Our regional sales offices are ready to provide expert local applications and sales support. In addition, an extensive network of manufacturers' representatives and distributors bring our products to you. Please call for locations of sales offices near you or visit our website at [Emerson.com/EmbeddedPower](http://Emerson.com/EmbeddedPower).*

### Americas (USA)

Telephone: +1 760 930 4600  
Facsimile: +1 760 930 0698

### Europe (UK)

Telephone: +44 (0) 1384 842 211  
Facsimile: +44 (0) 1384 843 355

### Asia (HK)

Telephone: +852 2176 3333  
Facsimile: +852 2176 3888

## Technical Support

### Americas (USA)

+1 888 412 7832 (North America)

### Europe, Middle East and Africa (EMEA)

0 800 0321546 (in the UK)  
+44 800 0321546 (outside the UK)

### Asia

+400 88 99 130 (China)  
+86 29 8883 6505 (outside China)

### Email:

Americas and EMEA  
[techsupport.embeddedpower@emerson.com](mailto:techsupport.embeddedpower@emerson.com)

### Asia

[TSXA.embeddedpower@emerson.com](mailto:TSXA.embeddedpower@emerson.com)



Zwingenstrasse 6-8, A-2380 Perchtoldsdorf  
Tel. Vienna +43/(0)1/86 305 - 5000  
Fax Vienna +43/(0)1/86 305 - 98  
e-mail: [office@codico.com](mailto:office@codico.com)  
[www.codico.com](http://www.codico.com)

# Embedded Power Selector Guide

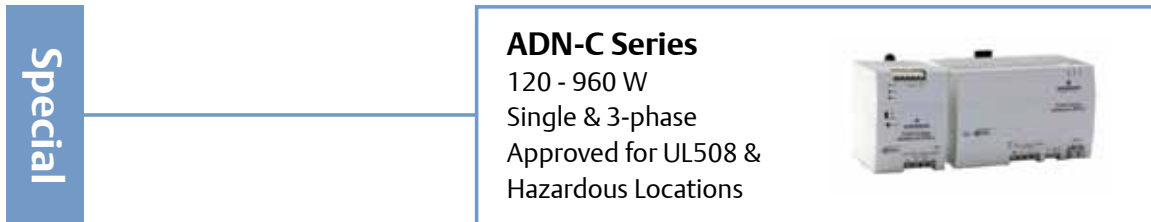
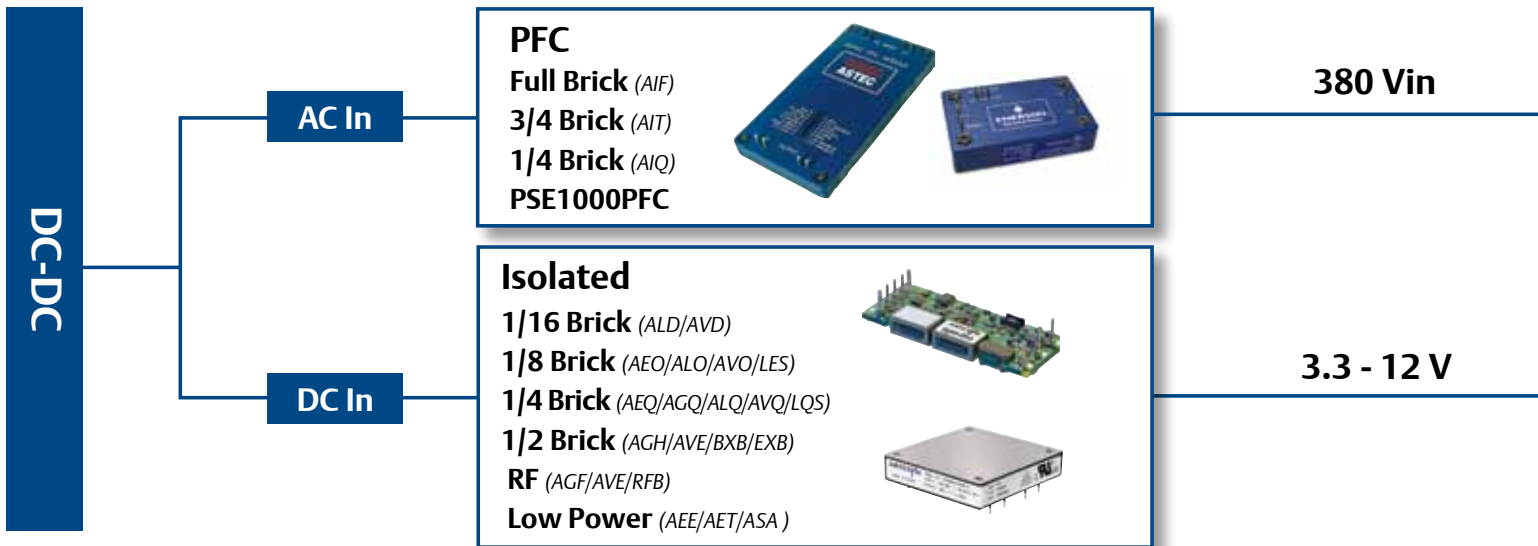
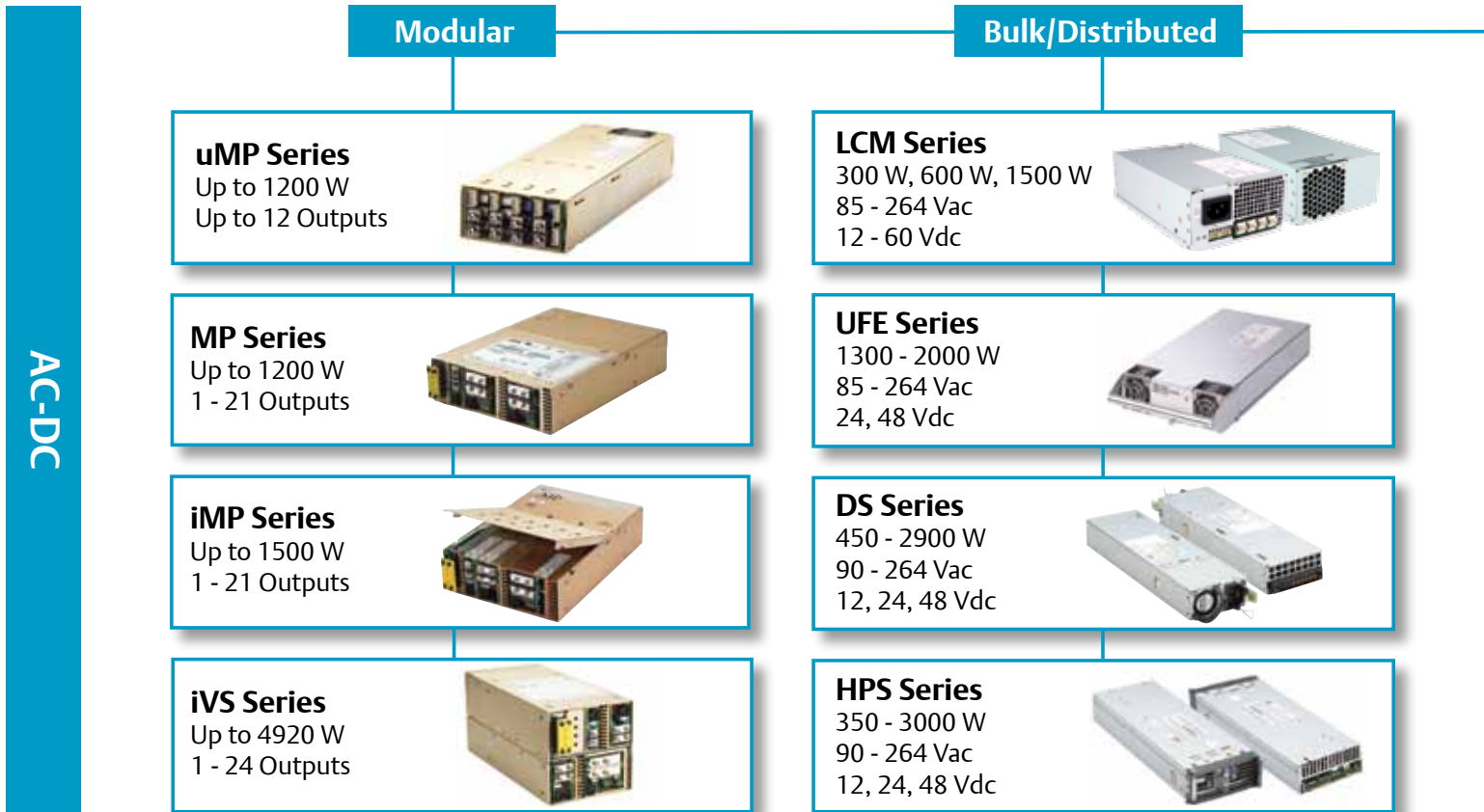

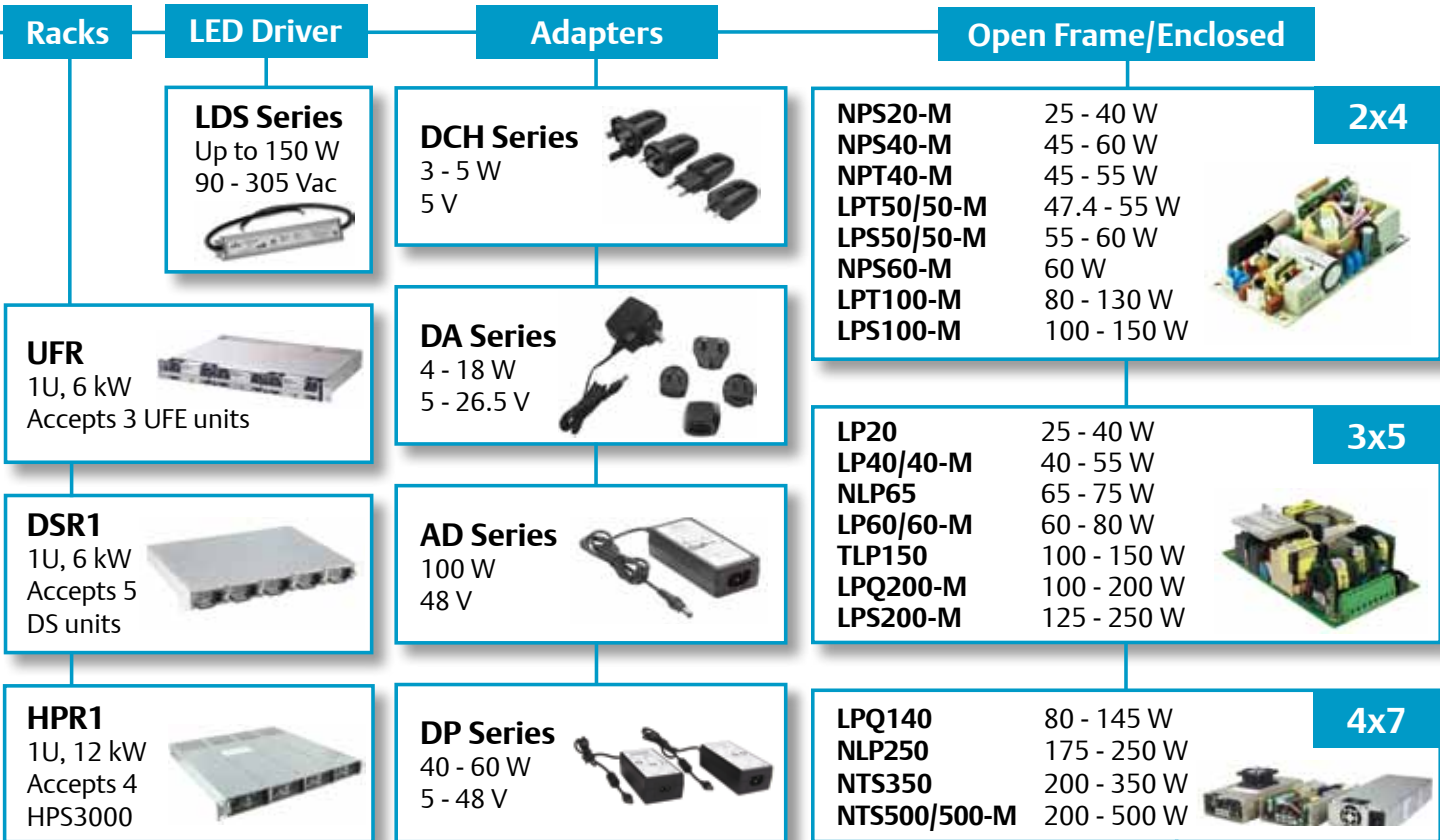

**Fanless/Conduction Cooled**

**LCC250** 150 - 250 W **4x7**



**High Power**  
Full Brick (AIF)  
3/4 Brick (AIT)  
1/2 Brick (AIH)  
1/4 Brick (AIQ)  
PSE 1000 DC-12



**Non-Isolated**  
C-Class (LDO, LGA, SIL, SMT)  
E-Class (APA, APC, SIL, SMT)  
F-Class (SMT)  
POLA (PTH, PTV)

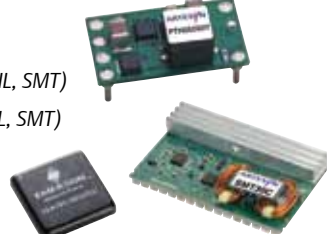

**VRM**  
149 W  
80 - 105 A  
0.8 - 1.9 V



|              |        |
|--------------|--------|
| <b>Logic</b> | > 24 V |
|              | 24.0 V |
|              | 12.0 V |
|              | 5.0 V  |
|              | 3.3 V  |
|              | 2.5 V  |
|              | 1.8 V  |
|              | 1.5 V  |
|              | 1.2 V  |
|              | 0.9 V  |

**Output Current: Up to 100 A**

For more information and a complete overview of Embedded Power products and services go to [www.Emerson.com/EmbeddedPower](http://www.Emerson.com/EmbeddedPower)



For additional information go to  
[www.Emerson.com/EmbeddedPower](http://www.Emerson.com/EmbeddedPower)



## Accelerate, Improve & Enhance the Capabilities of Your Next System Design

*At Emerson Network Power, our engineers have been designing and developing power supply products for over 35 years. Our products have helped pave the way for advancements in numerous applications in the communications, industrial, computing, data storage and healthcare markets.*

When developing products, time is money. Every step in the process that you can eliminate, speed up, or make more effective accelerates your time-to-market and lowers your R&D costs. Major advantages of partnering with Emerson Network Power include:

- Broadest power supply product lines
- Highly versatile power supplies
- Modified standards and value-add services
- Low energy consumption
- Eco-friendly products
- Space-efficient power
- Reliability & quality
- Worldwide distributor network
- Vast knowledge, experience & expertise

### **Innovation for the Next Generation**

Many of our products incorporate powerful programming, monitoring and self-testing software providing system engineers with critical data to manage power consumption. High efficiency, green design and manufacturing technologies, and innovative demand and supply replenishment systems collectively deliver key business efficiencies and new design capabilities. Emerson Network Power can help take your new product design or redevelopment efforts to the next level with a shorter time-to-profit, higher reliability and greater scalability. Emerson benefits include:

- **Shorter Time-to-Market** – our latest programmable power solutions and our modular, medium/high power  $\mu$ MP and iMP series provide you with shorter time-to-market and offer faster test and qualification than traditional analog power solutions. Our modified standards and value-add services also provide turn-key solutions for the best application match to help accelerate time-to-market without compromising quality.
- **Higher Reliability** – moving from inflexible fixed-output analog power supplies to programmable power solutions enables our engineers to more extensively test and document our products to ensure they meet or exceed your reliability requirements. And we provide a wide range of on-line environmental, EMC compliance and safety certification to help speed your product design process.
- **Greater Scalability** – many of our latest power solutions are scalable, programmable and plug-compatible with our earlier-generation products, enabling you to quickly address changes or enhancements to your systems. You can now satisfy most changes in power requirements simply by reprogramming the power supply – and if your needs change radically, you can easily swap to a more capable solution. This inherent scalability eliminates redesign costs, reduces testing time and provides you with greater design flexibility.



## Power Supply Design Controls

*Emerson utilizes the following design methodologies and techniques to ensure that our power supplies meet the rigorous quality & reliability requirements of the communications, industrial, computing, data storage and healthcare markets.*

### Reliability Models and Predictions

- A prediction of design reliability in terms of Mean Time Between Failures (MTBF) using Telecordia, Bellcore or MIL-HDBK-217F
- Not intended as a measure of expected field performance, but for design trade-off analysis and review of part stress derating performance

### Failure Modes and Effect Analysis

- An analytical technique to identify and review failure modes, their causes, mechanisms and effects
- Provides a formal risk assessment to reduce field failures at the customer site

### Component Selection

- Database warehouse of all component information
- Design engineers can only select components rigorously approved from suppliers that have undergone strict qualification and auditing process

### Derating Analysis

- Intended to reduce the failure rate of components

### Design for Manufacturability

- Design rules regarding manufacturability

### Simulation Analysis – Computer-Aided Engineering Tools

- Thermal Simulation
- Circuit Simulation
- EMI Field Simulation
- Detailed Mechanical Design
- PCB Layout and Tracking
- Structural Simulation

### Emerson Computer-Aided Engineering Tools



Thermal Simulation

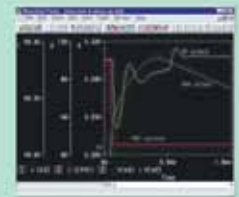

Circuit Simulation

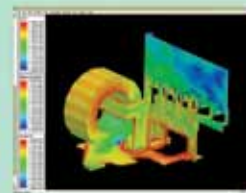

EMI Field Simulation



Detailed Mechanical Design



PCB Layout and Tracking



Structural Simulation



## MyPower Community Portal

**Discover. Communicate. Collaborate.**

MyPower is a free community portal that provides a variety of tools and resources including:



### Community

Utilizing the tools and resources provided will increase your standard knowledge base of our industry. Resources include:

- Industry Links
- What's New
- Trade Shows
- Tools & Calculators



### Knowledge Base

Familiarize yourself with our products and services. This section is designed to help build your industry knowledge.

- Product Videos
- White Papers
- Industry Books
- Educational Product Videos



### Support

Emerson Network Power strives to support your needs. In this section you will find:

- Factory Quality, Safety and Environmental Certifications

To sign up for a free MyPower account go to [www.Emerson.com/MyPower](http://www.Emerson.com/MyPower)



twitter

facebook

YouTube  
Broadcast Yourself™

### Stay Connected.

The latest happenings are being posted on Twitter, Facebook and YouTube! Sign up for one or all of the sites below and stay connected with Emerson Network Power!

[www.twitter.com/EmersonEmPower](http://www.twitter.com/EmersonEmPower)

[www.facebook.com/EmersonPowerSupplies](http://www.facebook.com/EmersonPowerSupplies)

[www.youtube.com/EmersonNetworkPower](http://www.youtube.com/EmersonNetworkPower)





## AC-DC Power Supplies

*Emerson Network Power is widely acknowledged as an industry leader and produces an exceptionally wide range of AC-DC power conversion products.*



# Low Power

Open frame/enclosed 1-4 outputs

20-500 Watts

## Special Features



### All models feature:

- Industry standard footprints
- Wide-range AC input
- Full power to 50 °C
- High demonstrated MTBF
- Overvoltage protection
- Overload protection
- Built-in EMI filtering
- Extensive safety approvals
- Derated operation to 70 °C

### Many models feature:

- EN61000-3-2 compliance
- Supervisory outputs (5 V/12 V)
- Wide-adjust floating 4<sup>th</sup> output
- Single wire current share
- Medical approvals
- Remote sense
- Adjustable outputs
- Power fail
- Wide-adjust on single output models
- Derated operation to 80 °C

| Output Power   |  | Output              |                       |                  |                       | Size W x L x H (mm)   | Model         |         |
|--|--|---------------------|-----------------------|------------------|-----------------------|-----------------------|---------------|---------|
| [Forced Air]   | Free Air   | V1                  | V2                    | V3               | V4                    |                       |               |         |
| <b>[40 W]</b>  | <b>25 W</b>  | <b>LP20 Series</b>  |                       |                  |                       |                       |               |         |
|  <p>(1)</p>   |  | 5V@5A [8A]*         |                       |                  |                       | 3" x 5" x 1.2"        | LPS22         |         |
|  |  | 12V@2.1A [3.3A]*    |                       |                  |                       | (76.2 x 127 x 30.5)   | LPS23         |         |
|  |  | 15V@1.7A [2.7]*     |                       |                  |                       |                       | LPS24         |         |
|  |  | 24V@1.1A [1.8A]*    |                       |                  |                       |                       | LPS25         |         |
|  |  | 5V@3A [4A]          | 12V@1.5A [2A]         | -12V@0.5A [0.7A] |                       |                       |               | LPT22   |
|  |  | 5V@4A [5A]          | 12V@0.5A [0.7A]       | -12V@0.5A [0.7A] |                       |                       |               | LPT23   |
|  |  | 5V@3A [4A]          | 12V@1.5A [2A]         | -5V@0.5A [0.7A]  |                       |                       |               | LPT24   |
|  |  | 5V@3A [4A]          | 15V@1.5A [2A]         | -15V@0.5A [0.7A] |                       |                       |               | LPT25   |
|  | <b>[40 W]</b>  | <b>25 W</b>         | <b>NPS20-M Series</b> |                  |                       |                       |               |         |
|  |  <p>(1)</p> |                     | 5V@5A [8A]*           |                  |                       |                       | 2" x 4" x 1"  | NPS22-M |
|  |  | 12V@2.1A [3.3A]*    |                       |                  |                       | (50.8 x 101.6 x 25.4) | NPS23-M       |         |
|  |  | 15V@1.7A [2.7]*     |                       |                  |                       |                       | NPS24-M       |         |
|  |  | 24V@1A [1.8A]*      |                       |                  |                       |                       | NPS25-M       |         |
|  |  | 48V@0.5A [0.84A]*   |                       |                  |                       |                       | NPS28-M       |         |
| <b>[47 W]</b>  | <b>Enclosed</b>  | <b>LCT43-E</b>      |                       |                  |                       |                       |               |         |
|             |  | 5V@4A [7A]          | 12V@1A [1.2A]         | -12V@0.5A [0.5A] |                       | 3.2" x 6.2" x 1.5"    | LCT43-E       |         |
|  |  |                     |                       |                  | (81.3 x 157.5 x 38.1) |                       |               |         |
| <b>[50 W]</b>  | <b>40 W</b>  | <b>NLP40 Series</b> |                       |                  |                       |                       |               |         |
|  <p>(1)</p> |  | 3.3V@9A*            |                       |                  |                       | 2.5" x 4.25" x 1.15"  | NLP40-76S3J   |         |
|  |  | 12V@4A*             |                       |                  |                       | (63.5 x 108 x 29.2)   | NLP40-7612J   |         |
|  |  | 5V@9A*              |                       |                  |                       |                       | NLP40-7605J   |         |
|  |  | 12V@4A*             |                       |                  |                       |                       | NLP40-7612J   |         |
|  |  | 15V@3.3A*           |                       |                  |                       |                       | NLP40-7615J   |         |
|  |  | 24V@2A*             |                       |                  |                       |                       | NLP40-7624J   |         |
|  |  | 48V@1A*             |                       |                  |                       |                       | NLP40-7617J   |         |
|  |  | 5V@4.5A             | 12V@3A                |                  |                       |                       | NLP40-7629J   |         |
|  |  | 12V@2.1A            | -12V@2.1A             |                  |                       |                       | NLP40-7627J   |         |
|  |  | 3.3V@4.5A           | 12V@3A                | -12V@0.5A        |                       |                       | NLP40-76T366J |         |
|  | 5V@4.5A  | 12V@3A              | -12V@0.5A             |                  |                       | NLP40-7608J           |               |         |
|  | 5V@4.5A  | 15V@2A              | -15V@0.5A             |                  |                       | NLP40-7610J           |               |         |

Options:  
 [ ] Rating with 30 CFM of air  
 (1) Optional cover/enclosure  
 \* Floating output

| Output Power  |               | Output                |                       |                 |    | Size W x L x H (mm)   | Model      |
|---|---------------|-----------------------|-----------------------|-----------------|----|-----------------------|------------|
| [Forced Air]  | Free Air      | V1                    | V2                    | V3              | V4 |                       |            |
| <b>[55 W]</b>   | <b>40 W</b>   | <b>LP40 Series</b>    |                       |                 |    |                       |            |
| <br>(1)                  |               | 3.3V@8A[11A]*         |                       |                 |    | 3" x 5" x 1.2"        | LPS41      |
|   |               | 5V@8A[11A]*           |                       |                 |    | (76.2 x 127 x 30.5)   | LPS42      |
|   |               | 12V@3.3A[4.5]*        |                       |                 |    |                       | LPS43      |
|   |               | 15V@2.6A[3.6A]*       |                       |                 |    |                       | LPS44      |
|   |               | 24V@1.6A[2.3A]*       |                       |                 |    |                       | LPS45      |
|   |               | 48V@0.9A[1.2A]*       |                       |                 |    |                       | LPS48      |
|   |               | 3.3V@4A[7A]           | 5V@1.5A[2A]           | +12V@0.5A[0.7A] |    |                       | LPT41      |
|   |               | 5V@4A[5A]             | 12V@2A[2.5A]          | -12V@0.5A[0.7A] |    |                       | LPT42      |
|   |               | 5V@6A[8A]             | 12V@0.5A[0.7A]        | -12V@0.5A[0.7A] |    |                       | LPT43      |
|   |               | 5V@4A[5A]             | 12V@2A[2.5A]          | -5V@0.5A[0.7A]  |    |                       | LPT44      |
|   |               | 5V@4A[5A]             | 15V@2A[2.5A]          | -15V@0.5A[0.7A] |    |                       | LPT45      |
|   |               | 5V@4A[5A]             | 24V@1A[1.5A]          | +12V@0.5A[0.7A] |    |                       | LPT46      |
|   |               | 5V@4A[5A]             | 24V@1A[1.5A]          | -12V@0.5A[0.7A] |    |                       | LPT47      |
|   | <b>[55 W]</b> | <b>45 W</b>           | <b>NPT40-M Series</b> |                 |    |                       |            |
| <br><b>NEW!</b>          |               | 5V@5A[8A]             | 12V@2.5A[3A]          | -12V@0.5A[0.7A] |    |                       | NPT42-M    |
|   |               | 5V@5A[8A]             | 15V@2A[2.4A]          | -15V@0.5A[0.7A] |    |                       | NPT43-M    |
|   |               | 5V@5A[8A]             | 24V@1A[1.5A]          | 12V@0.5A[0.7A]  |    |                       | NPT44-M    |
| <b>[60 W]</b>   | <b>45 W</b>   | <b>NPS40-M Series</b> |                       |                 |    |                       |            |
| <br>(1)                 |               | 5V@8A[11A]*           |                       |                 |    | 2" x 4" x 1"          | NPS42-M    |
|   |               | 12V@3.75A[5A]*        |                       |                 |    | (50.8 x 101.6 x 25.4) | NPS43-M    |
|   |               | 15V@3A[4A]*           |                       |                 |    |                       | NPS44-M    |
|   |               | 24V@1.9A[2.5A]*       |                       |                 |    |                       | NPS45-M    |
|   |               | 48V@0.94A[1.25A]*     |                       |                 |    |                       | NPS48-M    |
| <b>[55 W]</b>   | <b>55 W</b>   | <b>LP50 Series</b>    |                       |                 |    |                       |            |
| <br>(1)                |               | 3.3V@8A               | 5V@3A                 | 12V@0.5A        |    | 2" x 4" x 1.3"        | LPT51      |
|   |               | 5V@8A                 | 12V@3A                | -12V@0.5A       |    | (50.8 x 101.6 x 33)   | LPT52      |
|   |               | 5V@8A                 | 15V@2.4A              | -15V@0.5A       |    |                       | LPT53      |
|   |               | 5V@8A                 | 24V@1.5A              | 12V@0.5A        |    |                       | LPT54      |
| <b>[60 W]</b>   | <b>60 W</b>   | 5V@11A*               |                       |                 |    |                       | LPS52      |
| <br>(1)                |               | 5V@11A*               |                       |                 |    |                       | LPS52 (-I) |
|   |               | 12V@5A*               |                       |                 |    |                       | LPS53      |
|   |               | 12V@5A*               |                       |                 |    |                       | LPS53 (-I) |
|   |               | 15V@4A*               |                       |                 |    |                       | LPS54      |
|   |               | 24V@2.5A*             |                       |                 |    |                       | LPS55      |
|   |               | 48V@1.25A*            |                       |                 |    |                       | LPS58      |
| <b>[60 W]</b>   | <b>60 W</b>   | <b>NPS60-M Series</b> |                       |                 |    |                       |            |
| <br><b>NEW!</b><br>(1) |               | 5V@11A*               |                       |                 |    | 2" x 4" x 1"          | NPS62-M    |
|   |               | 12V@5A*               |                       |                 |    | (50.8 x 101.6 x 25.6) | NPS63-M    |
|   |               | 15V@4A*               |                       |                 |    |                       | NPS64-M    |
|   |               | 24V@2.5A*             |                       |                 |    |                       | NPS65-M    |

Options:

[ ] Rating with 30 CFM of air

(1) Optional cover/enclosure

\* Floating output

(-I) Industrial version -40 °C up to 80 °C (derated)

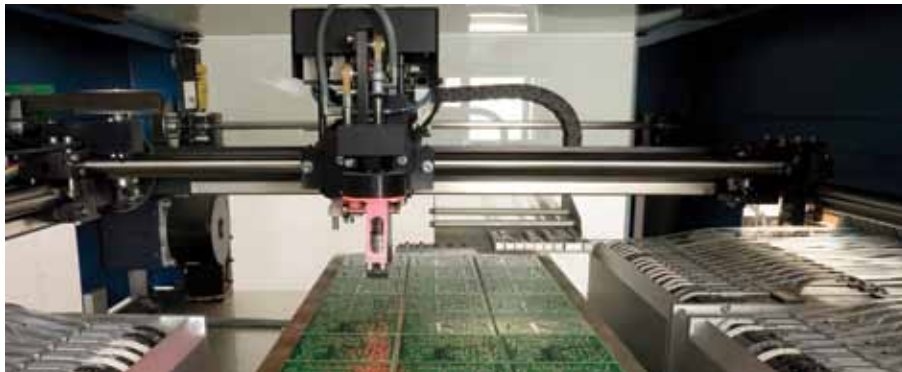
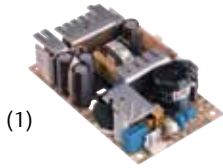

| Output Power  |             | Output              |             |                      |                 | Size W x L x H (mm)           | Model               |                                 |
|---------------|-------------|---------------------|-------------|----------------------|-----------------|-------------------------------|---------------------|---------------------------------|
| [Forced Air]  | Free Air    | V1                  | V2          | V3                   | V4              |                               |                     |                                 |
| <b>[75 W]</b> | <b>65 W</b> | <b>NLP65 Series</b> |             |                      |                 |                               |                     |                                 |
|               |             |                     |             | 5V@12A*              |                 |                               | 3" x 5" x 1.26"     | NLP65-7605J                     |
|               |             |                     |             | 5V@12A*              |                 |                               | (76.2 x 127 x 32)   | NLP65-9605J <sup>(5)(G)</sup>   |
|               |             |                     |             | 12V@6.5A*            |                 |                               |                     | NLP65-7612J <sup>(G)</sup>      |
|               |             |                     |             | 12V@6.5A*            |                 |                               |                     | NLP65-9612J <sup>(5)(G)</sup>   |
|               |             |                     |             | 24V@3.5A*            |                 |                               |                     | NLP65-7624J <sup>(G)</sup>      |
|               |             |                     |             | 24V@3.5A*            |                 |                               |                     | NLP65-9624J <sup>(5)(G)</sup>   |
|               |             |                     |             | 5V@8A                | 12V@3A          |                               |                     | NLP65-7629J                     |
|               |             |                     |             | 5V@8A                | 12V@3A          |                               |                     | NLP65-9629J <sup>(5)(G)</sup>   |
|               |             |                     |             | 5V@8A                | 24V@2A          | +12V@1.0A                     |                     | NLP65-3322J                     |
|               |             |                     |             | 5V@8A                | 12V@3A          | -12V@0.8A                     |                     | NLP65-7608J <sup>(G)</sup>      |
|               |             |                     |             | 5V@8A                | 12V@3A          | -12V@0.8A                     |                     | NLP65-9608J <sup>(5)(E,G)</sup> |
|               |             |                     |             | 5V@8A                | 15V@2.5A        | -15V@0.8A                     |                     | NLP65-7610GJ                    |
|               |             |                     |             | 5V@8A                | 15V@2.5A        | -15V@0.8A                     |                     | NLP65-9610J <sup>(5)(G)</sup>   |
|               |             |                     |             | 5V@8A                | 24V@2A          |                               |                     | NLP65-7620J                     |
|               |             | 5V@8A               | 24V@2A      |                      |                 | NLP65-9620J <sup>(5)(G)</sup> |                     |                                 |
| <b>[80 W]</b> | <b>60 W</b> | <b>LP60 Series</b>  |             |                      |                 |                               |                     |                                 |
|               |             |                     |             | 3.3V@12A [16A]*      |                 |                               | 3" x 5" x 1.65"     | LPS61                           |
|               |             |                     |             | 5V@12A [16A]*        |                 |                               | (76.2 x 127 x 41.9) | LPS62                           |
|               |             |                     |             | 12V@5A [6.7A]*       |                 |                               |                     | LPS63                           |
|               |             |                     |             | 15V@4A [5.3A]*       |                 |                               |                     | LPS64                           |
|               |             |                     |             | 24V@2.5A [3.3A]*     |                 |                               |                     | LPS65                           |
|               |             |                     |             | 48V@1.3A [1.7A]*     |                 |                               |                     | LPS68                           |
|               |             |                     |             | 3.3V@5A [8.5A]       | 5V@2.5A [3A]    | +12V@0.5A [1A]                |                     | LPT61                           |
|               |             |                     |             | 5V@7A [8A]           | 12V@3A [3.5A]   | -12V@0.7A [1A]                |                     | LPT62                           |
|               |             |                     |             | 5V@7A [8A]           | 15V@2.8A [3.3A] | -15V@0.7A [1A]                |                     | LPT63                           |
|               |             |                     |             | 5V@7A [8A]           | 12V@3A [3.5A]   | -5V@0.7A [1A]                 |                     | LPT64                           |
|               |             |                     |             | 5V@7A [8A]           | 24V@1.5A [2A]   | +12V@0.7A [1A]                |                     | LPT65                           |
|               |             | <b>[110 W]</b>      | <b>80 W</b> | <b>NLP110 Series</b> |                 |                               |                     |                                 |
|               |             |                     |             | 5V@22A*              |                 |                               | 3" x 6.5" x 1.26"   | NLP110-9605J                    |
|               |             |                     |             | 12V@9.2A*            |                 |                               | (76.2 x 165.1 x 32) | NLP110-9612J                    |
|               |             |                     |             | 24V@4.6A*            |                 |                               |                     | NLP110-9624J                    |
|               |             |                     |             | 48V@2.3A*            |                 |                               |                     | NLP110-9617J                    |
|               |             |                     |             | 5V@18A               | 3.3V@20A        | 12V@1A                        |                     | NLP110-9693J                    |
|               |             | 12V@8.5A            | 5V@18A      | -12V@1A              |                 | NLP110-9608J <sup>(5)</sup>   |                     |                                 |





Options:

- (E) To order an enclosed version of the NLP65-9608J, add suffix 'EJ' to the end of the model number, e.g., NLP65-9608EJ. The enclosed version includes: IEC connector, on/off switch, wire harness output connector and fitted cover.
- (G) A safety earth ground pin and ground choke are available as an option. To order, please add the suffix 'GJ' to the end of the model number e.g. NLP65-9612GJ.

- [ ] Rating with 30 CFM of air
- (1) Optional cover/enclosure
- \* Floating output
- (5) These modules feature harmonic current correction to EN6100-3-2

| Output Power  |              | Output  |                    |                                   |   |  |          |
|---|--------------|---|--------------------|-----------------------------------|---|--|----------|
| [Forced Air]  | Free Air     |   |                    |                                   |   |  |          |
| <b>[130 W]</b>  | <b>80 W</b>  | <b>LPT100-M Series</b>  |                    |                                   |   |  |          |
|   |              | 3.3 V @ 13 A [18 A]   | 5 V @ 5 A [9 A]    | 12 V @ 1 A [2.3 A]                | 2" x 4" x 1.28"                             | LPT101-M                                 |          |
|   |              | 5 V @ 13 A [18 A]   | 12 V @ 5 A [9 A]   | -12 V @ 1 A [2 A]                 | (50.8 x 101.6 x 32.7)                       | LPT102-M                                 |          |
|   |              | 5 V @ 13 A [18 A]   | 15 V @ 4 A [7.2 A] | -15 V @ 1 A [1.5 A]               |   | LPT103-M                                 |          |
|   |              | 5 V @ 13 A [18 A]   | 24 V @ 1.5 A [3 A] | 12 V @ 1 A [2.3 A]                |   | LPT104-M                                 |          |
|    | (1)          |   |                    |                                   |   |  |          |
|   |              |   |                    |                                   |   |  |          |
| <b>[145 W]</b>  | <b>80 W</b>  | <b>LP140 Series</b>   |                    |                                   |   |  |          |
|   |              | 5 V @ 12 A [25 A]<br>(3.3-5 V)  | 12 V @ 5 A [6 A]   | -12 V @ 1 A [1.5 A]<br>(-12-15 V) | ±3.3-25 V @<br>1.5 A [4.5 A]*               | 4" x 7" x 1.5"<br>(101.6 x 177.8 x 38.1) | LPQ142   |
|    | (1)          |   |                    |                                   |   |  |          |
|   |              |   |                    |                                   |   |  |          |
| <b>[150 W]</b>  | <b>100 W</b> | <b>TLP150 Series</b>  |                    |                                   |   |  |          |
|   |              | 12 V @ 12.5 A*  |                    |                                   | 3" x 5" x 1.25"                             | TLP150R-96S12J <sup>(f)</sup>            |          |
|   |              | 24 V @ 6.3 A*   |                    |                                   | (76.2 x 127 x 31.75)                        | TLP150R-96S24J <sup>(f)</sup>            |          |
|   |              | 36 V @ 4.2 A*   |                    |                                   |   | TLP150R-96S36J                           |          |
|   |              | 48 V @ 3.2 A*   |                    |                                   |   | TLP150R-96S48J <sup>(f)</sup>            |          |
|    | (1)          |   |                    |                                   |   |  |          |
|   |              |   |                    |                                   |   |  |          |
| <b>[150 W]</b>  | <b>100 W</b> | <b>LPS100-M Series</b>  |                    |                                   |   |  |          |
|   |              | 5 V @ 16 A [24 A]*  |                    |                                   | 2" x 4" x 1.29"                             | LPS102-M                                 |          |
|   |              | 12 V @ 8.3 A [12.5 A]*  |                    |                                   | (50.8 x 101.6 x 33)                         | LPS103-M                                 |          |
|   |              | 15 V @ 6.7 A [10 A]*  |                    |                                   |   | LPS104-M                                 |          |
|   |              | 24 V @ 4.2 A [6.3 A]*   |                    |                                   |   | LPS105-M                                 |          |
|   |              | 48 V @ 2.1 A [3.1 A]*   |                    |                                   |   | LPS108-M                                 |          |
|   |              | 54 V @ 1.85 A [2.8 A]*  |                    |                                   |   | LPS109-M                                 |          |
|    | (1)          |   |                    |                                   |   |  |          |
|   |              |   |                    |                                   |   |  |          |
| <b>[175 W]</b>  | <b>110 W</b> | <b>LP170 Series</b>   |                    |                                   |   |  |          |
|   |              | 5 V @ 22 A [35 A]*<br>(2.5-6 V)   |                    |                                   | 4.25" x 8.5" x 1.5"<br>(108 x 215.9 x 38.1) | LPS172                                   |          |
|   |              | 12 V @ 9.1 A [15 A]*<br>(6-12 V)  |                    |                                   |   | LPS173                                   |          |
|   |              | 15 V @ 7.3 A [12 A]*<br>(12-24 V)   |                    |                                   |   | LPS174                                   |          |
|   |              | 24 V @ 4.5 A [7.5]*<br>(24-54 V)  |                    |                                   |   | LPS175                                   |          |
|   |              | 5 V @ 15 A [30 A]<br>(3.3-5.5 V)  | 12 V @ 6 A [8 A]   | -12 V @ 0.2 A [3 A]<br>(-12-15 V) | ±3.3-25 V @<br>2 A [5 A]*                   |  | LPQ172   |
|   |              | 5 V @ 10 A [24 A]<br>(3.3-5.5 V)  | 12 V @ 6 A [8 A]   | -12 V @ 1.2 A [3 A]<br>(-12-15 V) | 5 V @ 10 A [24 A]*<br>(3.3-5 V)             |  | LPQ173   |
|   |              |  | (1)                |                                   |   |  |          |
|   |              |   |                    |                                   |   |  |          |
| <b>[200 W]</b>  | <b>100 W</b> | <b>LPQ200-M Series</b>  |                    |                                   |   |  |          |
|   |              | 3.3 V @ 13 A [18 A]   | 5 V @ 13 A [18 A]  | 12 V @ 5 A [9 A]                  | -12 V @ 1 A [2 A]                           | 3" x 5" x 1.32"                          | LPQ201-M |
|   |              | 5 V @ 13 A [18 A]   | 12 V @ 5 A [9 A]   | 24 V @ 1.5 A [3 A]                | -12 V @ 1 A [2 A]                           | (76.2 x 127 x 33.6)                      | LPQ202-M |
|  | (1)          |   |                    |                                   |   |  |          |
|   |              |   |                    |                                   |   |  |          |

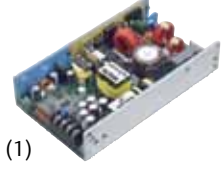
Options:  
 [ ] Rating with 30 CFM of air  
 (1) Optional cover/enclosure  
 \* Floating output

| Output Power  |              | Output                             |               |  |                    | Size W x L x H (mm)    | Model          |
|---|--------------|------------------------------------|---------------|--|--------------------|------------------------|----------------|
| [Forced Air]  | Free Air     | V1                                 | V2            | V3                                       | V4                 |                        |                |
| <b>[250 W]</b><br><br>(1)        | <b>125 W</b> | <b>LPS200-M Series</b>             |               |  |                    |                        |                |
|   |              | 5 V @ 20 A [40 A]*                 |               |  |                    | 3" x 5" x 1.32"        | LPS202-M       |
|   |              | 12 V @ 10.3 A [20.8 A]*            |               |  |                    | (76.2 x 127 x 33.6)    | LPS203-M       |
|   |              | 15 V @ 8.3 A [16.6 A]*             |               |  |                    |                        | LPS204-M       |
|   |              | 24 V @ 5.2 A [10.4 A]*             |               |  |                    |                        | LPS205-M       |
|   |              | 48 V @ 2.6 A [5.2 A]*              |               |  |                    |                        | LPS208-M       |
| <b>[250 W]</b><br><br>(1)        | <b>175 W</b> | <b>NLP250 Series</b>               |               |  |                    |                        |                |
|   |              | 12 V @ 21 A*                       |               |  |                    | 4" x 7" x 1.5"         | NLP250R-96S12J |
|   |              | 24 V @ 10.5 A*                     |               |  |                    | (101.6 x 177.8 x 38.1) | NLP250R-96S24J |
|   |              | 48 V @ 5.3 A*                      |               |  |                    |                        | NLP250R-96S48J |
|   |              | <b>NLP250 – DC (-48 Vdc Input)</b> |               |  |                    |                        |                |
| 12 V @ 14.6 A [21 A]  |              |                                    |               | 4" x 7" x 1.5"<br>(101.6 x 177.8 x 38.1) | NLP250N-48S12J     |                        |                |
| <b>[250 W]</b><br><br>(3), (4)    |              | <b>LP250 Series</b>                |               |  |                    |                        |                |
|   |              | 5 V (3-6 V) @ [50 A]*              |               |  |                    | 5" x 9" x 2"           | LPS252-C       |
|   |              | 12 V (6-12 V) @ [21 A]*            |               |  |                    | (127 x 228.6 x 50.8)   | LPS253-C       |
|   |              | 15 V (12-24 V) @ [16.7 A]*         |               |  |                    |                        | LPS254-C       |
|   |              | 24 V (24-48 V) @ [10.4 A]*         |               |  |                    |                        | LPS255-C       |
|   |              | 5 V @ [35 A]                       | 12 V @ [10 A] | -12 V @ [6 A]                            | ±5-25 V @ [6 A]*   |                        | LPQ252-C       |
|   |              | 5 V @ [35 A]                       | 15 V @ [10 A] | -15 V @ [6 A]                            | ±5-25 V @ [6 A]*   |                        | LPQ253-C       |
| <b>[350 W]</b><br><br>(3), (4) |              | <b>LP350 Series</b>                |               |  |                    |                        |                |
|   |              | 5 V (3-6 V) @ [70 A]*              |               |  |                    | 5" x 9" x 2.5"         | LPS352-C       |
|   |              | 12 V (6-12 V) @ [29.2 A]*          |               |  |                    | (127 x 228.6 x 63.5)   | LPS353-C       |
|   |              | 15 V (12-24 V) @ [23.3 A]*         |               |  |                    |                        | LPS354-C       |
|   |              | 24 V (24-48 V) @ [14.6 A]*         |               |  |                    |                        | LPS355-C       |
|   |              | 5 V @ [50 A]                       | 12 V @ [12 A] | -12 V @ [6 A]                            | ±3.3-24 V @ [6 A]* |                        | LPQ352-C       |
|   |              | 5 V @ [50 A]                       | 15 V @ [12 A] | -15 V @ [6 A]                            | ±3.3-24 V @ [6 A]* |                        | LPQ353-C       |
| <b>[350 W]</b><br><br>(3), (4)  | <b>200 W</b> | <b>NTS350 Series</b>               |               |  |                    |                        |                |
|   |              | 12 V @ 16.6 A [29.2 A]*            |               |  |                    | 4" x 7" x 1.5"         | NTS353         |
|   |              | 24 V @ 8.3 A [14.6 A]*             |               |  |                    | (101.6 x 177.8 x 38)   | NTS355         |
|   |              | 48 V @ 4.2 A [7.3 A]*              |               |  |                    |                        | NTS358         |
|   |              | 54 V @ 3.7 A [6.5 A]*              |               |  |                    |                        | NTS359         |
| <b>[500 W]</b><br><br>(3), (4) | <b>200 W</b> | <b>NTS500 Series</b>               |               |  |                    |                        |                |
|   |              | 12 V @ 16.6 A [41.7 A]*            |               |  |                    | 4" x 7" x 1.5"         | NTS503         |
|   |              | 24 V @ 8.3 A [20.8 A]*             |               |  |                    | (101.6 x 177.8 x 38)   | NTS505         |
|   |              | 18 V @ 11.1 A [27.7 A]*            |               |  |                    |                        | NTS506         |
|   |              | 48 V @ 4.2 A [10.4 A]*             |               |  |                    |                        | NTS508         |

Options:

[ ] Rating with 30 CFM of air

(1) Optional cover/enclosure

(3) Optional top fan cover (see datasheet for increased dimensions)

(4) Optional end fan cover (see datasheet for increased dimensions)

\* Floating output

# LCC250

Convection/conduction  
mounting

250 Watts

Total Power: 250 Watts  
# of Outputs: Single  
Output: 12 V, 24 V, 48 V



## Special Features

- Wide operating temperature range suited for both outdoor and indoor applications
- 250 W fanless power supply with zero derating up to 85 °C
- IP64 rated
- Conduction or convection mounting
- Differential remote sense
- Output adjust
- Output On/Off (Positive or negative logic user selectable)

## Electrical Specifications

| Input           |  |
|-----------------|--|
| Input range     | 90-264 Vac (Operating)<br>115/230 Vac (Nominal)  |
| Frequency       | 47-63 Hz   |
| Input fusing    | Internal fuse on both L and N lines  |
| Inrush current  | 50 A   |
| Power factor    | >0.92 full load  |
| Harmonics       | Meets EN61000-3-2; MIL-STD-461E: CE101;<br>CE102; CS101; CS104                         |
| Input current   | 3.4 A @ 90 Vac full load   |
| Hold up time    | 16 ms minimum at 115 Vac; 100% load  |
| Efficiency      | 230 Vac; 100% load<br>12 V - 89% typical<br>24 V - 91% typical<br>48 V - 91.5% typical |
| Leakage current | <275 µA at 230 Vac   |

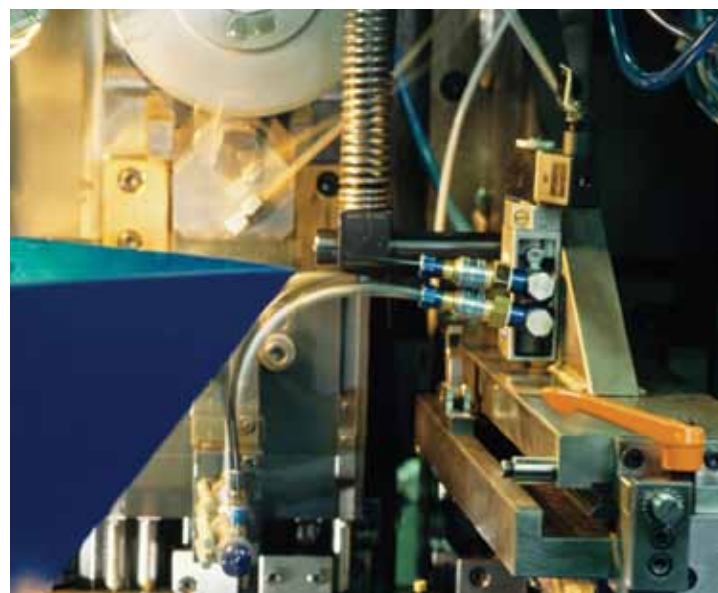

## Environmental Specifications

|                       |  |
|-----------------------|--|
| Operating temperature | Suffix 4P (conduction): -40 °C to +85 °C<br>baseplate temperature<br>Suffix 7P (convection): -40 °C to +85 °C<br>ambient temperature |
| Storage temperature   | -40 °C to 85 °C  |
| Humidity              | 10% to 100% (condensing & non-condensing)  |
| Altitude              | Operating: 13,000 feet<br>Non-operating: 50,000 feet   |
| Shock                 | IEC 68-2-27  |
| Vibration             | IEC 68-2-6 / IEC 721-3-2   |
| Ingress protection    | IP64 rated   |
| MTBF (calculated)     | >780,000 hours at 100% load; Low line;<br>Telcordia SR332  |

## Compliance

|                  |
|------------------|
| EMI Class B      |
| EN61000 Immunity |

## Safety

|           |   |
|-----------|---|
| UL + CSA  | 60950-1<br>ANSI E560601-1 3rd Ed.               |
| TÜV       | 60950-1<br>60601-1<br>61347-1; 2-13             |
| China     | CCC   |
| CB Scheme | IEC 60950-1<br>IEC 61347-1; 2-13<br>IEC 60601-1 |

## Electrical Specifications

| Output                                   |  |  |
|--|--|--|
| Output rating                            | 12 V @ 20.83 A<br>24 V @ 10.4 A<br>48 V @ 5.2 A  | —  |
| Set point                                | ±0.2%  | Factory set point  |
| Total regulation range                   | ±2%  | Line/load/temperature  |
| Rated load                               | 250 W maximum  | —  |
| Minimum load                             | 0 A Load   | No loss of regulation  |
| Capacitive load                          | 0-330 µF/amp   | —  |
| Constant output voltage adjustment range | 12 V: +10/-10%<br>24 V: +14.6/-15%<br>48 V: +15%/-15%  | Adjust via VR2   |
| Constant output current adjustment range | +0/-50%  | Adjust via VR1<br>CC mode supported from Vo nominal down to 80% Vo   |
| Output ripple and noise                  | 1%   | See Note 1   |
| Transient response                       | ±5% Vo max transient;<br>recovery <500 µs max  | 50% load step @ 1 A/µs<br>Step load verified at: 50% to 100% load; 90-264 Vac input;<br>capacitive load from 0 to 330 µF/Amp |
| Remote sense                             | Capable of stable offset of ±0.5 Vdc at output cable termination   | +SENSE (red wire); -SENSE (black wire)   |
| Output On/Off                            | Remote on/off referenced to secondary side. Positive or negative logic user selectable via CN2. Factory default is positive logic. | On/off (orange wire); on/off return (white wire)   |
| Overload protection (OCP)                | <150% Io   | Autorecovery   |
| Overvoltage protection (OVP)             | 110% to 135% Vo  | Latching mode; requires input AC recycle   |
| Overtemp protection (OTP)                | —  | Autorecovery; hiccup mode  |
| Output isolation                         | 4000 Vac Input to Output<br>1500 Vac Input to Ground<br>500 Vac Output to Ground   | —  |

## Ordering Information

| Model Number   | Output | Adjustment Range | Output Current |        | Output Ripple P/P <sup>1</sup> | Combined Line/ Load Regulation |
|----------------|--------|------------------|----------------|--------|--------------------------------|--------------------------------|
|                |        |                  | Min            | Max    |                                |                                |
| LCC250-12U-4P  | 12 V   | ±10%             | 0 A            | 20.8 A | 1%                             | ±2%                            |
| LCC250-12U-4PE | 12 V   | ±10%             | 0 A            | 20.8 A | 1%                             | ±2%                            |
| LCC250-12U-7P  | 12 V   | ±10%             | 0 A            | 20.8 A | 1%                             | ±2%                            |
| LCC250-12U-7PE | 12 V   | ±10%             | 0 A            | 20.8 A | 1%                             | ±2%                            |
| LCC250-24U-4P  | 24 V   | +14.6/-15%       | 0 A            | 10.4 A | 1%                             | ±2%                            |
| LCC250-24U-4PE | 24 V   | +14.6/-15%       | 0 A            | 10.4 A | 1%                             | ±2%                            |
| LCC250-24U-7P  | 24 V   | +14.6/-15%       | 0 A            | 10.4 A | 1%                             | ±2%                            |
| LCC250-24U-7PE | 24 V   | +14.6/-15%       | 0 A            | 10.4 A | 1%                             | ±2%                            |
| LCC250-48U-4P  | 48 V   | ±15%             | 0 A            | 5.2 A  | 1%                             | ±2%                            |
| LCC250-48U-4PE | 48 V   | ±15%             | 0 A            | 5.2 A  | 1%                             | ±2%                            |
| LCC250-48U-7P  | 48 V   | ±15%             | 0 A            | 5.2 A  | 1%                             | ±2%                            |
| LCC250-48U-7PE | 48 V   | ±15%             | 0 A            | 5.2 A  | 1%                             | ±2%                            |

1. Output ripple measured at the end of the output cable terminated with 10 µF tantalum capacitor in parallel with 0.1 µF ceramic capacitor.
2. Additional external capacitance required to meet the indicated Output Ripple Limits. Please check the Technical Reference Notes.
3. China CCC approval applies to part numbers with "-xxE" suffixes only.



# Low Power

## External power adapters

### 3-100 Watts

### Special Features

**All models feature:**

- Wide-range AC input
- High demonstrated MTBF
- Overload protection
- Extensive safety approvals

**Many models feature:**

- EN61000-3-2 compliance
- Medical approvals
- Thermal protection
- Energy Star/ErP

**AC Input:**

- Wallmount
  - U.S. – 2-prong
  - China – 2-prong
  - Europe – 2-prong
  - United Kingdom – 3-prong
  - Australia – 2-prong
  - Korea – 2-prong
  - Japan – 2-prong
  - Interchangeable
- Freestanding
  - IEC320 2-pin (C14) & (C6)
  - IEC320 2-pin (C8)

**DC Output:**

- Single output
  - 2.5 mm barrel plug
  - 2.1 mm right angle plug



Output Power

#### 3 W



|                          | V1 | V2 | V3 | Size W x L x H (mm)                         | Model                              |
|--------------------------|----|----|----|---|------------------------------------|
| <b>DCH3 Series – USB</b> |    |    |    |   |                                    |
| 5 V @ 0.55 A             |    |    |    | 1.03" x 2.28" x 1.81"<br>(26.1 x 58 x 46)   | DCH3-050US-0001<br>DCH3-050US-0002 |
| 5 V @ 0.55 A             |    |    |    | 1.03" x 2.28" x 1.80"<br>(26.1 x 58 x 45.8) | DCH3-050EU-0005<br>DCH3-050EU-0006 |
| 5 V @ 0.55 A             |    |    |    | 2.02" x 2.28" x 0.91"<br>(51.2 x 57.8 x 23) | DCH3-050UK-0005<br>DCH3-050UK-0006 |
| 5 V @ 0.55 A             |    |    |    | 1.07" x 2.66" x 1.81"<br>(27.2 x 67.2 x 46) | DCH3-050US-0004                    |
| 5 V @ 0.55 A             |    |    |    | 1.07" x 2.66" x 1.81"<br>(27.2 x 67.2 x 46) | DCH3-050US-0005                    |
| 5 V @ 0.55 A             |    |    |    | 2.02" x 2.64" x 0.97"<br>(51.2 x 67 x 24.5) | DCH3-050US-0006                    |

#### 5 W



|                    | V1 | V2 | V3 | Size W x L x H (mm)                             | Model      |
|--------------------|----|----|----|---|------------|
| <b>DCH5 Series</b> |    |    |    |   |            |
| 5 V @ 1 A          |    |    |    | 1" x 1.4" x 1.88"<br>(25.5 x 35.5 x 47.9)       | DCH5-050US |
| 5 V @ 1 A          |    |    |    | 1" x 1.4" x 1.88"<br>(25.5 x 35.5 x 47.9)       | DCH5-050EU |
| 5 V @ 1 A          |    |    |    | 1.74" x 1.95" x 2.19"<br>(44.2 x 49.53 x 55.62) | DCH5-050UK |
| 5 V @ 1 A          |    |    |    | 1" x 1.4" x 1.88"<br>(25.5 x 35.5 x 47.9)       | DCH5-050AU |

Output Power

**12 W**



| V1                   | V2 | V3 | Size W x L x H (mm)                         | Model                          |
|----------------------|----|----|---|--------------------------------|
| <b>DA12-M Series</b> |    |    |   |                                |
| 5V@2A                |    |    | 1.10" x 2.36" x 2.14"<br>(28 x 60 x 54.3)   | DA12-050AU-M                   |
| 12V@1A               |    |    |   | DA12-120AU-M                   |
| 5V@2A                |    |    | 1.10" x 2.36" x 2.48"<br>(28 x 60 x 63.1)   | DA12-050EU-M                   |
| 12V@1A               |    |    |   | DA12-120EU-M                   |
| 5V@2A                |    |    | 1.98" x 2.36" x 1.90"<br>(50.2 x 60 x 48.3) | DA12-050UK-M                   |
| 12V@1A               |    |    |   | DA12-120UK-M                   |
| 5V@2A                |    |    | 1.10" x 2.36" x 1.99"<br>(28 x 60 x 50.6)   | DA12-050US-M                   |
| 12V@1A               |    |    |   | DA12-120US-M                   |
| 5V@2A                |    |    | 1.1" x 2.36" x 2.06"<br>(28 x 60 x 52.3)    | DA12-050MP-M <sup>(1)</sup>    |
| 5V@2A                |    |    |   | DA12-050MP-M2.1 <sup>(2)</sup> |
| 12V@1A               |    |    | 1.10" x 2.36" x 2.14"<br>(28 x 60 x 54.3)   | DA12-120MP-M <sup>(1)</sup>    |
| 12V@1A               |    |    |   | DA12-120MP-M2.1 <sup>(2)</sup> |

**18 W**



|                      |  |  |   |                                |
|----------------------|--|--|---|--------------------------------|
| <b>DA18-M Series</b> |  |  |   |                                |
| 12V@1.5A             |  |  | 1.1" x 2.36" x 2.14"<br>(28 x 60 x 54.3)    | DA18-120AU-M                   |
| 15V@1.2A             |  |  |   | DA18-150AU-M                   |
| 12V@1.5A             |  |  | 1.1" x 2.36" x 2.48"<br>(28 x 60 x 63.1)    | DA18-120EU-M                   |
| 15V@1.2A             |  |  |   | DA18-150EU-M                   |
| 12V@1.5A             |  |  | 1.98" x 2.36" x 1.90"<br>(50.2 x 60 x 48.3) | DA18-120UK-M                   |
| 15V@1.2A             |  |  |   | DA18-150UK-M                   |
| 12V@1.5A             |  |  | 1.1" x 2.36" x 1.99"<br>(28 x 60 x 50.6)    | DA18-120US-M                   |
| 15V@1.2A             |  |  |   | DA18-150US-M                   |
| 12V@1.5A             |  |  | 1.1" x 2.36" x 2.06"<br>(28 x 60 x 52.3)    | DA18-120MP-M <sup>(1)</sup>    |
| 12V@1.5A             |  |  |   | DA18-120MP-M2.1 <sup>(2)</sup> |
| 15V@1.2A             |  |  |   | DA18-150MP-M <sup>(1)</sup>    |
| 12V@1.2A             |  |  |   | DA18-150MP-M2.1 <sup>(2)</sup> |



**24 W**



|             |  |  |   |           |
|-------------|--|--|---|-----------|
| <b>AD24</b> |  |  |   |           |
| 12V@2A      |  |  | 1.89" x 4.13" x 1.3"<br>(48 x 105 x 33) | AD2412N3L |

Options:

- (1) Interchangeable AC plug - must be purchased separately.
- (2) 2.1 mm x 5.5 mm barrel plug

| Output Power  | V1                  | V2 | V3 | Size W x L x H (mm)                        | Model          |
|---|---------------------|----|----|--|----------------|
| <b>40 W</b><br>    | <b>DP40 Series</b>  |    |    |  |                |
|   | 9V@4.4A             |    |    | 2.4" x 4.88" x 1.55"                       | DP4009N2M      |
|   | 9V@4.4A             |    |    | (61 x 124 x 39.5)                          | DP4009N3M      |
|   | 12V@3.33 A          |    |    |  | DP4012N2M      |
|   | 12V@3.33 A          |    |    |  | DP4012N3M      |
|   | 15V@2.67 A          |    |    |  | DP4015N2M      |
|   | 15V@2.67 A          |    |    |  | DP4015N3M      |
|   | 18V@2.22 A          |    |    |  | DP4018N2M      |
|   | 18V@2.22 A          |    |    |  | DP4018N3M      |
|   | 24V@1.67 A          |    |    |  | DP4024N2M      |
|   | 24V@1.67 A          |    |    |  | DP4024N3M      |
|   | 48V@0.84 A          |    |    |  | DP4048N2M      |
|   | 48V@0.84 A          |    |    |  | DP4048N3M      |
| <b>60 W</b><br>    | <b>DPS50 Series</b> |    |    |  |                |
|   | 5V@6A               |    |    | 2.39" x 5.24" x 1.62"                      | DPS52          |
|   | 12V@5A              |    |    | (60.7 x 133 x 41.15)                       | DPS53          |
|   | 15V@4A              |    |    |  | DPS54          |
|   | 24V@2.5A            |    |    |  | DPS55          |
|   | 48V@1.25A           |    |    |  | DPS58          |
| <b>100 W</b><br> | <b>AD100</b>        |    |    |  |                |
|   | 48V@2.08 A          |    |    | 2.56" x 6.14" x 1.44"<br>(65 x 156 x 37.2) | AD10048P3L-001 |



# Healthcare AC-DC Power Supplies

Up to 4920 Watts

Emerson Network Power produces a wide range of AC-DC power supplies certified for use in medical equipment requiring lower safety ground leakage and higher isolation. The power supplies listed below are designed for use in non-patient critical applications: bio-life science, medical, dental, imaging and laboratory applications such as immunoassay and in-vitro diagnostics machines, ultrasound and mass analyzers. All these power supplies are high efficiency switch-mode designs, and feature medical safety approval to EN60601-1.







## Special Features

**All models feature:**









- Industry standard footprints
- Wide-range AC input
- Remote sense
- Adjustable outputs
- Power fail
- Full power to 50 °C
- High demonstrated MTBF
- Overvoltage protection
- Overload protection
- Built-in EMI filtering
- Medical approvals
- Extensive safety approvals
- Derated operation to 70 °C

**Many models feature:**

- EN61000-3-2 compliance
- Supervisory outputs (5 V/12 V)
- Wide-adjust floating 4<sup>th</sup> output
- Single wire current share
- Wide-adjust on single output models
- Voltage monitor/data logging
- Real-time parametric adjustment & control

| Output Power  |                    | Output                  |                    |                       |         | Size W x L x H (mm)   | Model   |
|---|--------------------|-------------------------|--------------------|-----------------------|---------|-----------------------|---------|
| [Forced Air]  | Free Air           | V1                      | V2                 | V3                    | V4      |                       |         |
| <b>[40 W]</b><br><br>(1)          | <b>25 W</b>        | <b>NPS20-M Series</b>   |                    |                       |         |                       |         |
|   |                    | 5 V @ 5 A [8 A]*        |                    |                       |         | 2" x 4" x 1"          | NPS22-M |
|   |                    | 12 V @ 2.1 A [3.3 A]*   |                    |                       |         | (50.8 x 101.6 x 25.4) | NPS23-M |
|   |                    | 15 V @ 1.7 A [2.7 A]*   |                    |                       |         |                       | NPS24-M |
|   |                    | 24 V @ 1 A [1.8 A]*     |                    |                       |         |                       | NPS25-M |
|   |                    | 48 V @ 0.52 A [0.84 A]* |                    |                       |         |                       | NPS28-M |
| <b>[55 W]</b><br><br>(1)         | <b>40 W</b>        | <b>LP40-M Series</b>    |                    |                       |         |                       |         |
|   |                    | 5 V @ 8 A [11 A]*       |                    |                       |         | 3" x 5" x 1.2"        | LPS42-M |
|   |                    | 12 V @ 3.3 A [4.5]*     |                    |                       |         | (76.2 x 127 x 30.5)   | LPS43-M |
|   |                    | 15 V @ 2.6 A [3.6 A]*   |                    |                       |         |                       | LPS44-M |
|   |                    | 24 V @ 1.6 A [2.3 A]*   |                    |                       |         |                       | LPS45-M |
|   |                    | 5 V @ 4 A [5 A]         | 12 V @ 2 A [2.5 A] | -12 V @ 0.5 A [0.7 A] |         |                       | LPT42-M |
| 5 V @ 4 A [5 A]   | 15 V @ 2 A [2.5 A] | -15 V @ 0.5 A [0.7 A]   |                    |                       | LPT45-M |                       |         |
| <b>[60 W]</b><br><br>(1)         | <b>45 W</b>        | <b>NPS40-M Series</b>   |                    |                       |         |                       |         |
|   |                    | 5 V @ 8 A [11 A]*       |                    |                       |         | 2" x 4" x 1"          | NPS42-M |
|   |                    | 12 V @ 3.75 A [5 A]*    |                    |                       |         | (50.8 x 101.6 x 25.4) | NPS43-M |
|   |                    | 15 V @ 3 A [4 A]*       |                    |                       |         |                       | NPS44-M |
|   |                    | 24 V @ 1.9 A [2.5 A]*   |                    |                       |         |                       | NPS45-M |
| 48 V @ 0.94 A [1.25 A]*   |                    |                         |                    |                       | NPS48-M |                       |         |
| <b>[55 W]</b><br><br><b>NEW!</b> | <b>45 W</b>        | <b>NPT40-M Series</b>   |                    |                       |         |                       |         |
|   |                    | 5 V @ 5 A [8 A]         | 12 V @ 2.5 A [3 A] | -12 V @ 0.5 A [0.7 A] |         |                       | NPT42-M |
|   |                    | 5 V @ 5 A [8 A]         | 15 V @ 2 A [2.4 A] | -15 V @ 0.5 A [0.7 A] |         |                       | NPT43-M |
|   |                    | 5 V @ 5 A [8 A]         | 24 V @ 1 A [1.5 A] | 12 V @ 0.5 A [0.7 A]  |         |                       | NPT44-M |
| <b>[55 W]</b><br><br>(1)         | <b>55 W</b>        | <b>LP50-M Series</b>    |                    |                       |         |                       |         |
|   |                    | 3.3 V @ 8 A             | 5 V @ 3 A          | 12 V @ 0.5 A          |         | 2" x 4" x 1.3"        | LPT51-M |
|   |                    | 5 V @ 8 A               | 12 V @ 3 A         | -12 V @ 0.5 A         |         | (50.8 x 101.6 x 33)   | LPT52-M |
|   |                    | 5 V @ 8 A               | 15 V @ 2.4 A       | -15 V @ 0.5 A         |         |                       | LPT53-M |
|   |                    | 5 V @ 8 A               | 24 V @ 1.5 A       | 12 V @ 0.5 A          |         |                       | LPT54-M |

Options:  
 [ ] Rating with 30 CFM of air  
 (1) Optional cover/enclosure  
 \* Floating output

| Output Power   |              | Output                 |    |                  |                   | Size W x L x H (mm)     | Model                       |                            |
|--|--------------|------------------------|----|------------------|-------------------|-------------------------|-----------------------------|----------------------------|
| [Forced Air]   | Free Air     | V1                     | V2 | V3               | V4                |                         |                             |                            |
| <b>[60 W]</b><br><br>(1)                | <b>60 W</b>  | <b>LPS52-M Series</b>  |    |                  |                   |                         | LPS52-M                     |                            |
|  |              |                        |    |                  |                   |                         | LPS53-M                     |                            |
|  |              |                        |    |                  |                   |                         | LPS54-M                     |                            |
|  |              |                        |    |                  |                   |                         | LPS55-M                     |                            |
|  |              |                        |    |                  |                   |                         | LPS58-M                     |                            |
| <b>[60 W]</b><br><br><b>NEW!</b><br>(1) | <b>60 W</b>  | <b>NPS60-M Series</b>  |    |                  |                   |                         | NPS62-M                     |                            |
|  |              |                        |    |                  |                   | 2" x 4" x 1"            | NPS63-M                     |                            |
|  |              |                        |    |                  |                   | (50.8 x 101.6 x 25.6)   | NPS64-M                     |                            |
|  |              |                        |    |                  |                   |                         | NPS65-M                     |                            |
|  |              |                        |    |                  |                   |                         | NPS65-M                     |                            |
| <b>[75 W]</b><br><br>(1)                | <b>65 W</b>  | <b>NLP65 Series</b>    |    |                  |                   |                         | NLP65-9912J <sup>(5)</sup>  |                            |
|  |              |                        |    |                  |                   | 3" x 5" x 1.26"         | NLP65-9915J <sup>(5)</sup>  |                            |
|  |              |                        |    |                  |                   | (76.2 x 27 x 32)        | NLP65-9924J <sup>(5)</sup>  |                            |
|  |              |                        |    | 5V @ 8A          | 12V @ 3A          |                         |                             | NLP65-9929J <sup>(5)</sup> |
|  |              |                        |    | 5V @ 8A          | 24V @ 2A          |                         |                             | NLP65-9920J <sup>(5)</sup> |
|  |              |                        |    | 5V @ 8A          | 12V @ 3A          | -12V @ 1A               | NLP65-9908J <sup>(5)</sup>  |                            |
|  |              |                        |    |                  |                   |                         |                             |                            |
| <b>[80 W]</b><br><br>(1)               | <b>60 W</b>  | <b>LP60-M Series</b>   |    |                  |                   |                         | LPS63-M                     |                            |
|  |              |                        |    |                  |                   | 3" x 5" x 1.65"         | LPS64-M                     |                            |
|  |              |                        |    |                  |                   | (76.2 x 127 x 41.9)     | LPS65-M                     |                            |
|  |              |                        |    | 5V @ 7A [8A]     | 12V @ 3A [3.5A]   | -12V @ 0.7A [1A]        | LPT62-M                     |                            |
|  |              |                        |    | 5V @ 7A [8A]     | 15V @ 2.8A [3.3A] | -15V @ 0.7A [1A]        | LPT63-M                     |                            |
| <b>[110 W]</b><br><br>(1)             | <b>80 W</b>  | <b>NLP110 Series</b>   |    |                  |                   |                         | NLP110-9905J                |                            |
|  |              |                        |    |                  |                   | 3" x 6.5" x 1.26"       | NLP110-9912J                |                            |
|  |              |                        |    |                  |                   | (76.2 x 165.1 x 45.72)  | NLP110-9924J                |                            |
|  |              |                        |    |                  |                   |                         | NLP110-9917J                |                            |
|  |              |                        |    | 3.3V @ 20A       | 2.5V @ 20A        | 12V @ 1A                | NLP110-9994J                |                            |
|  |              |                        |    | 5V @ 18A         | 3.3V @ 20A        | 12V @ 1A                | NLP110-9993J                |                            |
|  |              |                        |    | 12V @ 8.5A       | 3.3V @ 20A        | -12V @ 1A               | NLP110-9995J                |                            |
|  |              |                        |    | 12V @ 8.5A       | 5V @ 18A          | -12V @ 1A               | NLP110-9908J                |                            |
| <b>[130 W]</b><br><br>(1)             | <b>80 W</b>  | <b>LPT100-M Series</b> |    |                  |                   |                         | LPT101-M                    |                            |
|  |              |                        |    | 3.3V @ 13A [18A] | 5V @ 5A [9A]      | 12V @ 1A [2.3A]         | 2" x 4" x 1.28"             | LPT102-M                   |
|  |              |                        |    | 5V @ 13A [18A]   | 12V @ 5A [9A]     | -12V @ 1A [2A]          | (50.8 x 101.6 x 32.7)       | LPT103-M                   |
|  |              |                        |    | 5V @ 13A [18A]   | 15V @ 4A [7.2A]   | -15V @ 1A [1.5A]        | LPT104-M                    |                            |
|  |              |                        |    | 5V @ 13A [18A]   | 24V @ 1.5A [3A]   | 12V @ 1A [2.3A]         | LPT104-M                    |                            |
| <b>[150 W]</b><br><br>(1)             | <b>100 W</b> | <b>LPS100-M Series</b> |    |                  |                   |                         | LPS102-M                    |                            |
|  |              |                        |    |                  |                   | 2" x 4" x 1.29"         | LPS103-M                    |                            |
|  |              |                        |    |                  |                   | (50.8 x 101.6 x 33)     | LPS104-M                    |                            |
|  |              |                        |    |                  |                   |                         | LPS105-M                    |                            |
|  |              |                        |    |                  |                   |                         | LPS108-M                    |                            |
| <b>[150 W]</b><br><br>(1)             | <b>100 W</b> | <b>TLP150 Series</b>   |    |                  |                   |                         | TLP150N-99S12J <sup>F</sup> |                            |
|  |              |                        |    |                  |                   | 3" x 5" x 1.25"         | TLP150N-99S24J <sup>F</sup> |                            |
|  |              |                        |    |                  |                   | (177.8 x 101.6 x 31.75) |                             |                            |

**Options:**

F Replace the 'J' at the end of the model number with 'FJ' when the optional standby output and/or remote ON/OFF control is required e.g., TLP150N-99S12FJ  
 [ ] Rating with 30 CFM of air

(1) Optional cover/enclosure (see datasheet for increased dimensions)  
 (5) These models feature harmonic current correction to EN61000-3-2  
 \* Floating output

| Output Power  |                                | Output                         |                    |                    |   | Size W x L x H (mm)    | Model              |
|---|--------------------------------|--------------------------------|--------------------|--------------------|---|------------------------|--------------------|
| [Forced Air]  | Free Air                       | V1                             | V2                 | V3                 | V4  |                        |                    |
| <b>[175 W]</b><br><br>(1)                | <b>110 W</b>                   | <b>LP170-M Series</b>          |                    |                    |   |                        |                    |
|   |                                | 5 V @ 22 A [35 A]* (2.5-6 V)   |                    |                    |   | 4.25" x 8.5" x 1.5"    | LPS172-M           |
|   |                                | 12 V @ 9.1 A [15 A]* (6-12 V)  |                    |                    |   | (108 x 215.9 x 38.1)   | LPS173-M           |
|   |                                | 15 V @ 7.3 A [12 A]* (12-24 V) |                    |                    |   |                        | LPS174-M           |
|   |                                | 24 V @ 4.5 A [7.5]* (24-54 V)  |                    |                    |   |                        | LPS175-M           |
| <b>[200 W]</b><br><br>(1)                | <b>100 W</b>                   | <b>LPQ200-M Series</b>         |                    |                    |   |                        |                    |
|   |                                | 3.3 V @ 13 A [18 A]            | 5 V @ 13 A [18 A]  | 12 V @ 5 A [9 A]   | -12 V @ 1 A [2 A]                             | 3" x 5" x 1.32"        | LPQ201-M           |
|   |                                | 5 V @ 13 A [18 A]              | 12 V @ 5 A [9 A]   | 24 V @ 1.5 A [3 A] | -12 V @ 1 A [2 A]                             | (76.2 x 127 x 33.6)    | LPQ202-M           |
| <b>[250 W]</b><br><br>(1)                | <b>125 W</b>                   | <b>LPS200-M Series</b>         |                    |                    |   |                        |                    |
|   |                                | 5 V @ 20 A [40 A]*             |                    |                    |   | 3" x 5" x 1.32"        | LPS202-M           |
|   |                                | 12 V @ 10.3 A [20.8 A]*        |                    |                    |   | (76.2 x 127 x 33.6)    | LPS203-M           |
|   |                                | 15 V @ 8.3 A [16.6 A]*         |                    |                    |   |                        | LPS204-M           |
|   |                                | 24 V @ 5.2 A [10.4 A]*         |                    |                    |   |                        | LPS205-M           |
| 48 V @ 2.6 A [5.2 A]*   |                                |                                |                    |                    | LPS208-M                                      |                        |                    |
| <b>[250 W]</b><br><br>(1)                | <b>175 W</b>                   | <b>NLP250 Series</b>           |                    |                    |   |                        |                    |
|   |                                | 12 V @ 21 A*                   |                    |                    |   | 4" x 7" x 1.5"         | NLP250N-99S12J     |
|   |                                | 24 V @ 10.5 A*                 |                    |                    |   | (101.6 x 177.8 x 38.1) | NLP250N-99S24J     |
| <b>[250 W]</b><br><br><b>NEW!</b>       | <b>250 W</b>                   | <b>LCC250 Series</b>           |                    |                    |   |                        |                    |
|   |                                | 12 V @ 20.8 A                  |                    |                    |   | 4" x 7" x 1.1"         | See LCC250 section |
|   |                                | 24 V @ 10.4 A                  |                    |                    |   | (101.6 x 177.8 x 28)   |                    |
|   |                                | 48 V @ 5.2 A                   |                    |                    |   |                        |                    |
| <b>[500 W]</b><br><br>(4), (5)         | <b>200 W</b>                   | <b>NTS500-M Series</b>         |                    |                    |   |                        |                    |
|   |                                | 12 V @ 16.6 A [41.7 A]*        |                    |                    |   | 4" x 7" x 1.5"         | NTS503-M           |
|   |                                | 24 V @ 8.3 A [20.8 A]*         |                    |                    |   | (101.6 x 177.8 x 38)   | NTS505-M           |
|   |                                | 48 V @ 4.2 A [10.4 A]*         |                    |                    |   |                        | NTS508-M           |
| <b>[300 W]</b><br><br><b>NEW!</b>      | <b>LCM300 Bulk Front End</b>   |                                |                    |                    |   |                        |                    |
|   | 12-60 V                        | Single outputs                 |                    |                    | 1.61" x 4.0" x 7.0"<br>(4.09 x 101.6 x 177.8) | See LCM300 section     |                    |
| <b>[600 W]</b><br><br><b>NEW!</b>      | <b>LCM600 Bulk Front End</b>   |                                |                    |                    |   |                        |                    |
|   | 3.3-60 V                       | Single outputs                 |                    |                    | 4.5" x 7.5" x 2.4"<br>(114.3 x 190.5 x 62)    | See LCM600 section     |                    |
| <b>[1500 W]</b><br><br><b>NEW!</b>     | <b>LCM1500 Bulk Front End</b>  |                                |                    |                    |   |                        |                    |
|   | 12-60 V                        | Single outputs                 |                    |                    | 2.5" x 5.2" x 10.0"<br>(63.5 x 132.1 x 254)   | See LCM1500 section    |                    |
| <b>Up to 1200 W</b><br><br><b>NEW!</b> | <b>µMP Medium Power Series</b> |                                |                    |                    |   |                        |                    |
|   | 0.9-60 V                       | 1-12 outputs                   | Fully configurable |                    | 3.5" x 10.11" x 1.57"<br>(88.9 x 256.9 x 40)  | See µMP section        |                    |

Options:

(1) Optional cover/enclosure

(4) Optional top fan covers (see datasheet for increased dimensions)

\* Floating output

(5) Optional end fan cover (see datasheet for increased dimensions)

| Output Power<br>[Forced Air]      Free Air  | Output                       |              |                                    |    | Size W x L x H (mm)                   | Model           |
|---|------------------------------|--------------|------------------------------------|----|---------------------------------------|-----------------|
|   | V1                           | V2           | V3                                 | V4 |                                       |                 |
| <b>Up to 1500 W</b>   | <b>Intelligent MP Series</b> |              |                                    |    |                                       |                 |
|  | 2-60 V                       | 1-21 outputs | Fully configurable and intelligent |    | 5" x 10" x 2.5"<br>(127 x 254 x 63.5) | See iMP section |

|   |                              |              |                                    |  |                                      |                 |
|---|------------------------------|--------------|------------------------------------|--|--------------------------------------|-----------------|
| <b>1500-4920 W</b>  | <b>Intelligent VS Series</b> |              |                                    |  |                                      |                 |
|  | 2-60 V                       | 1-24 outputs | Fully configurable and intelligent |  | 5" x 11" x 5"<br>(127 x 279.4 x 127) | See iVS section |

| Output Power  | V1                   | V2 | V3 | Size W x L x H (mm)                         | Model                          |
|---|----------------------|----|----|---|--------------------------------|
| <b>12 W</b>   | <b>DA12-M Series</b> |    |    |   |                                |
|  | 5V@2A                |    |    | 1.10" x 2.36" x 2.14"<br>(28 x 60 x 54.3)   | DA12-050AU-M                   |
|   | 12V@1A               |    |    |   | DA12-120AU-M                   |
|   | 5V@2A                |    |    | 1.10" x 2.36" x 2.48"<br>(28 x 60 x 63.1)   | DA12-050EU-M                   |
|   | 12V@1A               |    |    |   | DA12-120EU-M                   |
|   | 5V@2A                |    |    | 1.98" x 2.36" x 1.90"<br>(50.2 x 60 x 48.3) | DA12-050UK-M                   |
|   | 12V@1A               |    |    |   | DA12-120UK-M                   |
|   | 5V@2A                |    |    | 1.10" x 2.36" x 1.99"<br>(28 x 60 x 50.6)   | DA12-050US-M                   |
|   | 12V@1A               |    |    |   | DA12-120US-M                   |
|   | 5V@2A                |    |    | 1.1" x 2.36" x 2.06"<br>(28 x 60 x 52.3)    | DA12-050MP-M <sup>(1)</sup>    |
|   | 5V@2A                |    |    |   | DA12-050MP-M2.1 <sup>(2)</sup> |
|   | 12V@1A               |    |    | 1.10" x 2.36" x 2.14"<br>(28 x 60 x 54.3)   | DA12-120MP-M <sup>(1)</sup>    |
|   | 12V@1A               |    |    |   | DA12-120MP-M2.1 <sup>(2)</sup> |

|   |                      |  |  |   |                                |
|---|----------------------|--|--|---|--------------------------------|
| <b>18 W</b>   | <b>DA18-M Series</b> |  |  |   |                                |
|  | 12V@1.5A             |  |  | 1.1" x 2.36" x 2.14"<br>(28 x 60 x 54.3)    | DA18-120AU-M                   |
|   | 15V@1.2A             |  |  |   | DA18-150AU-M                   |
|   | 12V@1.5A             |  |  | 1.1" x 2.36" x 2.48"<br>(28 x 60 x 63.1)    | DA18-120EU-M                   |
|   | 15V@1.2A             |  |  |   | DA18-150EU-M                   |
|   | 12V@1.5A             |  |  | 1.98" x 2.36" x 1.90"<br>(50.2 x 60 x 48.3) | DA18-120UK-M                   |
|   | 15V@1.2A             |  |  |   | DA18-150UK-M                   |
|   | 12V@1.5A             |  |  | 1.1" x 2.36" x 1.99"<br>(28 x 60 x 50.6)    | DA18-120US-M                   |
|   | 15V@1.2A             |  |  |   | DA18-150US-M                   |
|   | 12V@1.5A             |  |  | 1.1" x 2.36" x 2.06"<br>(28 x 60 x 52.3)    | DA18-120MP-M <sup>(1)</sup>    |
|   | 12V@1.5A             |  |  |   | DA18-120MP-M2.1 <sup>(2)</sup> |
|   | 15V@1.2A             |  |  |   | DA18-150MP-M <sup>(1)</sup>    |
|   | 12V@1.2A             |  |  |   | DA18-150MP-M2.1 <sup>(2)</sup> |

|   |                        |  |  |                       |         |
|---|------------------------|--|--|-----------------------|---------|
| <b>60 W</b>   | <b>DPS50-M Medical</b> |  |  |                       |         |
|  | 5V@6A                  |  |  | 2.39" x 5.24" x 1.62" | DPS52-M |
|   | 12V@5A                 |  |  | (60.7 x 133 x 41.15)  | DPS53-M |
|   | 15V@4A                 |  |  |                       | DPS54-M |
|   | 24V@2.5A               |  |  |                       | DPS55-M |
|   | 48V@1.25A              |  |  |                       | DPS58-M |

Options:  
 (1) Interchangeable AC plug - must be purchased separately.  
 (2) 2.1 mm x 5.5 mm barrel plug

# LED Lighting Drivers

Up to 150 Watts



NEW!

## Special Features

- Constant current and constant voltage operation
- Flexible dimming options
- Free-air rated—no forced air necessary for cooling

## Compliance

- Includes Class 2 outputs
- Includes IP20, IP64 and IP67 water protection
- CISPR 15/FCC Part 15 EMI performance
- Class C harmonics
- >0.9 power factor

## Safety

|     |                 |
|-----|-----------------|
| EN  | 61347-2-13      |
| UL  | 8750            |
| CSA | C22.2 No. 107.1 |
| CE  | Mark            |

## Electrical Specifications

| Input                  |   |
|------------------------|---|
| Input range            | 90-264 Vac (U models); 90-305 Vac (H models)  |
| Input frequency        | 47-63 Hz  |
| Input fusing           | Internally fused  |
| Output                 |   |
| Constant current       | Capable of operating in constant current mode to directly drive LEDs and have optional adjustable current levels* |
| Constant voltage       | Designed to operate in constant voltage mode over a specified range to power external LED drivers*                |
| Control and Protection |   |
| Current limit          | Adjustable*   |
| Protection             | Short Circuit/Overvoltage/Overtemperature   |

\* Refer to data sheet for detailed information.

## Ordering Information

| Model Number     | Input Voltage Range | Rated Output Voltage | Rated Output Current | Dimming Interface           | IP Rating  |
|------------------|---------------------|----------------------|----------------------|-----------------------------|------------|
| LDS25-36-H03U    | 90-305 Vac          | 36 Vdc               | 700 mA dc            | 0-10 V                      | IP20       |
| LDS25-36-H03F    | 90-305 Vac          | 36 Vdc               | 700 mA dc            | 0-10 V                      | Open-frame |
| LDS70-12-U00     | 90-264 Vac          | 12 Vdc               | 5.0 Adc              | None                        | IP67       |
| LDS70-12-H03     | 90-305 Vac          | 12 Vdc               | 5.0 Adc              | 0-10 V                      | IP67       |
| LDS70-58-U00     | 90-264 Vac          | 58 Vdc               | 1.2 Adc              | None                        | IP67       |
| LDS70-58-U01     | 90-264 Vac          | 58 Vdc               | 1.2 Adc              | 2-level & DIP switch        | IP64       |
| LDS70-58-H03     | 90-305 Vac          | 58 Vdc               | 1.2 Adc              | 0-10 V                      | IP67       |
| LDS70-58-H04     | 90-305 Vac          | 58 Vdc               | 1.2 Adc              | Programmable <sup>(1)</sup> | IP67       |
| LDS100-24-U00    | 90-264 Vac          | 24 Vdc               | 4.1 Adc              | None                        | IP67       |
| LDS100-24-U04    | 90-264 Vac          | 24 Vdc               | 4.1 Adc              | Programmable <sup>(1)</sup> | IP67       |
| LDS100-24-H00    | 90-305 Vac          | 24 Vdc               | 4.1 Adc              | None                        | IP67       |
| LDS100-24-H03    | 90-305 Vac          | 24 Vdc               | 4.1 Adc              | 0-10 V                      | IP67       |
| LDS100-24-H04    | 90-305 Vac          | 24 Vdc               | 4.1 Adc              | Programmable <sup>(1)</sup> | IP67       |
| LDS100-31-H03    | 90-305 Vac          | 31 Vdc               | 3.16 Adc             | 0-10 V                      | IP67       |
| LDS100-31-H04    | 90-305 Vac          | 31 Vdc               | 3.16 Adc             | Programmable <sup>(1)</sup> | IP67       |
| LDS100-48-H03    | 90-305 Vac          | 48 Vdc               | 2.1 Adc              | Programmable <sup>(1)</sup> | IP67       |
| LDS150-1400-H03  | 90-305 Vac          | 107 Vdc              | 1400 mAdc            | 0-10 V                      | IP67       |
| LDS150-1400-H03C | 90-305 Vac          | 107 Vdc              | 1400 mAdc            | 0-10 V                      | IP67       |

Notes: 1. The Dimming Interface on these highly-flexible models can be programmed via a Graphical User-Interface. The options include 0-10V, 1-10V and Bi-Level dimming. Maximum and minimum current levels and threshold levels are also programmable.



# MicroMP Series

Cost-efficient, configurable power supply with market-leading density and efficiency

# μMP

## Up to 1200 Watts

Total Power: Up to 1200 Watts  
 Input Voltage: 85-264 Vac  
 120-300 Vdc  
 # of Outputs: Up to 12

**NEW!**



## Special Features

- Optional conformal coating
- Industrial temp range (-40 °C to 70 °C)
- Industrial shock/vibration (>50 G's)
- Low cost
- Low leakage (< 300 μA)
- PMBus
- High efficiency
- Low profile 1U size
- Multi output
- Current limit modification (foldback or constant current)
- High power density
  - μMP4: 10.8 W/cu-in
  - μMP1: 15.1 W/cu-in
- Intelligent fan (speed control/fault status)
- Downloadable GUI from website
- μP controlled PFC input with active inrush protection
- No preload required
- IEC or terminal block input

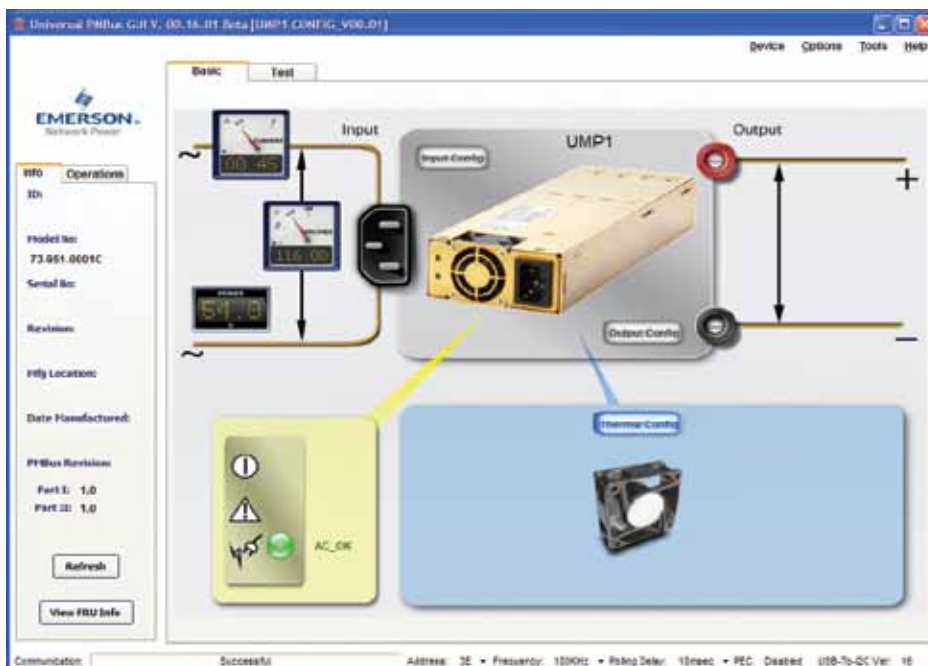

## Electrical Specifications



| Input           |  |
|-----------------|--|
| Input range     | 85-264 Vac<br>120-350 Vdc (limited to 250 Vac/300Vdc in medical apps)    |
| Frequency       | 47-440 Hz  |
| Inrush current  | 40 A peak max. (soft start)  |
| Efficiency      | Up to 91% @ full case load   |
| Power factor    | 0.99 typ. meets EN61000-3-2 (n/a @ 440 Hz)                               |
| Turn-on time    | AC on 2 sec for μMP1 and 1.5 sec for μMP4, inhibit/enable 250 ms typical |
| EMI filter      | CISPR 22/EN55022 Level "B"   |
| Leakage current | 300 μA max. @ 240 Vac for μMP1 and 500 μA max. for μMP4; 47-63 Hz        |
| Radiated EMI    | CISPR 22/EN55022 Level "B"   |
| Warranty        | Two years  |

## Electrical Specifications

| Output                     |   |
|----------------------------|---|
| Factory set point accuracy | ±1%   |
| Margining                  | ±3-7% nominal analog (single output module only)  |
| Overall regulation         | 0.4% or 30 mV which ever is greater   |
| Ripple                     | RMS: 0.1% or 10 mV, whichever is greater<br>Pk-Pk: 1.0% or 50 mV, whichever is greater<br>Bandwidth limited to 20 MHz |
| Dynamic response           | <±5% or 250 mV, with 50% step load  |
| Recovery time              | To within 1% in <300 μs   |
| Reverse voltage protection | 100% of rated output current  |
| Thermal protection (OTP)   | All outputs disabled when internal temp exceeds safe operating range.   |
| Remote sense               | Up to 0.5 V total drop (not available on triple output module)  |
| Single wire parallel       | Current share to within 5% of total rated current   |
| DC OK                      | ±5% of nominal  |
| Minimum load               | Not required  |
| Housekeeping standby       | 5 Vdc @ 1.0 A max. present whenever AC input is applied   |
| Module inhibit             | Logic - output on with low or open. Different logic options available   |
| Output/Output isolation    | >1 Megohm, 500 V  |

## Environmental Specifications

|                                |   |
|--------------------------------|---|
| Operating temperature          | -40 °C to 70 °C ambient.<br>Derate each output 2.5% per degree from 50 °C to 70 °C.<br>(-20 °C start up) Meets full spec after 1/2 load. 10 min warm-up |
| Storage temperature            | -40 °C to 85 °C   |
| Electromagnetic susceptibility | Designed to meet EN61000-4; -3, -6, -11 Level 3, Level 4 for -2, -4, -5   |
| Humidity                       | Operating; non-condensing<br>10% to 95% RH  |
| Vibration                      | MIL-STD-810E  |
| MTBF demonstrated              | >350,000 hours at full load, one μMP4 case + two modules, Telcordia SR-332 calculated MTBF  |
| Altitude:                      | Up to 10k feet; derate linear to 50% from 10k-30k feet  |

## Safety

|      |                                      |
|------|--------------------------------------|
| UL   | UL60950/UL60601-1                    |
| CSA  | CSA22.2 No. 234 Level 5              |
| VDE  | EN60950/EN60601-1                    |
| BABT | Compliance to EN60950/EN60601 BS7002 |
| CB   | Certificate and report               |
| CE   | Mark to LVD                          |
| CCC  | Approved                             |

## Voltage Codes

| Standard Output Ratings    |                                  |  |                |      |
|----------------------------|----------------------------------|--|----------------|------|
| Module Output Voltage Code | Single Output ONE SLOT 240 W Max | Dual Output ONE SLOT 192 W Max                     |                |      |
| Module Identification      | S2                               | D = Dual Common Ground<br>I = Dual Isolated Ground |                |      |
| Output Module Line-Up      |                                  |  |                |      |
| Code                       | Volts                            | Output Current V1                                  | Output Current |      |
|                            |                                  |  | V1             | V2   |
| A                          | 2.0                              | 40.0   | N/A            |      |
| B                          | 2.2                              | 40.0   | N/A            |      |
| C                          | 3.0                              | 40.0   | N/A            |      |
| D                          | 3.3                              | 40.0   | 4.0*           | 4.0* |
| E                          | 5.0                              | 36.0   | 4.0            | 4.0  |
| F                          | 5.2                              | 34.0   | 4.0            | 4.0  |
| G                          | 5.5                              | 32.0   | 4.0            | 4.0  |
| H                          | 6.0                              | 30.0   | 4.0            | 4.0  |
| I                          | 8.0                              | 25.0   | 4.0            | 4.0  |
| J                          | 10.0                             | 24.0   | 4.0            | 4.0  |
| K                          | 11.0                             | 22.0   | 4.0            | 4.0  |
| L                          | 12.0                             | 20.0   | 4.0            | 4.0  |
| M                          | 14.0                             | 17.0   | 4.0            | 4.0  |
| N                          | 15.0                             | 16.0   | 4.0            | 4.0  |
| O                          | 18.0                             | 13.0   | 4.0            | 4.0  |
| P                          | 20.0                             | 12.0   | 4.0            | 4.0  |
| Q                          | 24.0                             | 10.0   | 4.0            | 4.0  |
| R                          | 28.0                             | 8.6  | 3.4            | 3.4  |
| S                          | 30.0                             | 8.0  | N/A            |      |
| T                          | 33.0                             | 7.0  | N/A            |      |
| U                          | 36.0                             | 6.7  | N/A            |      |
| V                          | 42.0                             | 5.7  | N/A            |      |
| W                          | 48.0                             | 5.0  | N/A            |      |
| X                          | 54.0                             | 4.4  | N/A            |      |
| Y                          | 60.0                             | 4.0  | N/A            |      |

\* For "I" codes only

## Ordering Information

| Case Size   | Module/Voltage/Option Codes  | Case Option Codes   | Software Code                           | Hardware Code                           |
|---|--|---|---|---|
| <b>μMPXY</b>  | <b>S2E - DER - DLL</b>   | <b>00</b>   | <b>A</b>                                | <b>###</b>                              |
| <b>Case Size (mm)</b><br>Single-Phase Input where X =<br>4 = 1.57" x 3.5" x 10"; 400 W - 600 W, 4 slots<br>1 = 1.57" x 5" x 10"; 1000 W - 1200 W, 6 slots<br><br>Input Type where Y =<br>T = Terminal Block<br>C = IEC Connector, C14<br>B = IEC Connector, C16 | <b>Module Codes</b><br>S2 = 200 W Single O/P (1 slot)<br>D = 96 W/96 W Dual O/P Common Ground (1 slot)<br>I = 96 W/96 W Dual O/P Isolated Ground (1 slot)<br><br><b>Voltage Codes:</b><br>See Voltage Code Table | <b>Case Option Codes</b><br>First digit<br>0 - E = Parallel Code<br><br>Second digit<br>0 = No Options<br>1 = Reverse Air<br>3 = Global Enable<br>5 = Opt 1 + Opt 3 | Factory assigned for modified standards | Factory assigned for modified standards |

## MP Series

Modular power supply for optimum flexibility

Up to 1200 Watts

Total Power: Up to 1200 Watts  
 Input Voltage: 85-264 Vac  
 120-350 Vdc  
 # of Outputs: Up to 21



### Special Features

- Low cost
- Current share on all outputs with ratings of 10 A or greater
- Remote sense on all outputs with ratings greater than 2 A
- Overload protection on all outputs
- Voltage adjustment on all outputs
- Margining on all single output modules
- Input OK signal and status indicator LED
- Global DC OK signal and status indicator LED
- Global and individual module inhibits/enable
- Forced air cooling or customer provided air option
- Isolated 1 A 5 V bias voltage
- Power factor correction
- EN61000-3-2 harmonic distortion compliance
- CISPR 22, EN55022 Curve B conducted/radiated EMI
- European CE Mark requirements
- Optional VME timing and system DC OK module
- Low leakage option
- EN61000 immunity standards
- Standard modification flexibility (see datasheet on [Emerson.com/EmbeddedPower](http://Emerson.com/EmbeddedPower))

### Special Purpose Modules

- Battery charger module
- Extended hold-up module
- High voltage module (non-isolated)
- OR-ing diode module



### Electrical Specifications

| Input                                |  |
|--------------------------------------|--|
| Input voltage                        | 85-264 Vac<br>120-350 Vdc  |
| Frequency                            | 47-440 Hz  |
| Inrush current                       | 40 A peak maximum (soft start)   |
| Efficiency                           | 70-80% typ. @ full case load   |
| Power factor                         | 0.99 typ. meets EN61000-3-2 (N/A @ 440 Hz)   |
| Turn-on time                         | AC on 1.5 second typical<br>Inhibit/enable 150 ms typical                                  |
| EMI filter standard                  | CISPR 22<br>EN55022 Level "B"  |
| EMI filter (low leakage option)      | CISPR 22<br>EN55022 Level "A"  |
| Leakage current standard             | 2.0 mA maximum @ 240 Vac   |
| Leakage current (low leakage option) | 300 µA maximum @ 240 Vac   |
| Radiated EMI                         | CISPR 22<br>EN55022 Level "B"  |
| Holdover storage                     | 20 ms minimum (independent of input Vac)   |
| AC OK                                | >5 ms early warning minimum before outputs lose regulation<br>Full cycle ride thru (50 Hz) |
| Harmonic distortion                  | Meets EN61000-3-2  |
| Isolation                            | Meets EN60950  |
| Global inhibit/enable                | TTL, Logic "1" and Logic "0"; configurable   |
| Input fuse (internal)                | MP4: 10 A; MP6: 15 A; MP8: 20 A; MP1: 20 A   |
| Warranty                             | Two years  |

| Output  |   |
|---|---|
| Adjustment range                                      | ±10% minimum all outputs  |
| Margining   | ±4-6% nominal <sup>1</sup>  |
| Overall regulation                                    | 0.4% or 20 mV maximum<br>(36 W modules 4% maximum)  |
| Ripple  | RMS: 0.1% or 10 mV, whichever is greater; Pk-Pk: 1.0% or 50 mV, whichever is greater; bandwidth limited to 20 MHz   |
| Dynamic response                                      | <2% or 100 mV, with 25% load step   |
| Recovery time   | To within 1% in <300 µs second  |
| Overcurrent protection                                | Single, main of dual output module 105-120% of rated output current   |
| Short-circuit protection                              | Protected for continuous short-circuit<br>Recovery is automatic upon removal of short                               |
| Overvoltage protection (measured at sense connection) | Single output modules   |
| Reverse voltage protection                            | 100% of rated output current  |
| Thermal protection                                    | All outputs disabled when internal temp exceeds safe operating range. > 5 ms warning (AC OK signal) before shutdown |
| Remote sense  | Up to 0.5 V total drop (not available on triple output module)  |
| Single wire parallel                                  | Current share to within 2% of total rated current <sup>2</sup>  |
| DC OK   | -2% to -8% of nominal for any monitored output <sup>2</sup>   |
| Minimum load  | Not required on single or triple output modules.<br>10% required on main of dual output modules <sup>3</sup>        |
| Housekeeping standby                                  | 5 Vdc @1.0 A maximum present whenever AC input is applied (optional 2.0 A available)                                |
| Module inhibit  | TTL, isolated, singles and dual (both outputs) only   |
| Switching frequency                                   | 250 kHz   |
| Output/output isolation                               | >1 Megohm   |
| VME signal option board                               | POR signal & quad external DC OK  |

## Environmental Specifications

|                         |   |
|-------------------------|---|
| Operating temperature   | -20 °C to 50 °C (start @ 0 °C)<br>(derate each output linearly to 50% at 70 °C) (-20 °C to 40 °C max. with rear air option) |
| Shock/Vibration         | MIL-HDBK 810E   |
| Humidity                | 95% non-condensing  |
| Storage temperature     | -40 °C to 85 °C   |
| Temperature coefficient | 0.02% per °C  |
| Cooling:                | Internal DC fan or customer provided air (option)   |

## Safety

|      |                                 |
|------|---------------------------------|
| UL   | UL1950                          |
| CSA  | CSA22.2 No. 234 Level 5         |
| IEC  | IEC950, Class 1                 |
| VDE  | EN60950-1                       |
| BABT | Compliance to EN 60950, BS 7002 |
| CB   | Certificate and report          |
| CE   | Mark                            |

Notes:

1. Single output modules only
2. Single and main of dual output modules only
3. Contact factory for optional preload if required

## Ordering Information

Sample below is 1200 W case with 12 V @ 50 A; 5 V @ 60 A; 24 V @ 8.5 A; 12 V @ 10 A; 12 V @ 4 A; extended hold-up with no options.

| Case Size  | Module/Voltage(s)<br>First - Module Code<br>Second - Voltage Code  | Add-on Modules<br>Requires 1 slot each   | Case Option Codes  | Hardware Code                         |
|--|--|--|--|---------------------------------------|
| <b>MP1</b>   | <b>3L - 2E - 1Q - 4LL</b>  | <b>HUP</b>   | <b>00</b>  | <b>###</b>                            |
| <b>Case Size (mm)</b><br>4 = 2.5" x 5" x 10";<br>400-600 W, 5 Slots<br>(63.5 x 127 x 254)<br>6 = 2.5" x 5" x 11";<br>600-800 W, 5 Slots<br>(63.5 x 127 x 279.4)<br>8 = 2.5" x 7" x 10";<br>800-1000 W, 6 Slots<br>(63.5 x 177.8 x 254)<br>1 = 2.5" x 8" x 11";<br>1000-1200 W, 7 Slots<br>(63.5 x 203.2 x 279.4) | <b>Module Codes</b><br>Module/Voltage/Option Codes<br>Module Codes:<br>(None) = 36 W Triple O/P (1 slot)<br>1 = 210 W Single O/P (1 slot)<br>2 = 360 W Single O/P (2 slot)<br>3 = 750 W Single O/P (3 slot)<br>4 = 144 W Dual O/P (1 slot)<br>5 - 9 = Future<br><br><b>Voltage Codes:</b><br>See Output Module Voltage/<br>Current table | <b>Add-on Modules</b><br>HUP = Hold up module<br>VME = VME POR signal<br>and isolated DC | <b>Case Option Codes</b><br><br><b>First Digit</b><br>0 - 9 = parallel code<br>(See MP parallel codes table on<br>following page)<br><br><b>Second Digit</b><br>Standard Options<br><b>0</b> = no options<br><b>1</b> = rear air exhaust<br><b>3</b> = global enable<br><b>5</b> = option package<br>(options 1 & 3)<br><b>M</b> = low leakage<br><b>N</b> = low leakage plus option 1<br><b>P</b> = low leakage plus option 3<br><b>R</b> = low leakage plus option 5 | Factory assigned<br>for modifications |

# Intelligent MP Series

Intelligent modular power supply for optimum flexibility

Up to 1500 Watts

Total Power: Up to 1500 Watts  
 Input Voltage: 85-264 Vac  
 120-300 Vdc  
 # of Outputs: Up to 21

iMP™



## Special Features

- Medical EN60601-1 approval
- Intelligent I<sup>2</sup>C control
- Voltage adjustment on all outputs (Manual or I<sup>2</sup>C)
- Configurable input and output (case and module) OK signals and indicators
- Configurable inhibit/enable
- Configurable output UP/DOWN sequencing
- Configurable current limit (foldback or constant current)
- High power density (8.8 W/cu-in)
- Intelligent fan (speed control/fault status)
- Downloadable GUI from website
- Customer provided air option
- µP controlled PFC input with active inrush protection
- I<sup>2</sup>C monitor of voltage, current and temp
- Programmable voltage, current limit, inhibit/enable through I<sup>2</sup>C
- Optional extended hold-up module (SEMI F47 compliance)
- CAN BUS and RS-485 interface option
- Low leakage (<300 µA)
- Increased power density to 50% over standard MP
- Backward compatibility with standard MP
- External switching frequency sync input
- Optional conformal coating
- Industrial temp range (-40 °C to 70 °C)
- No preload required
- Industrial shock/vibration (>50 G's)

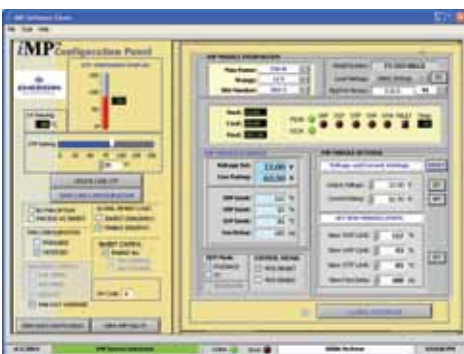

The iMP software is designed to make the iMP Power Supply Unit (PSU) accessible to the user. It is intended to provide information gathered from the PSU and interactive controls to the basic capabilities of iMP power supply. To download go to: [www.PowerConversion.com/impsoftware](http://www.PowerConversion.com/impsoftware)

## Electrical Specifications

| Input                 |   |
|-----------------------|---|
| Input range           | 85-264 Vac 120-350 Vdc (limited to 300 Vdc in medical applications)   |
| Frequency             | 47-440 Hz   |
| Inrush current        | 40 A peak max. (soft start)   |
| Efficiency            | Up to 85% @ full case load  |
| Power factor          | 0.99 typ. meets EN61000-3-2 (n/a @ 440 Hz)  |
| Turn-on time          | AC on 2 sec typ., inhibit/enable 150 ms typical Programmable delay; 50 ms internal turn-on delay (Dual Output only)       |
| EMI filter            | CISPR 22/EN55022 Level "B"  |
| Leakage current       | 300 µA max. @ 240 Vac; 47-63 Hz   |
| Radiated EMI          | CISPR 22/EN55022 Level "B"  |
| Holdover storage      | 20 ms minimum (independent of input Vac) additional 34 ms holdover storage with optional HUP module (SEMI F47 compatible) |
| AC OK                 | >5 ms early warning min. before outputs lose regulation Full cycle ride thru (50 Hz) (N/A on iMP4 > 750 W @ 90 Vac)       |
| Harmonic distortion   | Meets EN61000-3-2   |
| Isolation             | Meets EN60950 and EN60601   |
| Global Inhibit/Enable | TTL, Logic "1" and Logic "0"; configurable  |
| Input fuse (internal) | iMP4: 16 A; iMP8: 20 A; iMP1: 25 A (both lines fused)   |
| Warranty              | Two years   |

| Output                            |  |
|-----------------------------------|--|
| Adjustment range*                 | ±10% minimum all outputs (manual)<br>(full module adjustment range using I <sup>2</sup> C)   |
| Margining                         | ±4-6% nominal analog (single output module only)   |
| Overall regulation                | 0.4% or 20 mV max. (1500 W modules 1% max. 36 W modules 4% max.)   |
| Ripple                            | RMS: 0.1% or 10 mV, whichever is greater<br>Pk-Pk: 1.0% or 50 mV, whichever is greater<br>Bandwidth limited to 20 MHz  |
| Dynamic response                  | <2% or 100 mV, with 25% load step  |
| Recovery time                     | To within 1% in <300 µs  |
| Overcurrent protection**          | Configurable through I <sup>2</sup> C (calibration required). Single output module and main output of the dual output module 105-120% of rated output current. Aux output of dual output module 105-140% of rated output current |
| Short-circuit protection          | Protected for continuous short-circuit<br>Recovery is automatic upon removal of short  |
| Overvoltage protection*           | Configurable through I <sup>2</sup> C<br>- Single output module 2-5.5 V 122-134%; 6-60 V 110-120%<br>- Dual output module 2-6 V 122-134%; 8-28 V 110-120%<br>- Triple output module  |
| Reverse voltage protection        | 100% of rated output current   |
| Thermal protection* (OTP and OTW) | Configurable through I <sup>2</sup> C<br>All outputs disabled when internal temp exceeds safe operating range. > 5 ms warning (AC OK signal) before shutdown   |
| Remote sense                      | Up to 0.5 V total drop (not available on triple output module)   |
| Single wire parallel              | Current share to within 2% of total rated current  |
| DC OK*                            | ±5% of nominal. Configurable through I <sup>2</sup> C  |
| Minimum load                      | Not required   |
| Housekeeping standby              | 5 Vdc @ 1.0 A max. present whenever AC input is applied (Optional 2.0 A available)   |
| Module inhibit*                   | Configured and controlled through I <sup>2</sup> C   |
| Switching frequency               | 250 kHz accepts external sync signal   |
| Output/Output isolation           | >1 Megohm, 500 V   |

\* Can be controlled via I<sup>2</sup>C  
\*\* Controlled via I<sup>2</sup>C but requires load calibration

## Environmental Specifications

|                                |  |
|--------------------------------|--|
| Operating temperature          | -40 °C to 70 °C ambient.<br>Derate each output 2.5% per degree from 50 °C to 70 °C.<br>(-20 °C start up) |
| Storage temperature            | -40 °C to 85 °C  |
| Electromagnetic susceptibility | Designed to meet EN61000-4;<br>-2, -3, -4, -5, -6, -8, -11 Level 3                                       |
| Humidity                       | Operating; non-condensing<br>10% to 95% RH   |
| Vibration                      | IEC68-2-6 to the levels of<br>IEC721-3-2   |
| MTBF demonstrated              | >550,000 hours at full load,<br>220 Vac and 25 °C ambient conditions                                     |

## Safety

|      |  |
|------|--|
| UL   | UL60950/UL2601                           |
| CSA  | CSA22.2 No. 234 Level 5                  |
| VDE  | EN60950/EN60601-1                        |
| BABT | Compliance to EN60950/<br>EN60601 BS7002 |
| CB   | Certificate and report                   |
| CE   | Mark to LVD                              |

## Output Module Line-up

| Module Code                               | 1      | 2      | 3      | 4  | 5  |
|---|--------|--------|--------|--|--|
| Module Type                               | Single | Single | Single | Dual   | Triple   |
| Max output power                          | 210 W  | 360 W  | 750 W  | 144 W  | 36 W   |
| Max output current                        | 35 A   | 60 A   | 150 A  | 10 A   | 2 A  |
| Output voltages available*                | 2-60 V | 2-60 V | 2-60 V | 6-15, 24-28; 6-15, 6-15; 6-15, 2-6; 2-6, 2-6; 24-28, 24-28; 24-28; 2-6 | 8-15, 8-15, 2-6; 8-15, 8-15, 8-15, 8-15, 18-28; 8-15, 18-28, 2-6 |
| Standard voltage increments               | 25     | 25     | 25     | 16   | 18   |
| Remote sense                              | Yes    | Yes    | Yes    | Yes  | No   |
| Remote margin                             | Yes    | Yes    | Yes    | No   | No   |
| V-Program - I <sup>2</sup> C control      | Yes    | Yes    | Yes    | Yes  | No   |
| Active current share                      | Yes    | Yes    | Yes    | Yes  | No   |
| Module Inhibit - I <sup>2</sup> C control | Yes    | Yes    | Yes    | Yes  | Yes  |
| Module Inhibit - analog                   | Yes    | Yes    | Yes    | Yes  | No   |
| Overvoltage/overcurrent protection        | Yes    | Yes    | Yes    | Yes  | Yes  |
| Minimum load required                     | No     | No     | No     | No   | No   |
| Slots occupied in any iMP case            | 1      | 2      | 3      | 1  | 1  |

\* Programmable

## Output Module Voltage/Current

| Voltage         | Voltage Code | Single Output Module Code |        |        |         | Dual Output** |       | Triple Output |       |       | I <sup>2</sup> C Adjustment Ranges*** |
|-----------------|--------------|---------------------------|--------|--------|---------|---------------|-------|---------------|-------|-------|---------------------------------------|
|                 |              | 1                         | 2      | 3      | 5+      | V1            | V2    | -             | -     | -     |                                       |
| 2 V             | A            | 35 A                      | 60 A   | 150 A  | —       | 10 A          | 10 A  | —             | —     | 2 A   | 1.8-2.2                               |
| 2.2 V           | B            | 35 A                      | 60 A   | 150 A  | —       | 10 A          | 10 A  | —             | —     | 2 A   | 2.0-2.4                               |
| 3 V             | C            | 35 A                      | 60 A   | 150 A  | 300 A   | 10 A          | 10 A  | —             | —     | 2 A   | 2.7-3.3                               |
| 3.3 V           | D            | 35 A                      | 60 A   | 150 A  | 300 A   | 10 A          | 10 A  | —             | —     | 2 A   | 3.0-3.6                               |
| 5 V             | E            | 35 A                      | 60 A   | 150 A  | 300 A   | 10 A          | 10 A  | —             | —     | 2 A   | 4.5-5.5                               |
| 5.2 V           | F            | 35 A                      | 60 A   | 144 A  | 288 A   | 10 A          | 10 A  | —             | —     | 2 A   | 4.7-5.7                               |
| 5.5 V           | G            | 34 A                      | 58 A   | 136 A  | 273 A   | 10 A          | 10 A  | —             | —     | 2 A   | 5.0-6.1                               |
| 6 V             | H            | 23 A                      | 42 A   | 97.5 A | 250 A   | 10 A*         | 10 A* | —             | —     | 2 A   | 5.4-6.6                               |
| 8 V             | I            | 20 A                      | 36 A   | 84.4 A | 140 A   | 10 A          | 4 A   | 1 A           | 1 A   | 1 A   | 7.2-8.8                               |
| 10 V            | J            | 18 A                      | 32 A   | 75 A   | 140 A   | 10 A          | 4 A   | 1 A           | 1 A   | 1 A   | 9.0-11.0                              |
| 11 V            | K            | 17 A                      | 31 A   | 68 A   | 136.3 A | 10 A          | 4 A   | 1 A           | 1 A   | 1 A   | 9.9-12.1                              |
| 12 V            | L            | 17 A                      | 30 A   | 62.5 A | 125 A   | 10 A          | 4 A   | 1 A           | 1 A   | 1 A   | 10.8-13.2                             |
| 14 V            | M            | 14 A                      | 21 A   | 53.5 A | 107 A   | 9 A           | 4 A   | 1 A           | 1 A   | 1 A   | 12.6-15.4                             |
| 15 V            | N            | 14 A                      | 20 A   | 50 A   | 100 A   | 8 A           | 4 A   | 1 A           | 1 A   | 1 A   | 13.5-16.5                             |
| 18 V            | O            | 11 A                      | 19 A   | 41.6 A | 83.3 A  | —             | —     | —             | 0.5 A | 0.5 A | 16.2-19.8                             |
| 20 V            | P            | 10.5 A                    | 18 A   | 37.5 A | 75 A    | —             | —     | —             | 0.5 A | 0.5 A | 18.0-22.0                             |
| 24 V            | Q            | 8.5 A                     | 15 A   | 30 A   | 62.5 A  | 4 A           | 2 A   | —             | 0.5 A | 0.5 A | 21.6-26.4                             |
| 28 V            | R            | 6.7 A                     | 11 A   | 26.8 A | 53.5 A  | 3 A           | 2 A   | —             | 0.5 A | 0.5 A | 25.2-30.8                             |
| 30 V            | S            | 6.5 A                     | 11 A   | 25 A   | 50 A    | —             | —     | —             | —     | —     | 27.0-33.0                             |
| 33 V            | T            | 6.2 A                     | 10.9 A | 22.7 A | 35.8 A  | —             | —     | —             | —     | —     | 29.7-36.3                             |
| 36 V            | U            | 5.8 A                     | 10 A   | 20.8 A | 35.8 A  | —             | —     | —             | —     | —     | 32.4-39.6                             |
| 42 V            | V            | 4.2 A                     | 7.5 A  | 16 A   | 35.7 A  | —             | —     | —             | —     | —     | 37.8-46.2                             |
| 48 V            | W            | 4 A                       | 7.5 A  | 15.6 A | 31.2 A  | —             | —     | —             | —     | —     | 43.2-52.8                             |
| 54 V            | X            | 3.7 A                     | 6 A    | 13.9 A | 27.7 A  | —             | —     | —             | —     | —     | 48.6-59.4                             |
| 60 V            | Y            | 3.5 A                     | 6 A    | 12.5 A | 25 A    | —             | —     | —             | —     | —     | 54.0-66.0                             |
| Consult Factory |              |                           |        |        |         |               |       |               |       |       |                                       |
| Special         | Z            | 35 A                      | 60 A   | 150 A  | —       | —             | 10 A  | —             | —     | —     | 2.3-2.6                               |
| Special         | Z            | 35 A                      | 60 A   | 150 A  | —       | —             | 10 A  | —             | —     | —     | 3.7-4.4                               |
| Special         | Z            | 20 A                      | 36 A   | 80 A   | 140 A   | —             | 8 A   | —             | —     | —     | 6.7-7.1                               |

\* Note: Contact factory for extended range down to 6 V.  
 \*\* Total output power on dual module must not exceed 144 W.  
 \*\*\* For single output modules only.  
 + Applicable for iMP1 only.

### Parallel Codes

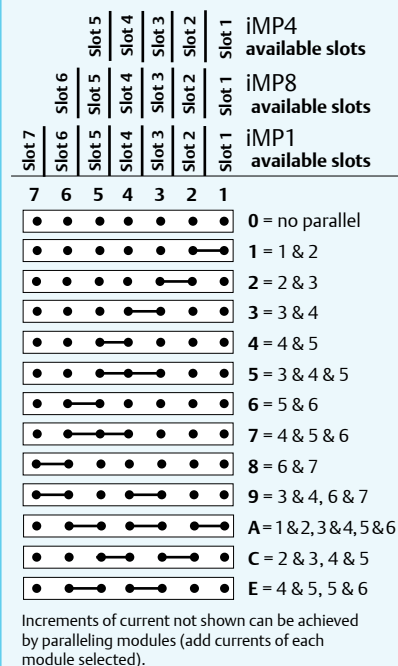

## Ordering Information

Sample below is 1500 W case with 12 V @ 62.5 A; 5 V @ 60 A; 24 V @ 8.5 A; 12 V @ 10 A; 12 V @ 4 A; with no options.

| Case Size  | Module/Voltage/Option Codes<br>First - Module Code<br>Second - Voltage Code<br>Third - Option Code   | Case Option Codes   | Software Code   | Hardware Code   |
|--|--|---|---|---|
| <b>iMP1*</b>   | <b>3L0 - 2E2 - 1Q1 - 4LL0</b>  | <b>00</b>   | <b>A</b>  | <b>###</b>  |
| <p><b>Case Size (mm)</b><br/>                     4 = 2.5" x 5" x 10"; 750-1100 W, 5 slots (63.5 x 127 x 254)<br/>                     8 = 2.5" x 7" x 10"; 1000-1200 W, 6 slots (63.5 x 177.8 x 254)<br/>                     1 = 2.5" x 8" x 11"; 1200-1500 W, 7 slots (63.5 x 203.2 x 279.4)</p> <p>*Note: Add "E" after iMP4 to denote IEC input option. e.g., iMP4E (Not available on iMP8 or iMP1)</p> | <p><b>Module Codes</b><br/>                     Module/voltage/option codes<br/>                     Module codes:<br/>                     (None) = 36 W triple O/P (1 slot)<br/>                     1 = 210 W single O/P (1 slot)<br/>                     2 = 360 W single O/P (2 slot)<br/>                     3 = 750 W single O/P (3 slot)<br/>                     4 = 144 W dual O/P (1 slot)<br/>                     5 = 1500 W single O/P (4 slot)<br/>                     6 - 9 = Future</p> <p><b>Voltage Codes:</b><br/>                     See Output Module Voltage/Current table above</p> <p><b>Option Codes:</b><br/>                     0 = Standard<br/>                     1 = Module enable<br/>                     2 = Constant current<br/>                     3 = 1 &amp; 2 combined<br/>                     4 = Set for use in standard (non-intelligent case)<br/>                     5 = Shutdown mode for 1500 W<br/>                     6 = 1 &amp; 5 combined<br/>                     7 - 9 = Future</p> | <p><b>Case Option Codes</b><br/>                     First digit<br/>                     0 - 9 = parallel code (See Parallel Codes table above)</p> <p>Second digit<br/>                     0 = No options<br/>                     1 = Reverse air<br/>                     3 = Global enable<br/>                     4 = Fan idle w/inhibit<br/>                     5 = Opt 1 + Opt 3<br/>                     6 = Opt 1 + Opt 4<br/>                     7 = Opt 3 + Opt 4<br/>                     8 = Opt 1 + 3 + 4<br/>                     9 = CAN BUS/RS-485 73-544-002<br/>                     B = USB 73-546-002</p> | <p>Software code used for configuration change. "A" is standard</p> | <p>Factory assembled for hardware of firmware mods.</p> |
| <p><b>Ordering Note:</b><br/>                     1. The cases and modules of both MP and iMP series can be interchanged to allow more flexibility. If intelligent modules are used with non-intelligent cases, a numeric code "4" is placed at the end of the module code (e.g., 4LL0 becomes 4LL4).<br/>                     2. USB to I<sup>2</sup>C module order code 73-769-001</p>                     |  |   |   |   |

# Intelligent VS Series

Intelligent modular power supply for optimum flexibility

Up to 4920 Watts

Total Power: Up to 4920 Watts  
 Input Voltage: 85-264 Vac  
 120-300 Vdc  
 # of Outputs: Up to 24



## Special Features

- Medical EN60601-1 approval
- Intelligent I<sup>2</sup>C control
- Voltage adjustment on all outputs (manual or I<sup>2</sup>C)
- Configurable input and output OK signals and indicators
- Configurable inhibit/enable
- Configurable output UP/DOWN sequencing
- High power density (12 W/cu-in)
- Intelligent fan (speed control/fault status)
- $\mu$ P controlled PFC input with active Inrush protection
- I<sup>2</sup>C monitor of voltage, current and temp
- Programmable voltage, current limit, inhibit/enable through I<sup>2</sup>C
- CAN BUS and RS-485 interface option
- Optional extended hold-up module
- (SEMI F47 compliance)
- Increased power density to 150%
- Optional conformal coating
- Industrial temp range (-40 °C to 70 °C)
- Uses standard iMP modules
- Field upgradeable firmware
- RoHS compliant

## Electrical Specifications

| Input                 |   |
|-----------------------|---|
| Input range           |   |
| iVS1 & iVS3:          | 90-264 Vac 1Ø; 120-300 Vdc  |
| iVS6 & iVS8:          | 170-264 Vac 3Ø  |
| Frequency             | 47-440 Hz   |
| Inrush current        | 40 A peak maximum (soft start)  |
| Efficiency            | Up to 85% @ full case load  |
| Power factor          | 0.99 typ. meets EN61000-3-2   |
| Turn-on time          | AC on 1.5 sec typical, inhibit/enable 150 ms typical. Programmable  |
| EMI Filter            | CISPR 22/EN55022 Level "B"  |
| Leakage current       | 300 $\mu$ A max. @ 240 Vac; 47-63 Hz  |
| Radiated EMI          | CISPR 22/EN55022 Level "B"  |
| Holdover storage      | 10 ms minimum (independent of input Vac) additional 20 ms holdover storage with optional HUP module (SEMI F47 compatible) |
| AC OK                 | >5 ms early warning minutes before outputs lose regulation. Full cycle ride thru (50 Hz). Programmable                    |
| Harmonic distortion   | Meets EN61000-3-2   |
| Isolation             | Meets EN60950 and EN60601   |
| Global inhibit/enable | TTL, Logic "1" and Logic "0"/configurable   |
| Warranty              | Three years   |



210 W



360 W



750 W



1500 W

### Single

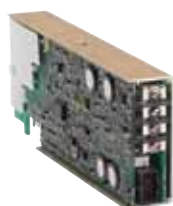

144 W



36 W

### Dual

### Triple



| Output                    |   |
|---------------------------|---|
| Adjustment range*         | ±10% minimum all outputs (manual)<br>(full module adjustment range using I <sup>2</sup> C)  |
| Margining                 | ±4-6% nominal analog (single output module only)  |
| Overall regulation        | 0.4% or 20 mV max. (1500 W modules 1% max.)   |
| Ripple                    | RMS: 0.1% or 10 mV, whichever is greater<br>Pk-Pk: 1.0% or 50 mV, whichever is greater<br>Bandwidth limited to 20 MHz   |
| Dynamic response          | <2% or 100 mV, with 25% load step   |
| Recovery time             | To within 1% in <300 μs   |
| Overcurrent protection**  | Configurable through I <sup>2</sup> C. single output module and main output of the dual output module 105-120% of rated output current. Aux output of dual output module 105-140% of rated output current. Special programmable OCP delay on 1500 W module from 100 ms to 25.5 seconds with shutdown features |
| Short-circuit protection  | Protected for continuous short-circuit<br>Recovery is automatic upon removal of short<br>(Shutdown mode on 1500 W module)   |
| Overvoltage protection*   | Configurable through I <sup>2</sup> C<br>– Single output module 2-5.5 V 122-134%; 6-60 V 110-120%<br>– Dual output module 2-6 V 122-134%; 8-28 V 110-120%<br>– Triple output module No overvoltage protection provided  |
| Thermal protection*       | Configurable through I <sup>2</sup> C<br>All outputs disabled when internal temp exceeds safe operating range. > 5 ms warning (AC OK signal) before shutdown  |
| Remote sense              | Up to 0.5 V total drop (not available on triple output module)  |
| Single wire parallel      | Current share to within 2% of total rated current   |
| DC OK*                    | ±5% of nominal. Configurable through I <sup>2</sup> C   |
| Minimum load              | Not required  |
| Housekeeping bias voltage | 5 Vdc @1.0 A max. present whenever AC input is applied  |
| Module inhibit*           | Configured and controlled through I <sup>2</sup> C  |
| Output/Output isolation   | >1 Megohm, 500 V  |

\* Can be controlled via I<sup>2</sup>C

\*\* Controlled via I<sup>2</sup>C but requires load calibration

## Environmental Specifications

|                                |  |
|--------------------------------|--|
| Operating temperature          | -40 °C to 70 °C ambient.<br>Derate each output 2.5% per degree from 50 °C to 70 °C.<br>(-20 °C start up) |
| Storage temperature            | -40 °C to 85 °C  |
| Electromagnetic susceptibility | Designed to meet EN61000-4;<br>-2, -3, -4, -5, -6, -8, -11 Level 3                                       |
| Humidity                       | Operating; non-condensing<br>10% to 95% RH   |
| Vibration                      | IEC68-2-6 to the levels of IEC721-3-2  |
| MTBF demonstrated              | >550,000 hours at full load,<br>220 Vac and 25 °C ambient conditions                                     |

## Safety

|      |  |
|------|--|
| UL   | UL60950/UL2601                           |
| CSA  | CSA22.2 No. 234 Level 5                  |
| VDE  | EN60950/EN60601-1                        |
| BABT | Compliance to EN60950/<br>EN60601 BS7002 |
| CB   | Certificate and report                   |
| CE   | Mark to LVD                              |

## Output Module Line-up

| Module Code                                | 1      | 2      | 3      | 5      | 4  |  |
|--|--------|--------|--------|--------|--|--|
| Module Type                                | Single | Single | Single | Single | Dual   | Triple   |
| Max output power                           | 210 W  | 360 W  | 750 W  | 1500 W | 144 W  | 36 W   |
| Max output current                         | 35 A   | 60 A   | 150 A  | 300 A  | 10 A   | 2 A  |
| Output voltages available*                 | 2-60 V | 2-60 V | 2-60 V | 3-60 V | 6-15, 24-28; 6-15; 6-15; 6-15;<br>2-6; 2-6, 2-6; 24-28, 24-28;<br>24-28; 2-6 | 8-15, 8-15, 2-6; 8-15, 8-15,<br>8-15; 8-15, 8-15, 18-28; 8-15,<br>18-28, 2-6 |
| Standard voltage increments                | 25     | 25     | 25     | 18     | 16   | 18   |
| Remote sense                               | Yes    | Yes    | Yes    | Yes    | Yes  | Yes  |
| Remote margin*                             | Yes    | Yes    | Yes    | Yes    | No   | No   |
| V-Program - I <sup>2</sup> C Control*      | Yes    | Yes    | Yes    | Yes    | Yes  | Yes  |
| Active Current Share                       | Yes    | Yes    | Yes    | Yes    | Yes  | No   |
| Module Inhibit - I <sup>2</sup> C Control* | Yes    | Yes    | Yes    | Yes    | Yes  | Yes  |
| Module Inhibit - Analog                    | Yes    | Yes    | Yes    | Yes    | No   | No   |
| Overvoltage/Overcurrent protection*        | Yes    | Yes    | Yes    | Yes    | Yes  | Yes  |
| Minimum load required                      | No     | No     | No     | No     | No   | No   |
| Slots occupied in any iMP case             | 1      | 2      | 3      | 4      | 1  | 1  |

\* Programmable



## Output Module Voltage/Current

| Voltage                | Voltage Code | Single Output Module Code |        |        |         | Dual Output** |       | Triple Output |       |       | I <sup>2</sup> C Adjustment Ranges*** |
|------------------------|--------------|---------------------------|--------|--------|---------|---------------|-------|---------------|-------|-------|---------------------------------------|
|                        |              | 1                         | 2      | 3      | 5       | V1            | V2    |               |       |       |                                       |
| 2 V                    | A            | 35 A                      | 60 A   | 150 A  | —       | 10 A          | 10 A  | —             | —     | 2 A   | 1.8-2.2                               |
| 2.2 V                  | B            | 35 A                      | 60 A   | 150 A  | —       | 10 A          | 10 A  | —             | —     | 2 A   | 2.0-2.4                               |
| 3 V                    | C            | 35 A                      | 60 A   | 150 A  | 300 A   | 10 A          | 10 A  | —             | —     | 2 A   | 2.7-3.3                               |
| 3.3 V                  | D            | 35 A                      | 60 A   | 150 A  | 300 A   | 10 A          | 10 A  | —             | —     | 2 A   | 3.0-3.6                               |
| 5 V                    | E            | 35 A                      | 60 A   | 150 A  | 300 A   | 10 A          | 10 A  | —             | —     | 2 A   | 4.5-5.5                               |
| 5.2 V                  | F            | 35 A                      | 60 A   | 144 A  | 288 A   | 10 A          | 10 A  | —             | —     | 2 A   | 4.7-5.7                               |
| 5.5 V                  | G            | 34 A                      | 58 A   | 136 A  | 273 A   | 10 A          | 10 A  | —             | —     | 2 A   | 5.0-6.1                               |
| 6 V                    | H            | 23 A                      | 42 A   | 97.5 A | 250 A   | 10 A*         | 10 A* | —             | —     | 2 A   | 5.4-6.6                               |
| 8 V                    | I            | 20 A                      | 36 A   | 84.4 A | 140 A   | 10 A          | 4 A   | 1 A           | 1 A   | 1 A   | 7.2-8.8                               |
| 10 V                   | J            | 18 A                      | 32 A   | 75 A   | 140 A   | 10 A          | 4 A   | 1 A           | 1 A   | 1 A   | 9.0-11.0                              |
| 11 V                   | K            | 17 A                      | 31 A   | 68 A   | 136.3 A | 10 A          | 4 A   | 1 A           | 1 A   | 1 A   | 9.9-12.1                              |
| 12 V                   | L            | 17 A                      | 30 A   | 62.5 A | 125 A   | 10 A          | 4 A   | 1 A           | 1 A   | 1 A   | 10.8-13.2                             |
| 14 V                   | M            | 14 A                      | 21 A   | 53.5 A | 107 A   | 9 A           | 4 A   | 1 A           | 1 A   | 1 A   | 12.6-15.4                             |
| 15 V                   | N            | 14 A                      | 20 A   | 50 A   | 100 A   | 8 A           | 4 A   | 1 A           | 1 A   | 1 A   | 13.5-16.5                             |
| 18 V                   | O            | 11 A                      | 19 A   | 41.6 A | 83.3 A  | —             | —     | —             | 0.5 A | 0.5 A | 16.2-19.8                             |
| 20 V                   | P            | 10.5 A                    | 18 A   | 37.5 A | 75 A    | —             | —     | —             | 0.5 A | 0.5 A | 18.0-22.0                             |
| 24 V                   | Q            | 8.5 A                     | 15 A   | 30 A   | 62.5 A  | 4 A           | 2 A   | —             | 0.5 A | 0.5 A | 21.6-26.4                             |
| 28 V                   | R            | 6.7 A                     | 11 A   | 26.8 A | 53.5 A  | 3 A           | 2 A   | —             | 0.5 A | 0.5 A | 25.2-30.8                             |
| 30 V                   | S            | 6.5 A                     | 11 A   | 25 A   | 50 A    | —             | —     | —             | —     | —     | 27.0-33.0                             |
| 33 V                   | T            | 6.2 A                     | 10.9 A | 22.7 A | 35.8 A  | —             | —     | —             | —     | —     | 29.7-36.3                             |
| 36 V                   | U            | 5.8 A                     | 10 A   | 20.8 A | 35.8 A  | —             | —     | —             | —     | —     | 32.4-39.6                             |
| 42 V                   | V            | 4.2 A                     | 7.5 A  | 16 A   | 35.7 A  | —             | —     | —             | —     | —     | 37.8-46.2                             |
| 48 V                   | W            | 4 A                       | 7.5 A  | 15.6 A | 31.2 A  | —             | —     | —             | —     | —     | 43.2-52.8                             |
| 54 V                   | X            | 3.7 A                     | 6 A    | 13.9 A | 27.7 A  | —             | —     | —             | —     | —     | 48.6-59.4                             |
| 60 V                   | Y            | 3.5 A                     | 6 A    | 12.5 A | 25 A    | —             | —     | —             | —     | —     | 54.0-66.0                             |
| <b>Consult Factory</b> |              |                           |        |        |         |               |       |               |       |       |                                       |
| Special                | Z            | 35 A                      | 60 A   | 150 A  | —       | —             | 10 A  | —             | —     | —     | 2.3-2.6                               |
| Special                | Z            | 35 A                      | 60 A   | 150 A  | —       | —             | 10 A  | —             | —     | —     | 3.7-4.4                               |
| Special                | Z            | 20 A                      | 36 A   | 80 A   | 140 A   | —             | 8 A   | —             | —     | —     | 6.7-7.1                               |

\* Note: Consult factory for extended range down to 6V.  
 \*\* Total output power on dual model must not exceed 144 W.  
 \*\*\* For single output modules only.

## Ordering Information

Sample below is 3210 W case with 12 V @ 125 A; 24 V @ 8.5 A; 5 V @ 60 A; 12 V @ 10 A and 12 V @ 4 A; with no options.

| Case Size   | Module/Voltage/Option Codes<br>First - Module Code<br>Second - Voltage Code<br>Third - Option Code  | Case Option Codes  | Software Code   | Hardware Code   |
|---|---|--|---|---|
| <b>iVS1</b>   | <b>5L1 - 1Q1 - 2EO - 4LL0</b>   | <b>00</b>  | <b>A</b>  | <b>###</b>  |
| <p><b>Case Size (mm)</b><br/> <b>1-Phase Input</b><br/>                     1 = 5" x 5" x 11"; 1500-3210 W, 9 slots (127 x 127 x 279.4)<br/>                     3 = 5" x 8" x 11"; 1800-4920 W, 14 slots (127 x 203.2 x 279.4)<br/> <b>3-Phase Input*</b><br/>                     6 = 5" x 5" x 11"; 3120 W, 9 slots (127 x 127 x 279.4)<br/>                     8 = 5" x 8" x 11"; 4920 W, 14 slots (127 x 203.2 x 279.4)</p> <p>*3-phase versions not medically approved</p> | <p><b>Module Codes</b><br/>                     Module/voltage/option codes<br/>                     Module Codes:<br/>                     (None) = 36 W triple O/P (1 slot)<br/>                     1 = 210 W single O/P (1 slot)<br/>                     2 = 360 W single O/P (2 slot)<br/>                     3 = 750 W single O/P (3 slot)<br/>                     5 = 1500 W single O/P (slot 4)<br/>                     4 = 144 W dual O/P (1 slot)<br/>                     HUP = Extra 30mS hold-up (1 slot)</p> <p><b>Voltage Codes:</b><br/>                     See Output Module Voltage/Current table above</p> <p><b>Option Codes:</b><br/>                     0 = Standard<br/>                     1 = Module enable<br/>                     2 = Constant current<br/>                     3 = 1 &amp; 2 combined<br/>                     4 = Set for use in standard (non-intelligent case)<br/>                     5 = Shutdown mode for 1500 W<br/>                     6 = 1 &amp; 5 combined<br/>                     7-9 = Future</p> | <p><b>Case Option Codes</b><br/>                     First Digit<br/>                     0 - 9 = Parallel code (See parallel codes table in datasheet)</p> <p>Second Digit<br/>                     0 = No options<br/>                     1 = Reverse air<br/>                     2 = Not used<br/>                     3 = Global enable<br/>                     4 = Fan idle w/inhibit<br/>                     5 = Opt 1 + Opt 3<br/>                     6 = Opt 1 + Opt 4<br/>                     7 = Opt 3 + Opt 4<br/>                     8 = Opt 1 + 3 + 4<br/>                     9 = RS485 73-544-001<br/>                     B = USB 73-546-001<br/>                     C = 9 + 3<br/>                     D = CANBus 73-544-004<br/>                     E = D + 3</p> | <p>Software code used for configuration change. "A" is standard</p> | <p>Factory assembled for hardware of firmware mods.</p> |
| <p><b>Ordering Note:</b><br/>                     1. USB to I<sup>2</sup>C module order code 73-769-001</p>   |   |  |   |   |

# LCM300

Bulk front end

310 Watts

Total Power: 310 W  
 # of Outputs: Single  
 Output: 12 to 60 V  
 Optional 5.0 V standby

NEW!



## Special Features

- 310 W (350W Peak) output power
- Low Cost
- 1.61" x 4.0" x 7.0"
- 7.1 Watts Per Cubic Inch
- Industrial/Medical Safety
- -40 °C to 70 °C with derating
- Optional 5 V @ 2 A Housekeeping
- High Efficiency: 91% @ 230 VAC
- Variable speed "Smart Fans"
- DSP controlled
- PMBus Compliant
- Conformal coat option
- ± 20% adjustment range
- Margin programming
- OR-ing FET
- EMI Class B
- EN61000 Immunity
- RoHS 2
- PMBUS

## Electrical Specifications

| Input                |   |
|----------------------|---|
| Input range          | 90 - 264 Vac (Operating) (127-374 Vdc)<br>115/230 Vac (Nominal)<br>TERMINAL BLOCK |
| Frequency            | 47 - 63 Hz, Nominal 50/60   |
| Input fusing         | Internal 8 A fuses, both lines fused  |
| Inrush current       | ≤ 20 A peak, either hot or cold start   |
| Power factor         | 0.98 typical, meets EN61000-3-2   |
| Harmonics            | Meets IEC 1000-3-2 requirements   |
| Input current        | 5 Arms max input current, at 90 Vac   |
| Hold up time         | 20 ms minimum for Main O/P, at full rated load                                    |
| Efficiency           | > 91% typical at full Load/230 Vac nominal  |
| Leakage current      | < 0.3 mA at 264 Vac   |
| ON/OFF power switch  | N/A   |
| Power line transient | MOV directly after the fuse   |
| Isolation            | PRI-Chassis 2500 Vdc Basic<br>PRI-SEC 2500 Vdc Reinforced<br>SEC-Chassis 500 Vdc  |

## Environmental Specifications

|                       |   |
|-----------------------|---|
| Operating temperature | -40 °C to +70 °C, linear derating to 50% from 50 °C to 70 °C          |
| Storage temperature   | -40 °C to +85 °C  |
| Humidity              | 20 to 90%, non-condensing. Operating. Conformal coat option available |
| Fan noise             | < 45 dBA, 80% load at 40 °C; Fan Off when unit is inhibited           |
| Altitude              | Operating - 16,405 feet (3000m)<br>Storage - 30,000 feet              |
| Shock                 | MIL-STD-810F 516.5, Procedure I, VI. Storage                          |
| Vibration             | MIL-STD-810F 514.5, Cat. 4, 10. Storage                               |

## Safety

|           |  |
|-----------|--|
| UL        | 60950-1<br>508/1598/1433<br>60601-1 Ed 3 |
| CSA       | 60950-1                                  |
| VDE       | 60950-1<br>60601                         |
| China     | CCC                                      |
| CB Scheme | Report/Cert                              |

## Electrical Specifications

| Output                       |                                      |   |
|------------------------------|--------------------------------------|---|
| Output rating                | See ordering information table below | 90-264 Vac  |
| Set point                    | ±0.5%                                | 90-264 Vac  |
| Total regulation range       | Main output ±2%<br>5 Vsb ±1%         | Combined line/load/transient when measured at output terminal   |
| Rated load                   | 310 W maximum                        | Derate linear to 50% from 50 °C to 70 °C  |
| Minimum load                 | Main output @ 0.0 A<br>5 Vsb @ 0.0 A | No loss of regulation   |
| Output noise (PARD)          | 1% max p-p<br>50 mV max p-p          | Main output<br>5 Vsb output<br>Measured with a 0.1 µF ceramic and 10 µF tantalum capacitor on any output, 20 MHz                                |
| Output voltage overshoot     | —                                    | No overshoot/undershoot outside the regulation band during on or off cycle  |
| Transient response           | <300 µs                              | 50% load step @ 1 A/µs<br>Step load valid between 10% to 100% of output rating<br>Recovery time to within 1% of set point at onset of transient |
| Max units in parallel        | —                                    | Up to 10  |
| Short circuit protection     | Protection against damage            | Bounce mode   |
| Remote sense                 | —                                    | Compensation up to 500 mV   |
| Output isolation             | —                                    | Standard per safety requirements  |
| Forced load sharing          | To within 10% of all shared outputs  | Analog sharing control  |
| Overload protection (OCP)    | 105% to 125%<br>120% to 170%         | Main output<br>5 Vsb output   |
| Overvoltage protection (OVP) | 125% to 145%<br>110% to 125%         | 12 V output<br>5 Vsb output   |
| Overtemp protection          | 10-15 °C above safe operating area   | Both PFC and output converter monitored   |

## Ordering Information

| Model Number* | Output | Nominal Output Voltage Set Point | Set Point Tolerance | Adjustment Range | Current |        | Output Ripple P/P (0-50 °C) | Max Continuous Power | Combined Line/ Load Regulation |
|---------------|--------|----------------------------------|---------------------|------------------|---------|--------|-----------------------------|----------------------|--------------------------------|
|               |        |                                  |                     |                  | Min     | Max    |                             |                      |                                |
| LCM300L       | 12 V   | 12 V                             | ±0.5%               | ±0.5%            | 0 A     | 25 A   | 120 mV                      | 310                  | 2%                             |
| LCM300N       | 15 V   | 15 V                             | ±0.5%               | ±0.5%            | 0 A     | 20 A   | 150 mV                      | 310                  | 2%                             |
| LCM300Q       | 24 V   | 24 V                             | ±0.5%               | ±0.5%            | 0 A     | 12.5 A | 240 mV                      | 310                  | 2%                             |
| LCM300U       | 36 V   | 36 V                             | ±0.5%               | ±0.5%            | 0 A     | 8.4 A  | 360 mV                      | 310                  | 2%                             |
| LCM300W       | 48 V   | 48 V                             | ±0.5%               | ±0.5%            | 0 A     | 6.3 A  | 480 mV                      | 310                  | 2%                             |

\* "-T" for terminal block instead of IEC input

\* "-4" for 5 Vsb Option

\* "-N" for Low Noise Fan Option

# LCM600

Bulk front end

600 Watts

Total Power: 600 Watts  
 # of Outputs: Single  
 Output: 3.3-60 V  
 Optional 5.0 V standby

NEW!



## Special Features

- 600 W output power
- Low cost
- 2.4" x 4.5" x 7.5"
- 7.41 W/cu-in
- 5 V SELV standby (housekeeping)
- Industrial/Medical safety
- -40 °C to 70 °C with derating
- 5 V housekeeping
- High efficiency: 89% typical
- Variable speed "Smart Fans"
- DSP controlled front end
- Conformal coat option
- ±20% adjustment range
- Margin programming
- OR-ing FET option
- Terminal block input option

## Electrical Specifications

| Input                |  |
|----------------------|--|
| Input range          | 85-264 Vac (Operating)<br>115/230 Vac (Nominal) Input through standard IEC connector |
| Frequency            | 47-440 Hz, Nominal 50/60   |
| Input fusing         | Internal 10 A fuses, both lines fused  |
| Inrush current       | ≤25 A peak, either hot or cold start   |
| Power factor         | 0.99 typical, meets EN61000-3-2  |
| Harmonics            | Meets IEC 1000-3-2 requirements  |
| Input current        | 8 A RMS max input current, at 100 Vac  |
| Hold up time         | 20 ms minimum for Main O/P, at full rated load                                       |
| Efficiency           | >88% at full load  |
| Leakage current      | <0.3 mA at 264 Vac   |
| ON/OFF power switch  | N/A  |
| Power line transient | MOV directly after the fuse  |



## Environmental Specifications

|                       |  |
|-----------------------|--|
| Operating temperature | -40 °C to +70 °C, linear derating to 50% from 50 °C to 70 °C                               |
| Storage temperature   | -40 °C to 85 °C  |
| Humidity              | 20 to 90%, non-condensing. Operating. Conformal coat option available                      |
| Fan noise             | <45 dBA, 80% load at 30 °C   |
| Altitude              | Operating: Up to 15,000 feet above sea level<br>Storage: Up to 30,000 feet above sea level |
| Shock                 | MIL-STD-810F 516.5, Procedure I, VI. Storage   |
| Vibration             | MIL-STD-810F 514.5, Cat. 4, 10. Storage  |

## Safety

|           |                                     |
|-----------|-------------------------------------|
| UL        | 60950-1<br>508/1598/1433<br>60601-1 |
| CSA       | 60950-1                             |
| VDE       | 60950-1<br>60601                    |
| China     | CCC                                 |
| CB Scheme | Report/Cert                         |

## Electrical Specifications

| Output                       |                                      |   |
|------------------------------|--------------------------------------|---|
| Output rating                | See ordering information table below | 85-264 Vac  |
| Set point                    | ±0.5%                                | 85-264 Vac  |
| Total regulation range       | Main output ±2%<br>5 Vsb ±1%         | Combined line/load/transient when measured at output terminal   |
| Rated load                   | 600 W maximum                        | Derate linear to 50% from 50 °C to 70 °C  |
| Minimum load                 | Main output @ 0.0 A<br>5 Vsb @ 0.0 A | No loss of regulation   |
| Output noise (PARD)          | 1% max p-p<br>50 mV max p-p          | Main output<br>5 Vsb output<br>Measured with a 0.1 µF ceramic and 10 µF tantalum capacitor on any output, 20 MHz                                |
| Output voltage overshoot     | —                                    | No overshoot/undershoot outside the regulation band during on or off cycle  |
| Transient response           | <300 µs                              | 50% load step @ 1 A/µs<br>Step load valid between 10% to 100% of output rating<br>Recovery time to within 1% of set point at onset of transient |
| Max units in parallel        | —                                    | Up to 10  |
| Short circuit protection     | Protection against damage            | Bounce mode   |
| Remote sense                 | —                                    | Compensation up to 500 mV   |
| Output isolation             | —                                    | Standard per safety requirements  |
| Forced load sharing          | To within 10% of all shared outputs  | Analog sharing control  |
| Overload protection (OCP)    | 105% to 125%<br>120% to 170%         | Main output<br>5 Vsb output   |
| Overvoltage protection (OVP) | 125% to 145%<br>110% to 125%         | 12 V output<br>5 Vsb output   |
| Overtemp protection          | 10-15 °C above safe operating area   | Both PFC and output converter monitored   |

## Ordering Information

| Model Number* | Output | Nominal Output Voltage Set Point | Set Point Tolerance | Adjustment Range | Current |        | Output Ripple P/P (0-50 °C) | Combined Line/ Load Regulation |
|---------------|--------|----------------------------------|---------------------|------------------|---------|--------|-----------------------------|--------------------------------|
|               |        |                                  |                     |                  | Min     | Max    |                             |                                |
| LCM600L       | 12 V   | 12 V                             | ±0.5%               | 9.6–14.4 V       | 0 A     | 54 A   | 120 mV                      | 2%                             |
| LCM600N       | 15 V   | 15 V                             | ±0.5%               | 12.0–19.5 V      | 0 A     | 44 A   | 150 mV                      | 2%                             |
| LCM600Q       | 24 V   | 24 V                             | ±0.5%               | 19.2–28.8 V      | 0 A     | 27 A   | 240 mV                      | 2%                             |
| LCM600U       | 36 V   | 36 V                             | ±0.5%               | 28.8–43.2 V      | 0 A     | 16.7 A | 240 mV                      | 2%                             |
| LCM600W       | 48 V   | 48 V                             | ±0.5%               | 38.4–57.6 V      | 0 A     | 14 A   | 280 mV                      | 2%                             |

\* "-T" for terminal block instead of IEC input

\* "-4" for 5 Vsb Option

\* "-N" for Low Noise Fan Option

# LCM1500

Bulk front end

1500 Watts

Total Power: 1500 W  
 # of Outputs: Single  
 Output: 12 to 60 V  
 Optional 5.0 V standby

NEW!



RoHS

## Special Features

- 1500 W output power
- Low Cost
- 2.5" x 5.2" x 10.0"
- 12 Watts Per Cubic Inch
- Industrial/Medical safety
- -40 °C to 70 °C with derating
- Optional 5 V @ 2 A Housekeeping
- High Efficiency: 89% typical
- Variable speed "Smart Fans"
- DSP controlled
- Conformal coat option
- ±10% adjustment range
- Margin programming
- OR-ing FET
- Compliance
  - EMI Class B
  - EN61000 Immunity
  - RoHS 2
  - PMBUS

## Electrical Specifications

| Input                |  |
|----------------------|--|
| Input range          | 90 - 264 Vac (Operating)<br>115/230 Vac (Nominal)<br>TERMINAL BLOCK              |
| Frequency            | 47 - 440 Hz, Nominal 50/60   |
| Input fusing         | Internal 20 A fuses, both lines fused  |
| Inrush current       | ≤ 25 A peak, either hot or cold start  |
| Power factor         | 0.99 typical, meets EN61000-3-2  |
| Harmonics            | Meets IEC 1000-3-2 requirements  |
| Input current        | 18 Arms max input current, at 100 Vac  |
| Hold up time         | 20 ms minimum for Main O/P, at full rated load                                   |
| Efficiency           | > 91% typical at full Load/230 Vac nominal                                       |
| Leakage current      | < 0.3 mA at 264 Vac  |
| ON/OFF power switch  | N/A  |
| Power line transient | MOV directly after the fuse  |
| Isolation            | PRI-Chassis 2500 Vdc Basic<br>PRI-SEC 2500 Vdc Reinforced<br>SEC-Chassis 500 Vdc |

## Environmental Specifications

|                       |   |
|-----------------------|---|
| Operating temperature | -40 °C to +70 °C, linear derating to 50% from 50 °C to 70 °C          |
| Storage temperature   | -40 °C to +85 °C  |
| Humidity              | 20 to 90%, non-condensing. Operating. Conformal coat option available |
| Fan noise             | < 45 dBA, 80% load at 30 °C   |
| Altitude              | Operating - 16,405 feet (3000m)<br>Storage - 30,000 feet              |
| Shock                 | MIL-STD-810F 516.5, Procedure I, VI. Storage                          |
| Vibration             | MIL-STD-810F 514.5, Cat. 4, 10. Storage                               |

## Safety

|           |  |
|-----------|--|
| UL        | 60950-1<br>508/1598/1433<br>60601-1 Ed 3 |
| CSA       | 60950-1                                  |
| VDE       | 60950-1<br>60601                         |
| China     | CCC                                      |
| CB Scheme | Report/Cert                              |

## Electrical Specifications

| Output                       |                                      |   |
|------------------------------|--------------------------------------|---|
| Output rating                | See ordering information table below | 90-264 Vac  |
| Set point                    | ±0.5%                                | 90-264 Vac  |
| Total regulation range       | Main output ±2%<br>5 Vsb ±1%         | Combined line/load/transient when measured at output terminal   |
| Rated load                   | 1500 W maximum                       | Derate linear to 50% from 50 °C to 70 °C  |
| Minimum load                 | Main output @ 0.0 A<br>5 Vsb @ 0.0 A | No loss of regulation   |
| Output noise (PARD)          | 1% max p-p<br>50 mV max p-p          | Main output<br>5 Vsb output<br>Measured with a 0.1 µF ceramic and 10 µF tantalum capacitor on any output, 20 MHz                                |
| Output voltage overshoot     | —                                    | No overshoot/undershoot outside the regulation band during on or off cycle  |
| Transient response           | <300 µs                              | 50% load step @ 1 A/µs<br>Step load valid between 10% to 100% of output rating<br>Recovery time to within 1% of set point at onset of transient |
| Max units in parallel        | —                                    | Up to 10  |
| Short circuit protection     | Protection against damage            | Bounce mode   |
| Remote sense                 | —                                    | Compensation up to 500 mV   |
| Output isolation             | —                                    | Standard per safety requirements  |
| Forced load sharing          | To within 10% of all shared outputs  | Analog sharing control  |
| Overload protection (OCP)    | 105% to 125%<br>120% to 170%         | Main output<br>5 Vsb output   |
| Overvoltage protection (OVP) | 125% to 145%<br>110% to 125%         | 12 V output<br>5 Vsb output   |
| Overtemp protection          | 10-15 °C above safe operating area   | Both PFC and output converter monitored   |

## Ordering Information

| Model Number* | Output | Nominal Output Voltage Set Point | Set Point Tolerance | Adjustment Range | Current |        | Output Ripple P/P (0-50 °C) | Max Continuous Power | Combined Line/Load Regulation |
|---------------|--------|----------------------------------|---------------------|------------------|---------|--------|-----------------------------|----------------------|-------------------------------|
|               |        |                                  |                     |                  | Min     | Max    |                             |                      |                               |
| LCM1500L      | 12 V   | 12 V                             | ±0.5%               | 10.8–13.2 V      | 0 A     | 133 A  | 120 mV                      | 1500                 | 2%                            |
| LCM1500N      | 15 V   | 15 V                             | ±0.5%               | 13.5–16.5 V      | 0 A     | 100 A  | 150 mV                      | 1500                 | 2%                            |
| LCM1500Q      | 24 V   | 24 V                             | ±0.5%               | 21.6–26.4 V      | 0 A     | 67 A   | 240 mV                      | 1500                 | 2%                            |
| LCM1500R      | 28 V   | 28 V                             | ±0.5%               | 25.2–30.8 V      | 0 A     | 53.6 A | 280 mV                      | 1500                 | 2%                            |
| LCM1500U      | 36 V   | 36 V                             | ±0.5%               | 32.4–39.6 V      | 0 A     | 43 A   | 360 mV                      | 1500                 | 2%                            |
| LCM1500W      | 48 V   | 48 V                             | ±0.5%               | 43.2–52.8 V      | 0 A     | 33 A   | 480 mV                      | 1500                 | 2%                            |

\* "-T" for terminal block instead of IEC input

\* "-4" for 5 Vsb Option

\* "-N" for Low Noise Fan Option



# HPS & UFE

Distributed power bulk front end

3000-12000 Watts

## Special Features

- EN61000-3-2 harmonic compliance
- Built-in EMI filter
- Low output ripple
- +5 V standby output
- Built-in cooling fans
- Hot swap/N + 1 redundant
- Overcurrent protection
- Overvoltage protection
- Overtemperature protection
- Built-in OR-ing diodes
- Active power factor correction



## Voltage Availability

| Model  | HPS3000                   | UFE                 |
|--|---------------------------|---------------------|
| Wattage  | 3000 W <sup>3</sup>       | 2000 W <sup>4</sup> |
| Input Voltage  | 90-140 Vac<br>180-264 Vac | 90-265 Vac          |
| <b>Available Standard Output Voltages (order code)<sup>1</sup></b> |                           |                     |
| 12 (L)   |                           |                     |
| 24 (Q)   |                           | •                   |
| 28 (R)   |                           | •                   |
| 30 (S)   |                           |                     |
| 48 (W)   | •                         | •                   |
| 54 (X)   |                           | •                   |
| 60 (Y)   |                           |                     |
| Available Options  | See Note 1                |                     |
| Corresponding Rack   | See Note 2                | UFR6000J            |

Notes: 1 = Consult factory for other output voltages and options  
 2 = Comes with optional I<sup>2</sup>C interface  
 3 = 3000 W @ 180-264 Vac; 1500 W @ 90-140 Vac  
 4 = 2000 W @ 48 V; 1300 W @ 24 V

## HPS3000 Electrical Specifications

| Input                   |  |
|-------------------------|--|
| Input range (operating) | 180-264 Vac<br>90-140 Vac                  |
| Input range (nominal)   | 200 Vac<br>110 Vac                         |
| Frequency               | 43-63 Hz                                   |
| Input fusing            | Internal 25 A fuses (both lines fused)     |
| Inrush current          | ≤40 A peak (either hot or cold start)      |
| Power factor            | 0.97 typical (Meets EN61000-3-2)           |
| Harmonics               | Meets IEC 1000-3-2 requirements @ 50% load |
| Input current           | 19 A max input current                     |
| Holdup time             | 10 ms min @ full rated load                |
| Leakage current         | 1.4 mA @ 240 Vac                           |
| Power line transient    | MOV directly after the fuse                |

## Environmental Specifications

| HPS3000         |   |
|-----------------|---|
| Operating temp. | -10 °C to 40 °C   |
| Storage temp.   | -40 °C to 85 °C   |
| Cooling         | External fans with Fan Fail and Fan Speed control   |
| Humidity        | Operating/Storage: 5-95% non-condensing   |
| Altitude        | Operating: Up to 10,000 feet above sea level<br>Storage: Up to 30,000 feet above sea level      |
| Vibration/Shock | Non-operational 5G Sine sweep from 5-500 Hz, dwelling at resonant frequencies for one hour each |
| RoHS compliant  | Yes   |

## Safety

|       |                         |
|-------|-------------------------|
| UL    | UL60950 (UL recognized) |
| NEMKO | EN60950                 |
| TÜV   | EN60950                 |
| CE    | Mark                    |
| CB    | Report                  |



HPR12K



| Output                       |  |
|------------------------------|--|
| Output rating                | 48 V @ 62.0 A (180-264 Vac)<br>5 Vsb @ 3.0 A<br>48 V @ 29.4 A (90-140 Vac)<br>5 V @ 3 A  |
| Set point                    | -4% to +17% through I <sup>2</sup> C   |
| Total regulation range       | 48 V ±10%; 5 Vsb ±4% (line/load/transient when measured at output connection)  |
| Rated load                   | 3000 W maximum @ 200 Vac Input<br>1500 W maximum @ 110 Vac Input<br>(no derating over operating temperature range)   |
| Minimum load                 | 48 V @ 0.0 A; 5 Vsb @ 0.0 A with no loss of regulation   |
| Output noise                 | 480 mV max P-P for 48 V output<br>100 mV max P-P for 5 Vsb output<br>Measured with a 0.1µF Ceramic and 10 µF Tantalum capacitor on any input                     |
| Output voltage overshoot     | ±5% maximum of nominal voltage setting   |
| Transient response           | 5% maximum deviation<br>(50% load step @ 1 A/us. Step load valid between 10-100% of output rating)   |
| Max units in parallel        | Up to 4 (total power in 1U 19" rack is 12 KW)  |
| Short circuit protection     | 120-130% of rated output (output to return)  |
| Output isolation             | Per POE specs (>2000 Vac)  |
| Forced load sharing          | Within 10% of all shared outputs (digital sharing control)   |
| Overcurrent protection (OCP) | 120-130% for 48 V output<br>100-125% for 5 Vsb output  |
| Overvoltage protection (OVP) | 110-120% for 48 V output<br>110-125% for 5 Vsb output  |
| Overtemperature protection   | 10 °C to 15 °C above safe operating area.<br>(Both PFC and output converter monitored. 5 Vsb will operate under overtemperature condition. Built-in hysteresis.) |

### Rack Ordering Information

| Module      | UFE1300/2000 | HPS3000 |
|-------------|--------------|---------|
| Rack #      | UFR6000      | HPR12K  |
| # of Slots  | 3            | 4       |
| Total Power | 6000 W       | 12000 W |

\*\* See website for option codes on HPR racks.

### Ordering Information

|               |               |
|---------------|---------------|
| HPS3000-0-001 | HPS3000-0-001 |
| HPS3000       | HPS3000-9     |

## UFE1300/2000 Electrical Specifications

| Input                             |  |
|-----------------------------------|--|
| Input range (operating)           | 88-264 Vac<br>176-264 Vac                                  |
| Input range (nominal)             | 120 Vac<br>240 Vac   |
| Frequency                         | 47-63 Hz   |
| Input fusing                      | 30 A (both lines fused)                                    |
| Power factor                      | 0.98 (50-100% load)  |
| Input current                     | 15 A max.  |
| Leakage current                   | 2 mA max.  |
| Undervoltage lockout (power up)   | 176 Vac max. (high line range)<br>88 Vac max. (wide range) |
| Undervoltage lockout (power down) | 162 Vac min. (high line range)<br>76 Vac min. (wide range) |

| Output                                 |   |
|--|---|
| Output rating - Main output            | 48 V 2000 W (high line range)<br>48 V 1300 W (wide range)<br>24 V 1300 W (all ranges) |
| Output rating - Auxiliary output       | 11 V $\pm$ 15%, 2.875 W   |
| Line regulation                        | $\pm$ 0.15% max.  |
| Load regulation                        | $\pm$ 0.15% max.  |
| Turn-on delay                          | 5.0 seconds max.  |
| Ambient temp. coefficient              | $\pm$ 0.005%/°C   |
| Voltage adjustability (via PMBus)      | 48 V 42-57 Vdc<br>24 V 21-28.5 Vdc  |
| Output setpoint accuracy               | $\pm$ 0.5%  |
| Default output voltage (@ 25 °C)       | 48 V $\pm$ 0.5% @ 41 A<br>27 V $\pm$ 0.5% @ 48 A                                      |
| Total error band                       | $\pm$ 1.0% max.   |
| Overshoot/undershoot                   | 0%  |
| Ripple and noise (20 MHz)              | 500 mV pk-pk, 150 mV rms  |
| Dynamic regulation (except droop mode) | 2.5% max., recovery in 1 ms max.  |
| Current sharing                        | 15% max.  |
| Electrical insulation                  | 4242 Vdc input/output   |
| Switching frequency                    | 450 kHz fixed   |
| Power limit                            | 115%  |
| Current limit                          | 108% typical  |
| Short-circuit                          | 200 ms on; 1/8 second off   |
| Overshoot                              | 60 V/32 V   |
| Overtemperature                        | Non-latching  |

UFE Power Shelf



UFE2000

## Ordering Information

| Rated Output Power    | Output Voltage Vout |        | Output Current (Min) | Power Limit + 15% / -0% Vout (min) | Line Range at Turn On (Auto Ranging) | Operating Line Range | Current Limit (Vout) < Vout (min) | Model Numbers     | Order Number |
|-----------------------|---------------------|--------|----------------------|------------------------------------|--------------------------------------|----------------------|-----------------------------------|-------------------|--------------|
|                       | Min                 | Max    |                      |                                    |                                      |                      |                                   |                   |              |
| <b>24 Vout Models</b> |                     |        |                      |                                    |                                      |                      |                                   |                   |              |
| 1300 W                | 21 V                | 28.5 V | 0 A                  | 1300 W                             | 90-264 Vac                           | 65 A                 | 65 A                              | UFE1300-96S24PJ   | UFE1300-5    |
| <b>48 Vout Models</b> |                     |        |                      |                                    |                                      |                      |                                   |                   |              |
| 1300 W                | 42 V                | 57 V   | 0 A                  | 1300 W                             | 90-264 Vac                           | 33 A                 | 33 A                              | UFE2000-96S48PJ   | UFE2000-9    |
| 2000 W                | 42 V                | 57 V   | 0 A                  | 2000 W                             | 180-264 Vac                          | 52 A                 | 52 A                              |                   |              |
| 1300 W                | 42 V                | 57 V   | 0 A                  | 1300 W                             | 90-264 Vac                           | 33 A                 | 33 A                              | UFE2000-96S48PDJ  | UFE2000-9-HD |
| 2000 W                | 42 V                | 57 V   | 0 A                  | 2000 W                             | 180-264 Vac                          | 52 A                 | 52 A                              |                   |              |
| 1300 W                | 42 V                | 57 V   | 0 A                  | 1300 W                             | 90-264 Vac                           | 33 A                 | 33 A                              | UFE2000-96S48PHDJ | UFE2000-9-D  |
| 2000 W                | 42 V                | 57 V   | 0 A                  | 2000 W                             | 180-264 Vac                          | 52 A                 | 52 A                              |                   |              |

| Product Family            | Rated Output Power                     | Input Range                  | Standard Compliance      | Type of Output | Output Voltage         | Communications Type             | Option Code  | Special Modification | RoHS Compliance                  |
|---------------------------|--|------------------------------|--------------------------|----------------|------------------------|---------------------------------|--|----------------------|----------------------------------|
| <b>UFE</b>                | <b>2000</b>                            | <b>9</b>                     | <b>6</b>                 | <b>S</b>       | <b>48</b>              | <b>P</b>                        | <b>D</b>   | <b>xx</b>            | <b>J</b>                         |
| UFE = Universal Front-End | 1300 = 1300 Watts<br>2000 = 2000 Watts | 9 = Universal Input with PFC | 6 = UL/CSA/VDE Class A/B | S = Single     | 48 = 48 V<br>24 = 24 V | P = PMBus serial communications | None = Active Ishare<br>D = Droop Ishare<br>HD = PS Enable<br>HI/Droop |                      | J = Pb free (RoHS 6/6 compliant) |

# Distributed Power Systems (DS)

AC and DC inputs available

450-2900 Watts



DS450DC/DS2900



## Special Features

- Active power factor correction
- EN61000-3-2 harmonic compliance
- Active AC inrush control
- High density
- Outputs +12 Vdc with some +48 Vdc models available
- 3.3 Vdc standby
- Options for 5 V standby voltage
- No minimum load required
- Hot plug operation
- N+1 redundant
- Internal OR-ing FETs
- Active current sharing
- Built-in cooling fans
- I<sup>2</sup>C Interface with EEPROM for FRU data
- Internal fan speed control with fan fail signal
- DC Input
- DSR1 rack for DS650/850. Ordering part number is 73-762-002. Standard 19" 1U fits up to 5 modules (4250 Watts)
- Gold efficiency standards on some models
- Options for reverse airflow
- Options for 5 V standby
- Platinum Plus efficiency on some models

## Voltage Availability

| Model      | 12 V | 24 V | 48 V | PMBus |
|------------|------|------|------|-------|
|            | (-3) | (-5) | (-9) |       |
| DS450 (HE) | •    |      |      |       |
| DS450DC    | •    |      |      |       |
| DS460S     | •    |      |      | •     |
| DS460SDC   | •    |      |      | •     |
| DS550 (HE) | •    |      |      |       |
| DS550DC    | •    |      |      |       |
| DS650      | •    | •    | •    |       |
| DS650DC    | •    |      |      |       |
| DS750PED   | •    |      |      |       |
| DS760SL    | •    |      |      |       |
| DS800SL    | •    |      |      | •     |
| DS850      | •    | •    | •    |       |
| DS850DC    | •    |      |      |       |
| DS1050     | •    |      |      | •     |
| DS1100PED  | •    |      |      |       |
| DS1200     | •    |      |      | •     |
| DS1200DC   | •    |      |      | •     |
| DS1500     | •    |      |      |       |
| DS2000     | •    |      |      | •     |
| DS2900     | •    |      |      | •     |

Notes: • Available

## Safety

|       |                         |
|-------|-------------------------|
| UL    | UL60950 (UL recognized) |
| NEMKO | EN60950                 |
| TÜV   | EN60950                 |
| CE    | Mark                    |
| CB    | Report                  |





## Electrical Specifications

**NEW!**

|                            | DS450-3             | DS450DC-3           | DS460S-3          | DS460SDC          | DS500SPE-3         | DS550-3             |
|----------------------------|---------------------|---------------------|-------------------|-------------------|--------------------|---------------------|
| <b>Input</b>               |                     |                     |                   |                   |                    |                     |
| Input Range                | 90-264 Vac          | 40-72 Vdc           | 90-264 Vac        | 40-72 Vdc         | 90-264 Vac         | 90-264 Vac          |
| Frequency                  | 47-63 Hz            | DC                  | 47-63 Hz          | DC                | 47-63 Hz           | 47-63 Hz            |
| Efficiency                 | 80% Typ             | 80% Typ             | 92% Typ           | 92% Typ           | 94% Typ            | 80% Typ             |
| EMI/RFI                    | Class B             | N/A                 | Class B           | N/A               | Class A            | Class B             |
| Leakage Current            | 1.4 mA @ 240 V      | N/A                 | 1.0 mA @ 240 V    | N/A               | 1.75 mA @ 240 V    | 1.4 mA @ 240 V      |
| <b>Outputs</b>             |                     |                     |                   |                   |                    |                     |
| Output Main                | 12 V / 37 A         | 12 V / 37 A         | 12 V / 38.2 A     | 12 V / 38.2 A     | 12 V / 41.6 A      | 12 V / 45 A         |
| Output Stand-By            | 3.3 Vsb / 3 A       | 3.3 Vsb / 3 A       | 12 Vsb / 2.5 A    | 12 Vsb / 2.5 A    | 12 V / 4.5 A       | 3.3 Vsb / 3 A       |
| OCP/OVP/OTP                | YES                 | YES                 | YES               | YES               | YES                | YES                 |
| I <sup>2</sup> C Control   | YES                 | YES                 | YES               | YES               | YES                | YES                 |
| <b>Environmental</b>       |                     |                     |                   |                   |                    |                     |
| Operating Temp             | -10 °C to 50 °C     | -10 °C to 50 °C     | -10 °C to 50 °C   | -10 °C to 50 °C   | 0 °C to 50 °C      | -10 °C to 50 °C     |
| Derating                   | N/A                 | N/A                 | N/A               | N/A               | 50 °C to 70 °C     | N/A                 |
| Storage                    | -40 °C to +85 °C    | -40 °C to +85 °C    | -40 °C to +85 °C  | -40 °C to +85 °C  | -40 °C to +85 °C   | -40 °C to +85 °C    |
| RoHS Compliant             | YES                 | YES                 | YES               | YES               | YES                | YES                 |
| MTBF                       | 300K Hours          | 500K Hours          | 500K Hours        | 500K Hours        | 200K Hours         | 300K Hours          |
| <b>Other</b>               |                     |                     |                   |                   |                    |                     |
| Size (inch)                | 1.57 x 3.07 x 11.05 | 1.57 x 3.07 x 11.05 | 1.57 x 3.4 x 7.75 | 1.57 x 3.4 x 7.75 | 1.57 x 3.39 x 7.73 | 1.57 x 3.07 x 11.05 |
| Size (mm)                  | 40 x 78 x 280       | 40 x 78 x 280       | 40 x 86.4 x 197   | 40 x 86.4 x 197   | 40 x 86.3 x 196.5  | 40 x 78 x 280       |
| Power Density              | 8.42                | 8.42                | 11.12             | 11.12             | 12.15362178        | 10.30               |
| Cubic Inches               | 53.42               | 53.42               | 41.37             | 41.37             | 41.14              | 53.42               |
| Pro-E Files                | NO                  | YES                 | YES               | YES               | YES                | NO                  |
| Thermal Data               | YES                 | YES                 | YES               | YES               | YES                | YES                 |
| PQ Airflow Curves          | YES                 | YES                 | YES               | YES               | YES                | YES                 |
| Warranty                   | Two Years           | Two Years           | Two Years         | Two Years         | Two Years          | Two Years           |
| <b>Ordering Codes</b>      |                     |                     |                   |                   |                    |                     |
| Standard                   | DS450-3             | DS450DC-3           | DS460S-3-002      | DS460SDC-3        | DS500SPE-3         | DS550-3             |
| ALT Standby                | DS450-3-001         |                     |                   |                   |                    |                     |
| Reverse Air                | DS450-3-002         | DS450DC-3-002       | DS460S-3-003      | DS460SDC-3-001    | DS500SPE-3-001     |                     |
| ALT Standby & Reverse Air  |                     |                     |                   |                   |                    |                     |
| Fan Off with inhibit       |                     |                     |                   |                   |                    |                     |
| Disable External Fan Drive | DS450-3-003         |                     |                   |                   |                    |                     |



DS550DC



DS650/DS850



DS750PED

**NEW!**

|                            | DS550DC-3           | DS650-3             | DS650-5             | DS650-9             | DS650DC-3           | DS750PED-3         |
|----------------------------|---------------------|---------------------|---------------------|---------------------|---------------------|--------------------|
| <b>Input</b>               |                     |                     |                     |                     |                     |                    |
| Input Range                | 40-72 Vdc           | 90-264 Vac          | 90-264 Vac          | 90-264 Vac          | 40-72 Vdc           | 90-264 Vac         |
| Frequency                  | DC                  | 47-63 Hz            | 47-63 Hz            | 47-63 Hz            | DC                  | 47-63 Hz           |
| Efficiency                 | 80% Typ             | 80% Typ             | 80% Typ             | 82% Typ             | 80% Typ             | 94% Typ            |
| EMI/RFI                    | N/A                 | Class B             | Class B             | Class B             | N/A                 | Class A            |
| Leakage Current            | N/A                 | 1.4 mA @ 240 V      | 1.4 mA @ 240 V      | 1.4 mA @ 240 V      | N/A                 | 1.75 mA @ 240 V    |
| <b>Outputs</b>             |                     |                     |                     |                     |                     |                    |
| Output Main                | 12 V / 45 A         | 12 V / 52.5 A       | 24 V / 26.3 A       | 48 V / 13.1 A       | 12 V / 52.5 A       | 12 V / 62.5 A      |
| Output Stand-By            | 3.3 Vsb / 3 A       | 3.3 Vsb / 6 A       | 3.3 Vsb / 6 A       | 3.3 Vsb / 6 A       | 3.3 Vsb / 6 A       | 12 V / 3 A         |
| OCP/OVP/OTP                | YES                 | YES                 | YES                 | YES                 | YES                 | YES                |
| I <sup>2</sup> C Control   | YES                 | YES                 | YES                 | YES                 | YES                 | YES                |
| <b>Environmental</b>       |                     |                     |                     |                     |                     |                    |
| Operating Temp             | -10 °C to 50 °C     | -10 °C to 50 °C     | -10 °C to 50 °C     | -10 °C to 50 °C     | -10 °C to 50 °C     | 10 °C to 50 °C     |
| Derating                   | N/A                 | 50% at 70 °C        | 50% at 70 °C        | 50% at 70 °C        | 50% at 70 °C        | N/A                |
| Storage                    | -40 °C to +85 °C    | -40 °C to +85 °C    | -40 °C to +85 °C    | -40 °C to +85 °C    | -40 °C to +85 °C    | -40 °C to +70 °C   |
| RoHS Compliant             | YES                 | YES                 | YES                 | YES                 | YES                 | YES                |
| MTBF                       | 500K Hours          | 500K Hours          | 500K Hours          | 500K Hours          | 500K Hours          | 200K Hours         |
| <b>Other</b>               |                     |                     |                     |                     |                     |                    |
| Size (inch)                | 1.57 x 3.07 x 11.05 | 1.57 x 3.20 x 11.00 | 1.57 x 3.20 x 11.00 | 1.57 x 3.20 x 11.00 | 1.57 x 3.20 x 11.00 | 1.57 x 3.39 x 7.74 |
| Size (mm)                  | 40 x 78 x 280       | 40 x 81.3 x 279.4   | 40 x 81.3 x 279.4   | 40 x 81.3 x 279.4   | 40 x 81.3 x 279.4   | 41 x 86.3 x 196.5  |
| Power Density              | 10.30               | 11.76               | 11.76               | 11.76               | 11.76               | 18.23043267        |
| Cubic Inches               | 53.42               | 55.44               | 55.44               | 55.44               | 55.44               | 41.14              |
| Pro-E Files                | YES                 | YES                 | YES                 | YES                 | YES                 | YES                |
| Thermal Data               | YES                 | YES                 | YES                 | YES                 | YES                 | YES                |
| PQ Airflow Curves          | YES                 | YES                 | YES                 | YES                 | YES                 | YES                |
| Warranty                   | Two Years           | Two Years           | Two Years           | Two Years           | Two Years           | Two Years          |
| <b>Ordering Codes</b>      |                     |                     |                     |                     |                     |                    |
| Standard                   | DS550DC-3           | DS650-3             | DS650-5             | DS650-9             | DS650DC-3           | DS750PED-3         |
| ALT Standby                | DS550DC-3-004       |                     |                     | DS650-9-002         | DS650DC-3-002       |                    |
| Reverse Air                | DS550DC-3-003       | DS650-3-007         |                     | DS650-9-004         | DS650DC-3-003       | DS750PED-3-001     |
| ALT Standby & Reverse Air  |                     |                     |                     | DS650-9-005         | DS650DC-3-004       |                    |
| Fan Off with inhibit       |                     |                     |                     |                     |                     |                    |
| Disable External Fan Drive |                     |                     | DS650DC-3-001       |                     | DS850DC-3-001       |                    |



DS760SL



DS800SL



DS850

|                            | DS760SL-3           | DS800SL-3           | DS850-3             | DS850-5             | DS850-9             |
|----------------------------|---------------------|---------------------|---------------------|---------------------|---------------------|
| <b>Input:</b>              |                     |                     |                     |                     |                     |
| Input Range                | 90-264 Vac          | 90-264 Vac          | 90-264 Vac          | 90-264 Vac          | 90-264 Vac          |
| Frequency                  | 47-63 Hz            | 47-63 Hz            | 47-63 Hz            | 47-63 Hz            | 47-63 Hz            |
| Efficiency                 | 90% Typ             | 92% Typ GLD         | 82% Typ             | 82% Typ             | 83% Typ             |
| EMI/RFI                    | Class A             | Class A             | Class B             | Class B             | Class B             |
| Leakage Current            | 0.8 mA @240 V       | 0.8 mA @240 V       | 1.4 mA @ 240 V      | 1.4 mA @ 240 V      | 1.4 mA @ 240 V      |
| <b>Outputs</b>             |                     |                     |                     |                     |                     |
| Output Main                | 12 V / 62.3 A       | 12 V / 66.7 A       | 12 V / 70 A         | 24 V / 35 A         | 48 V / 17.5 A       |
| Output Stand-By            | 5.0 Vsb / 3.6 A     | 5.0 Vsb / 4 A       | 3.3 Vsb / 6 A       | 3.3 Vsb / 6 A       | 3.3 Vsb / 6 A       |
| OCP/OVP/OTP                | YES                 | YES                 | YES                 | YES                 | YES                 |
| I <sup>2</sup> C Control   | YES                 | YES                 | YES                 | YES                 | YES                 |
| <b>Environmental</b>       |                     |                     |                     |                     |                     |
| Operating Temp             | 0 °C to 50 °C       | 0 °C to 50 °C       | -10 °C to 50 °C     | -10 °C to 50 °C     | -10 °C to 50 °C     |
| Derating                   | N/A                 | N/A                 | 50% at 70 °C        | 50% at 70 °C        | 50% at 70 °C        |
| Storage                    | -40 °C to +85 °C    | -40 °C to +85 °C    | -40 °C to +85 °C    | -40 °C to +85 °C    | -40 °C to +85 °C    |
| RoHS Compliant             | YES                 | YES                 | YES                 | YES                 | YES                 |
| MTBF                       | 300K Hours          | 500K Hours          | 500K Hours          | 500K Hours          | 500K Hours          |
| <b>Other:</b>              |                     |                     |                     |                     |                     |
| Size (inch)                | 1.57 x 2.15 x 12.68 | 1.57 x 2.15 x 12.68 | 1.57 x 3.20 x 11.00 | 1.57 x 3.20 x 11.00 | 1.57 x 3.20 x 11.00 |
| Size (mm)                  | 40 x 54.5 x 322     | 40 x 54.5 x 322     | 40 x 81.3 x 279.4   | 40 x 81.3 x 279.4   | 40 x 81.3 x 279.4   |
| Power Density              | 17.76               | 18.69               | 15.38               | 15.38               | 15.38               |
| Cubic Inches               | 42.8                | 42.8                | 55.44               | 55.44               | 55.44               |
| Pro-E Files                | YES                 | YES                 | YES                 | YES                 | YES                 |
| Thermal Data               | YES                 | YES                 | YES                 | YES                 | YES                 |
| PQ Airflow Curves          | YES                 | YES                 | YES                 | YES                 | YES                 |
| Warranty                   | Two Years           | Two Years           | Two Years           | Two Years           | Two Years           |
| <b>Ordering Codes</b>      |                     |                     |                     |                     |                     |
| Standard                   | DS760SL-3           | DS800SL-3           | DS850-3             | DS850-5             | DS850-9             |
| ALT Standby                | DS760SL-3-002       |                     | DS850-3-002         | DS850-5-001         | DS850-9-002         |
| Reverse Air                | DS760SL-3-001       | DS800SL-3-001       | DS850-3-006         | DS850-5-002         | DS850-9-003         |
| ALT Standby & Reverse Air  | DS760SL-3-003       |                     | DS850-3-008         | DS850-5-003         | DS850-9-004         |
| Fan Off with inhibit       |                     |                     |                     |                     |                     |
| Disable External Fan Drive |                     |                     |                     |                     |                     |



DS850DC



DS1100PED



DS1200

**NEW!**

|                            | DS850DC-3           | DS1050-3            | DS1100PED-3        | DS1200-3            | DS1200DC-3          |
|----------------------------|---------------------|---------------------|--------------------|---------------------|---------------------|
| <b>Input:</b>              |                     |                     |                    |                     |                     |
| Input Range                | 40-72 Vdc           | 90-264 Vac          | 90-264 Vdc         | 90-264 Vac          | 40-72 Vdc           |
| Frequency                  | DC                  | 47-63 Hz            | 47-63 Hz           | 47-63 Hz            | DC                  |
| Efficiency                 | 80% Typ             | 92% Typ GLD         | 94% Typ            | 90% Typ             | 91% Typ             |
| EMI/RFI                    | N/A                 | Class B             | Class A            | Class B             | N/A                 |
| Leakage Current            | N/A                 | 1.4 mA @ 240 V      | 1.75 mA @ 240 V    | 1.4 mA @ 240 V      | N/A                 |
| <b>Outputs:</b>            |                     |                     |                    |                     |                     |
| Output Main                | 12 V / 70 A         | 12 V / 85.5 A       | 12 V / 91.67 A     | 12 V / 98 A         | 12 V / 98 A         |
| Output Stand-By            | 3.3 Vsb / 6 A       | 3.3 Vsb / 6 A       | 12 V / 3 A         | 3.3 Vsb / 6 A       | 3.3 Vsb / 6 A       |
| OCP/OVP/OTP                | YES                 | YES                 | YES                | YES                 | YES                 |
| I <sup>2</sup> C Control   | YES                 | YES                 | YES                | YES                 | YES                 |
| <b>Environmental</b>       |                     |                     |                    |                     |                     |
| Operating Temp             | -10 °C to 50 °C     | -10 °C to 50 °C     | 10 °C to 50 °C     | -10 °C to 50 °C     | -10 °C to 50 °C     |
| Derating                   | 50% at 70 °C        | 50% at 70 °C        | N/A                | 50% at 70 °C        | 50% at 70 °C        |
| Storage                    | -40 °C to +85 °C    | -40 °C to +85 °C    | -40 °C to +70 °C   | -40 °C to +85 °C    | -40 °C to +85 °C    |
| RoHS Compliant             | YES                 | YES                 | YES                | YES                 | YES                 |
| MTBF                       | 500K Hours          | 500K Hours          | 200K Hours         | 500K Hours          | 500K Hours          |
| <b>Other</b>               |                     |                     |                    |                     |                     |
| Size (inch)                | 1.57 x 3.20 x 11.00 | 1.57 x 3.20 x 11.00 | 1.57 x 3.39 x 7.75 | 1.57 x 3.20 x 11.00 | 1.57 x 3.20 x 11.00 |
| Size (mm)                  | 40 x 81.3 x 279.4   | 40 x 81.3 x 279.4   | 42 x 86.3 x 196.5  | 40 x 81.3 x 279.4   | 40 x 81.3 x 279.4   |
| Power Density              | 15.38               | 18.95               | 26.73796791        | 21.71               | 21.71               |
| Cubic Inches               | 55.44               | 55.44               | 41.14              | 55.44               | 55.44               |
| Pro-E Files                | YES                 | YES                 | YES                | YES                 | YES                 |
| Thermal Data               | YES                 | YES                 | YES                | YES                 | YES                 |
| PQ Airflow Curves          | YES                 | YES                 | YES                | YES                 | YES                 |
| Warranty                   | Two Years           | Two Years           | Two Years          | Two Years           | Two Years           |
| <b>Ordering Codes</b>      |                     |                     |                    |                     |                     |
| Standard                   | DS850DC-3           | DS1050-3            | DS1100PED-3        | DS1200-3            | DS1200DC-3          |
| ALT Standby                | DS850DC-3-003       | DS1050-3-002        |                    | DS1200-3-002        | DS1200DC-3-002      |
| Reverse Air                | DS850DC-3-004       | DS1050-3-001        | DS1100PED-3-001    | DS1200-3-003        | DS1200DC-3-001      |
| ALT Standby & Reverse Air  | DS850DC-3-005       | DS1050-3-003        |                    | DS1200-3-004        | DS1200DC-3-003      |
| Fan Off with inhibit       |                     |                     |                    |                     |                     |
| Disable External Fan Drive |                     |                     |                    |                     |                     |





**NEW!**

**NEW!**

**NEW!**

|                            | DS1500-3             | DS1600SPE-3        | DS2000-3           | DS2500PE-3          | DS2900            | DS3000PE-3           |
|----------------------------|----------------------|--------------------|--------------------|---------------------|-------------------|----------------------|
| <b>Input:</b>              |                      |                    |                    |                     |                   |                      |
| Input Range                | 90-264 Vac           | 180-264 Vac        | 90-264 Vac         | 180-264Vac          | 180-264 Vac       | 208-264 Vac          |
| Frequency                  | 47-63 Hz             | 47-63 Hz           | 47-63 Hz           | 47-63 Hz            | 47-63 Hz          | 47-63 Hz             |
| Efficiency                 | 80% Typ              | 94% Typ            | 87% Typ            | 94% Typ             | 90% Typ           | 94% Typ              |
| EMI/RFI                    | Class B              | Class A            | Class B            | Class A             | Class B           | Class A              |
| Leakage Current            | 1.4 mA @ 240 V       | 1.75 mA @ 240 V    | 1.4 mA @ 240 V     | 0.75 mA @ 240 V     | 1.4 mA @ 240 V    | 0.58 mA @ 240 V      |
| <b>Outputs:</b>            |                      |                    |                    |                     |                   |                      |
| Output Main                | 12 V / 123 A         | 12 V / 133.3 A     | 12 V / 165 A       | 12 V / 208.3 A      | 12 V / 240 A      | 12 V / 250 A         |
| Output Stand-By            | 3.3 Vsb / 7 A        | 12 V / 4.5 A       | 3.3 Vsb / 9 A      | 3.3 V / 1 A         | 3.3 Vsb / 3 A     | 12 V / 4.5 A         |
| OCP/OVP/OTP                | YES                  | YES                | YES                | YES                 | YES               | YES                  |
| I <sup>2</sup> C Control   | NO                   | YES                | YES                | YES                 | YES               | YES                  |
| <b>Environmental</b>       |                      |                    |                    |                     |                   |                      |
| Operating Temp             | -10 °C to 50 °C      | 0 °C to 50 °C      | -10 °C to 50 °C    | 10 °C to 50 °C      | 0 °C to 50 °C     | 0 °C to 40 °C        |
| Derating                   | 50% at 70 °C         | 50% at 70 °C       | N/A                | N/A                 | N/A               | 25% at 50 °C         |
| Storage                    | -40 °C to +85 °C     | -40 °C to +85 °C   | -40 °C to +85 °C   | -40 °C to +60 °C    | -40 °C to +85 °C  | -40 °C to +85 °C     |
| RoHS Compliant             | YES                  | YES                | YES                | YES                 | YES               | YES                  |
| MTBF                       | 500K Hours           | 200K Hours         | 500K Hours         | 750K Hours          | 500K Hours        | 400K Hours           |
| <b>Other</b>               |                      |                    |                    |                     |                   |                      |
| Size (inch)                | 2.8 x 4.9 x 7.5      | 1.57 x 3.39 x 7.76 | 1.57 x 4.2 x 11.6  | 1.69 x 5.47 x 10.63 | 3.07 x 4.17 x 8.5 | 4.15 x 2.78 x 11.12  |
| Size (mm)                  | 71.1 x 124.5 x 190.5 | 43 x 86.3 x 196.5  | 40 x 106.7 x 295.7 | 42.9 x 139 x 270    | 78 x 106 x 217    | 105.5 x 70.6 x 282.6 |
| Power Density              | 12.63                | 38.89158969        | 26.2               | 25.44011397         | 26.7              | 26.26280312          |
| Cubic Inches               | 102.9                | 41.14              | 76.5               | 98.27               | 108.8             | 114.23               |
| Pro-E Files                | YES                  | YES                | YES                | YES                 | YES               | YES                  |
| Thermal Data               | YES                  | YES                | YES                | YES                 | YES               | YES                  |
| PQ Airflow Curves          | YES                  | YES                | YES                | YES                 | YES               | YES                  |
| Warranty                   | Two Years            | Two Years          | Two Years          | Two Years           | Two Years         | Two Years            |
| <b>Ordering Codes</b>      |                      |                    |                    |                     |                   |                      |
| Standard                   | DS1500-3             | DS1600SPE-3        | DS2000-3           | DS2500PE-3          | DS2900-3          | DS3000PE-3           |
| ALT Standby                |                      |                    | DS2000-3-002       |                     | DS2900-3-002      |                      |
| Reverse Air                | DS1500-3-001         | DS1600SPE-3-001    | DS2000-3-001       |                     | DS2900-3-001      |                      |
| ALT Standby & Reverse Air  |                      |                    |                    |                     | DS2900-3-003      |                      |
| Fan Off with inhibit       |                      |                    |                    |                     |                   |                      |
| Disable External Fan Drive |                      |                    |                    |                     |                   |                      |

# ADN-C Series Single Phase

120-960 Watts

## Special Features

- Slim form factor
- Five year warranty
- High efficiency > 90% typical
- Full power at 60 °C
- PowerBoost technology
- Industrial grade design
  - Metal mounting clip
  - Metal case
- MTBF > 450,000h demonstrated at 40 °C
- Active PFC > 0.92
- Adjustable output
- Overvoltage protection with auto recovery
- Continuous short-circuit and overload protection
- SEMI F47 Sag Immunity
- New visual diagnostic LED
- Three Status LEDs
  - Input, Output, Alarm
- DC OK Relay
- Parallel operation capability
- Screw terminal connections
- RoHS compliant
- No tools required for mounting



## Electrical Specifications

| Input          |   |
|----------------|---|
| AC Input range | Nominal: 115-230 Vac<br>85-264 Vac  |
| DC Input range | 90-375 Vdc  |
| Frequency      | 47-67 Hz, 400 Hz  |
| Efficiency     | > 90%   |
| Inrush current | ADN5-24-1PM-C: < 15 A<br>ADN10-24-1PM-C: < 30 A<br>ADN20-24-1PM-C: < 40 A |
| PFC            | Active, better than 0.92  |

| Output                     |   |
|----------------------------|---|
| Nominal voltage            | ADN5-24-1PM-C & ADN10-24-1PM-C: 24 Vdc (22.5-28.5 Vdc Adj)<br>ADN20-24-1PM-C: 24 Vdc (24-28 Vdc Adj)  |
| Initial voltage setting    | 24.5 V ±1%  |
| Hold-up time               | > 20 ms at full load (100 Vac Input @ Tamb = +25 °C)  |
| Voltage regulation         | < ±2% (combination line, load, time and temperature related changes)  |
| Ripple                     | ADN5-24-1PM-C & ADN10-24-1PM-C: < 50 mVpp<br>ADN20-24-1PM-C: < 100 mVpp   |
| Back EMF immunity          | < 35 Vdc  |
| PowerBoost                 | 1.5x nominal current for 4 seconds  |
| Short-circuit current      | 1.5x nominal current at near zero volts at short-circuit condition  |
| Parallel operation         | Switch selectable single unit or parallel unit operation. Units will not be damaged by parallel operation (regardless of switch position setting) |
| Output noise suppression   | Radiated EMI values below EN61000-6-2   |
| Overvoltage protection     | > 30.5 Vdc but < 33 Vdc, auto recovery  |
| Line and load regulation   | < 0.5%  |
| Time and temperature drift | < 1%  |



| Power        | Voltage                  | Current | Size L x W x H (mm)                            | Model Number   |
|--------------|--------------------------|---------|--|----------------|
| <b>120 W</b> | 85-264 Vac<br>90-375 Vdc | 5 A     | 4.85" x 1.97" x 4.37"<br>(123 x 50 x 111)      | ADN5-24-1PM-C  |
| <b>240 W</b> | 85-264 Vac<br>90-375 Vdc | 10 A    | 4.85" x 2.36" x 4.37"<br>(123 x 60 x 111)      | ADN10-24-1PM-C |
| <b>480 W</b> | 85-264 Vac<br>90-375 Vdc | 20 A    | 4.85" x 3.42" x 4.96"<br>(123 x 87 x 126)      | ADN20-24-1PM-C |
| <b>960 W</b> | 85-264 Vac<br>90-375 Vdc | 40 A    | 4.81" x 7.09" x 4.85"<br>(122.2 x 180 x 123.3) | ADN40-24-1PM-C |

# ADN-C Series 3-Phase

120-960 Watts

NEW!



## Special Features

- Slim form factor
- Five year warranty
- High efficiency > 93% typical
- Full power at 60 °C
- PowerBoost technology
- Industrial grade design – metal cases
- MTBF > 450,000h demonstrated at 40 °C
- Active PFC
- Adjustable output
- Overvoltage protection with auto recovery
- Continuous short-circuit and overload protection
- Three Status LEDs – Input, Output, Alarm
- DC OK Relay
- Parallel operation capability
- Screw terminal connections
- RoHS compliant
- No tools required for mounting

## Electrical Specifications

| Input                  |  |
|------------------------|--|
| Nominal voltage        | 380-480 Vac  |
| AC Input range         | 320-540 Vac  |
| DC Input range         | 450-720 Vdc for ADN20  |
| Frequency              | 50-60 Hz   |
| Efficiency             | 93% for ADN20; 94% for ADN40   |
| PFC                    | Active power factor correction   |
| Two phase input        | Derate to 75% and 50% for ADN20 and ADN40 respectively under loss of 1 phase. Units will shut down if thermal threshold is exceeded under this condition   |
| Output                 |  |
| Nominal voltage        | 24 V (24.0-28.0 Vdc Adj.)  |
| Hold-up time           | > 20 ms for ADN20; > 15 ms for ADN40   |
| Voltage regulation     | < ±2% overall  |
| Ripple                 | < 100 mVpp   |
| PowerBoost             | 1.5x nominal current for 4 seconds   |
| Peak current           | 1.5x nominal current for 4 seconds minimum while holding voltage > 20 Vdc  |
| Parallel operation     | Single or parallel operation selectable via front switch. For redundant operation use of external diode module is preferred; ADN40 uses active paralleling |
| Power back immunity    | > 35 V   |
| Overvoltage protection | > 30.5 Vdc but < 33 Vdc, auto recovery   |



| Power        | Voltage                    | Current       | Size L x W x H (mm)                        | Model Number   |
|--------------|----------------------------|---------------|--|----------------|
| <b>120 W</b> | 320-540 Vac<br>450-760 Vdc | 5 A @ 24 Vdc  | 4.85" x 1.97" x 4.37"<br>(123 x 50 x 111)  | ADN5-24-3PM-C  |
| <b>240 W</b> | 320-540 Vac<br>450-760 Vdc | 10 A @ 24 Vdc | 4.85" x 2.36" x 4.37"<br>(123 x 60 x 111)  | ADN10-24-3PM-C |
| <b>480 W</b> | 320-540 Vac<br>450-760 Vdc | 20 A @ 24 Vdc | 4.68" x 3.34" x 4.85"<br>(119 x 85 x 123)  | ADN20-24-3PM-C |
| <b>960 W</b> | 320-540 Vac                | 40 A @ 24 Vdc | 4.85" x 7.09" x 4.85"<br>(123 x 180 x 123) | ADN40-24-3PM-C |



## DC-DC Converters

*Emerson Network Power is widely acknowledged as an industry leader in distributed power applications and produces an exceptionally wide range of DC-DC conversion products.*



# Distributed Power Architecture

Emerson Network Power understands the needs and nuances of developing power systems using Distributed Power Architecture. We know it is your job to create the most efficient, cost-effective, quality system, and deliver it in a timely fashion.

From full-system power to board-level components, high-power isolated front ends to a full line of isolated and non-isolated DC-DC modules, Emerson Network Power is the source for today's power systems.

## Distributed Power Architecture DC-DC Conversion

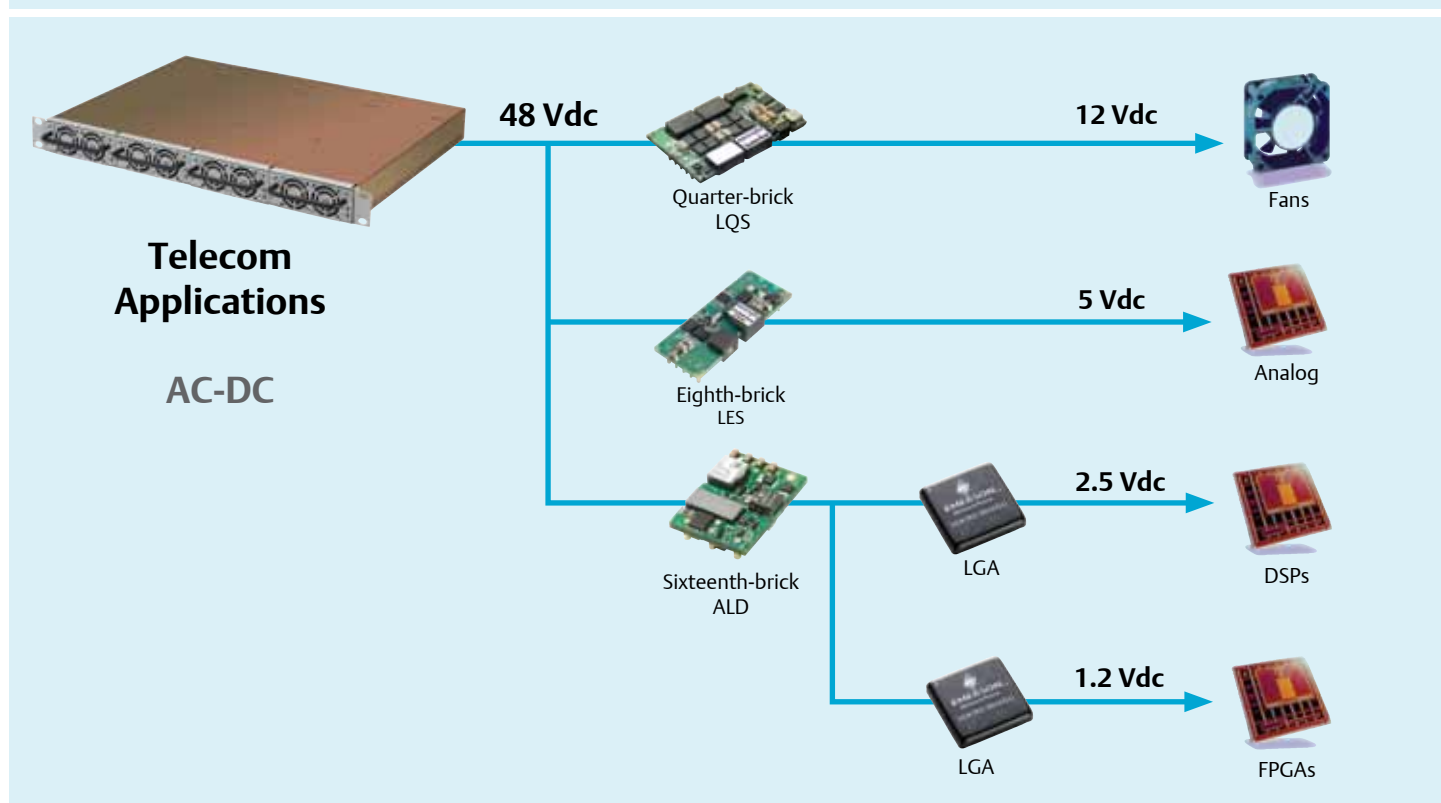
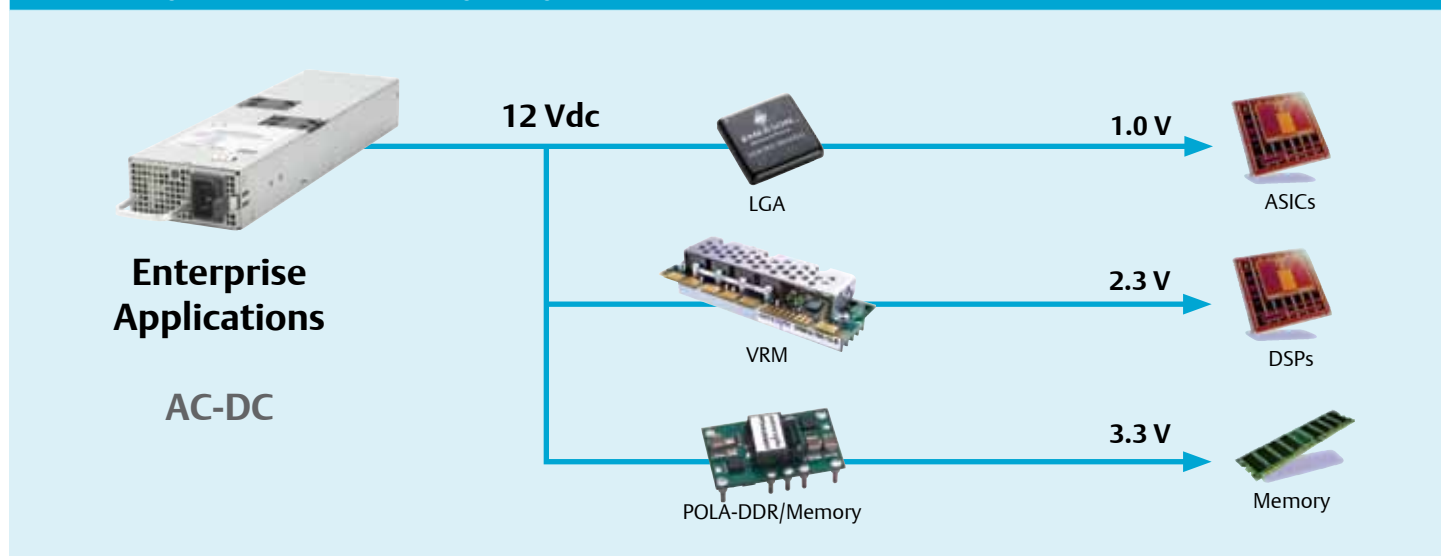

# Sixteenth-Brick



AVD75



ALD25Y48

## Special Features

- Industry leading sixteenth-brick standard package and feature sets
- Scalable offering: 35 W, 50 W, 75 W and 85 W platforms
- Mechanical options for optimum mounting flexibility: Through-hole (default) or surface mount (suffix “-S”) termination; 5 mm (default) or 3.7 mm through-hole pin length option
- Meets basic insulation
- Power densities as high as 146.5 W per cubic inch
- International safety standards approvals – UL, CSA, TÜV

| Vout         | Iout              | Input Voltage  | Package L x W x H (mm)                  | Efficiency | Model Number     |
|--------------|-------------------|----------------|---|------------|------------------|
| <b>1.2 V</b> | <b>Open-frame</b> |                |   |            |                  |
|              | 15 A              | 48 V (36-75 V) | 1.3" x 0.9" x 0.35" (33 x 22.86 x 8.89) | 84%        | ALD15K48N-L      |
|              | 25 A              | 48 V (36-75 V) | 1.3" x 0.9" x 0.34" (33 x 22.9 x 8.9)   | 84%        | AVD75-48S1V2-6L  |
|              | <b>Baseplate</b>  |                |   |            |                  |
|              | 25 A              | 48 V (36-75 V) | 1.3" x 0.9" x 0.5" (33 x 22.9 x 12.7)   | 84%        | AVD75-48S1V2B-6L |
| <b>1.5 V</b> | <b>Open-frame</b> |                |   |            |                  |
|              | 15 A              | 48 V (36-75 V) | 1.3" x 0.9" x 0.35" (33 x 22.86 x 8.89) | 85%        | ALD15M48N-L      |
|              | 25 A              | 48 V (36-75 V) | 1.3" x 0.9" x 0.35" (33 x 22.86 x 8.89) | 85%        | ALD25M48N-L      |
| <b>1.8 V</b> | <b>Open-frame</b> |                |   |            |                  |
|              | 13 A              | 48 V (36-75 V) | 1.3" x 0.9" x 0.35" (33 x 22.86 x 8.89) | 87%        | ALD13Y48N-L      |
|              | 25 A              | 48 V (36-75 V) | 1.3" x 0.9" x 0.35" (33 x 22.86 x 8.89) | 88%        | ALD25Y48N-L      |
| <b>2.5 V</b> | <b>Open-frame</b> |                |   |            |                  |
|              | 11 A              | 48 V (36-75 V) | 1.3" x 0.9" x 0.35" (33 x 22.86 x 8.89) | 89%        | ALD11G48N-L      |
|              | 20 A              | 48 V (36-75 V) | 1.3" x 0.9" x 0.35" (33 x 22.86 x 8.89) | 89%        | ALD20G48N-L      |
| <b>3.3 V</b> | <b>Open-frame</b> |                |   |            |                  |
|              | 15 A              | 48 V (36-75 V) | 1.3" x 0.9" x 0.37" (33 x 22.9 x 9.5)   | 91%        | AVD50B-48S3V3-6L |
|              | 20 A              | 48 V (36-75 V) | 1.3" x 0.9" x 4.1" (33 x 22.9 x 10.5)   | 92%        | AVD75-48S3V3-6L  |
|              | 25 A              | 48 V (36-75 V) | 1.3" x 0.9" x 4.1" (33 x 22.9 x 10.5)   | 92%        | AVD85-48S3V3-6L  |
|              | <b>Baseplate</b>  |                |   |            |                  |
|              | 20 A              | 48 V (36-75 V) | 1.3" x 0.9" x 0.5" (33 x 22.9 x 12.7)   | 92%        | AVD75-48S3V3B-6L |
|              | 25 A              | 48 V (36-75 V) | 1.3" x 0.9" x 0.5" (33 x 22.9 x 12.7)   | 92%        | AVD85-48S3V3B-6L |
| <b>5 V</b>   | <b>Open-frame</b> |                |   |            |                  |
|              | 7 A               | 48 V (36-75 V) | 1.3" x 0.9" x 0.35" (33 x 22.86 x 8.89) | 91%        | ALD07A48N-L      |
|              | 10 A              | 48 V (36-75 V) | 1.3" x 0.9" x 0.37" (33 x 22.9 x 9.5)   | 92%        | AVD50-48S05-6L   |
|              | 12 A              | 48 V (36-75 V) | 1.3" x 0.9" x 0.35" (33 x 22.86 x 8.89) | 91%        | ALD12A48N-L      |
| <b>12 V</b>  | <b>Open-frame</b> |                |   |            |                  |
|              | 2.75 A            | 48 V (36-75 V) | 1.3" x 0.9" x 0.35" (33 x 22.86 x 8.89) | 92%        | ALD03B48N-L      |
|              | 7 A               | 48 V (36-75 V) | 1.3" x 0.9" x 0.34" (33 x 22.9 x 8.9)   | 92%        | AVD85-48S12-6L   |
|              | <b>Baseplate</b>  |                |   |            |                  |
|              | 7 A               | 48 V (36-75 V) | 1.3" x 0.9" x 0.5" (33 x 22.9 x 12.7)   | 92%        | AVD85-48S12B-6L  |

# Eighth-Brick

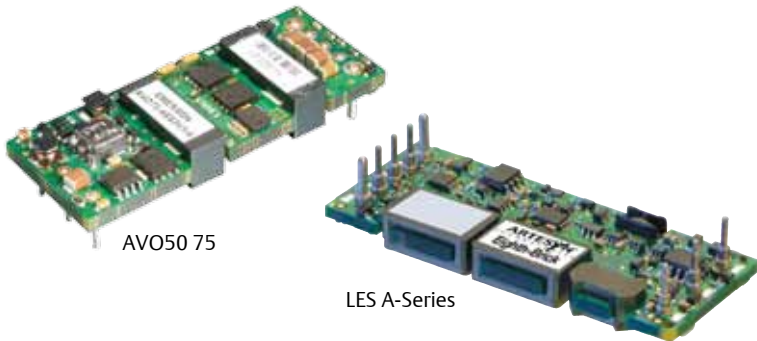

## Special Features

- Industry leading eighth-brick standard package and feature sets
- Scalable output power offering: Low power 80 W series or up to 240 W high power series
- Mechanical options for optimum mounting flexibility: Open-frame (ALO, LES, AVO) or baseplate (AEO or AVO-B) construction; Through-hole (default) or surface mount (suffix “-S”) termination; 5 mm (default) or 3.7 mm through-hole pin length option
- Meets basic insulation
- Power densities as high as 181 W per cubic inch
- Wide operating temperature range
- International safety standards approvals – UL, CSA, TÜV

| Vout         | Iout              | Input Voltage                           | Package L x W x H (mm)                     | Efficiency         | Model Number       |
|--------------|-------------------|---|--|--------------------|--------------------|
| <b>1.0 V</b> | <b>Open-frame</b> |   |  |                    |                    |
|              | 25 A              | 48 V (36-75 V)                          | 2.3" x 0.9" x 0.36" (58.42 x 22.86 x 9.14) | 85%                | LES25B48-1V0REJ    |
| <b>1.2 V</b> | <b>Open-frame</b> |   |  |                    |                    |
|              | 20 A              | 48 V (36-75 V)                          | 2.3" x 0.9" x 0.34" (57.9 x 22.9 x 8.5)    | 86%                | AVO50-48S1V2-4     |
|              | 25 A              | 48 V (36-75 V)                          | 2.3" x 0.9" x 0.34" (57.9 x 22.9 x 8.5)    | 86%                | AVO75-48S1V2-4     |
|              | 50 A              | 48 V (36-75 V)                          | 2.3" x 0.9" x 0.34" (58.42 x 22.86 x 8.64) | 86%                | LES50A48-1V2REJ    |
|              | <b>Baseplate</b>  |   |  |                    |                    |
| 50 A         | 48 V (36-75 V)    | 2.3" x 0.9" x 0.5" (57.9 x 22.9 x 12.7) | 85.5%                                      | AVO100-48S1V2B-6L  |                    |
| <b>1.5 V</b> | <b>Open-frame</b> |   |  |                    |                    |
|              | 20 A              | 48 V (36-75 V)                          | 2.3" x 0.9" x 0.34" (57.9 x 22.9 x 8.5)    | 88%                | AVO50-48S1V5-4     |
|              | 40 A              | 48 V (36-75 V)                          | 2.3" x 0.9" x 0.34" (57.9 x 22.9 x 8.5)    | 89%                | AVO100B-48S1V5-6L  |
|              | <b>Baseplate</b>  |   |  |                    |                    |
| 40 A         | 48 V (36-75 V)    | 2.3" x 0.9" x 0.5" (57.9 x 22.9 x 12.7) | 89%  | AVO100B-48S1V5B-6L |                    |
| <b>1.8 V</b> | <b>Open-frame</b> |   |  |                    |                    |
|              | 20 A              | 48 V (36-75 V)                          | 2.3" x 0.9" x 0.34" (57.9 x 22.9 x 8.5)    | 89%                | AVO50-48S1V8-4     |
|              | 20 A              | 24 V (18-36 V)                          | 2.3" x 0.9" x 0.34" (58.42 x 22.86 x 8.64) | 91%                | LES20A24-1V8REJ    |
|              | 25 A              | 48 V (36-75 V)                          | 2.3" x 0.9" x 0.34" (57.9 x 22.9 x 8.5)    | 89%                | AVO75-48S1V8-4     |
|              | 40 A              | 48 V (36-75 V)                          | 2.3" x 0.9" x 0.34" (57.9 x 22.9 x 8.5)    | 89.5%              | AVO100-48S1V8-6L   |
|              | <b>Baseplate</b>  |   |  |                    |                    |
| 40 A         | 48 V (36-75 V)    | 2.3" x 0.9" x 0.5" (57.9 x 22.9 x 12.7) | 89.5%                                      | AVO100-48S1V8B-6L  |                    |
| <b>2.5 V</b> | <b>Open-frame</b> |   |  |                    |                    |
|              | 20 A              | 48 V (36-75 V)                          | 2.3" x 0.9" x 0.34" (57.9 x 22.9 x 8.5)    | 90%                | AVO50-48S2V5-4     |
|              | 25 A              | 48 V (36-75 V)                          | 2.3" x 0.9" x 0.34" (57.9 x 22.9 x 8.5)    | 90%                | AVO75-48S2V5-4     |
|              | 35 A              | 48 V (36-75 V)                          | 2.3" x 0.9" x 0.34" (57.9 x 22.9 x 8.5)    | 91.5%              | AVO100-48S2V5-6L   |
|              | 40 A              | 48 V (36-75 V)                          | 2.3" x 0.9" x 0.34" (58.42 x 22.86 x 8.64) | 91%                | LES40A48-2V5REJ    |
|              | <b>Baseplate</b>  |   |  |                    |                    |
| 35 A         | 48 V (36-75 V)    | 2.3" x 0.9" x 0.5" (57.9 x 22.9 x 12.7) | 91.5%                                      | AVO100-48S2V5B-6L  |                    |
| <b>3.3 V</b> | <b>Open-frame</b> |   |  |                    |                    |
|              | 15 A              | 48 V (36-75 V)                          | 2.3" x 0.9" x 0.34" (57.9 x 22.9 x 8.5)    | 90%                | AVO50C-48S3V3-6    |
|              | 20 A              | 24 V (18-36 V)                          | 2.3" x 0.9" x 0.34" (58.42 x 22.86 x 8.64) | 90%                | LES20A24-3V3REJ    |
|              | 20 A              | 24V/48 V (19-60 V)                      | 2.3" x 0.9" x 0.32" (58.42 x 22.86 x 8.13) | 91%                | ALO20F36N-L        |
|              | 20 A              | 48 V (36-75 V)                          | 2.3" x 0.9" x 0.34" (57.9 x 22.9 x 8.5)    | 91%                | AVO75-48S3V3-4     |
|              | 30 A              | 48 V (36-75 V)                          | 2.3" x 0.9" x 0.34" (57.9 x 22.9 x 8.5)    | 91%                | AVO100B-48S3V3-6L  |
|              | <b>Baseplate</b>  |   |  |                    |                    |
|              | 30 A              | 48 V (36-75 V)                          | 2.3" x 0.9" x 0.4" (58.42 x 22.86 x 10.16) | 91%                | AVO100C-48S3V3B-4L |

| V <sub>out</sub> | I <sub>out</sub>  | Input Voltage  | Package L x W x H (mm)                     | Efficiency                                 | Model Number     |
|------------------|-------------------|----------------|--|--|------------------|
| <b>5 V</b>       | <b>Open-frame</b> |                |  |  |                  |
|                  | <b>10 A</b>       | 48 V (36-75 V) | 2.3" x 0.9" x 0.34" (57.9 x 22.9 x 8.5)    | 91%  | AVO50-48S05-4    |
|                  | <b>13 A</b>       | 48 V (36-75 V) | 2.3" x 0.9" x 0.36" (58.42 x 22.86 x 9.14) | 92%  | LES13B48-5V0REJ  |
|                  | <b>15 A</b>       | 48 V (36-75 V) | 2.3" x 0.9" x 0.34" (57.9 x 22.9 x 8.5)    | 91%  | AVO75-48S05-6    |
|                  | <b>20 A</b>       | 48 V (36-75 V) | 2.3" x 0.9" x 0.34" (57.9 x 22.9 x 8.5)    | 92.8%                                      | AVO100-48S05-6L  |
|                  | <b>Baseplate</b>  |                |  |  |                  |
|                  | <b>20 A</b>       | 48 V (36-75 V) | 2.3" x 0.9" x 0.5" (57.9 x 22.9 x 12.7)    | 92.8%                                      | AVO100-48S05B-6L |
| <b>12 V</b>      | <b>Open-frame</b> |                |  |  |                  |
|                  | <b>4.2 A</b>      | 48 V (36-75 V) | 2.3" x 0.9" x 0.34" (57.9 x 22.9 x 8.5)    | 91%  | AVO50-48S12-6L   |
|                  | <b>6.3 A</b>      | 48 V (36-75 V) | 2.3" x 0.9" x 0.34" (57.9 x 22.9 x 8.5)    | 91%  | AVO75-48S12P-4   |
|                  | <b>10 A</b>       | 48 V (36-75 V) | 2.3" x 0.9" x 0.32" (58.42 x 22.86 x 8.13) | 92%  | ALO10B48N-L      |
|                  | <b>20 A</b>       | 48 V (41-75 V) | 2.3" x 0.9" x 0.37" (57.9 x 22.9 x 9.5)    | 94%  | AVO240-48S12-6L  |
|                  | <b>Baseplate</b>  |                |  |  |                  |
|                  |                   | <b>4 A</b>     | 48 V (36-75 V)                             | 2.3" x 0.9" x 0.4" (58.42 x 22.86 x 10.16) | 93%              |
|                  | <b>10 A</b>       | 48 V (36-75 V) | 2.3" x 0.9" x 0.4" (58.42 x 22.86 x 10.16) | 92%  | AEO10B48N-L      |
|                  | <b>20 A</b>       | 48 V (41-75 V) | 2.3" x 0.9" x 0.5" (57.9 x 22.9 x 12.7)    | 94%  | AVO240-48S12B-6L |





# Quarter-Brick



## Special Features

- Industry leading quarter-brick standard package and feature sets
- Up to 100 A offering
- Wide operating temperature range
- Meets basic insulation
- Exceptional dynamic response and reactive loading capability
- Monotonic start-up characteristic
- International safety standards approvals – UL, CSA, TÜV

| V <sub>out</sub> | I <sub>out</sub>  | Input Voltage     | Package L x W x H (mm)                      | Efficiency                                | Model Number       |                 |
|------------------|-------------------|-------------------|---|---|--------------------|-----------------|
| 1.2 V            | <b>Open-frame</b> |                   |   |   |                    |                 |
|                  | 25 A              | 48 V (36-75 V)    | 2.28" x 1.45" x 0.38" (57.9 x 36.8 x 9.6)   | 86%                                       | AGQ100-48S1V2-4    |                 |
|                  | 40 A              | 48 V (36-75 V)    | 2.28" x 1.45" x 0.39" (57.9 x 36.8 x 9.8)   | 85%                                       | AGQ200-48S1V2-4L   |                 |
|                  | 60 A              | 48 V (36-75 V)    | 2.28" x 1.45" x 0.39" (57.9 x 36.8 x 9.8)   | 85%                                       | AGQ300-48S1V2-4L   |                 |
|                  | 100 A             | 48 V (36-75 V)    | 2.3" x 1.45" x 0.34" (58.42 x 36.83 x 8.64) | 86%                                       | LQS100A48-1V2REJ   |                 |
|                  | <b>Baseplate</b>  |                   |   |   |                    |                 |
|                  | 25 A              | 48 V (36-75 V)    | 2.28" x 1.45" x 0.50" (57.9 x 36.8 x 12.7)  | 86%                                       | AGQ100-48S1V2B-4   |                 |
|                  | 40 A              | 48 V (36-75 V)    | 2.28" x 1.45" x 0.50" (57.9 x 36.8 x 12.7)  | 85%                                       | AGQ200-48S1V2B-4L  |                 |
|                  | 60 A              | 48 V (36-75 V)    | 2.28" x 1.45" x 0.50" (57.9 x 36.8 x 12.7)  | 85%                                       | AGQ300-48S1V2B-4L  |                 |
|                  | 1.5 V             | <b>Open-frame</b> |   |   |                    |                 |
| 25 A             |                   | 48 V (36-75 V)    | 2.28" x 1.45" x 0.38" (57.9 x 36.8 x 9.6)   | 87%                                       | AGQ100-48S1V5-4    |                 |
| 40 A             |                   | 48 V (36-75 V)    | 2.28" x 1.45" x 0.50" (57.9 x 36.8 x 12.7)  | 86%                                       | AGQ200-48S1V5-4L   |                 |
| 80 A             |                   | 48 V (36-75 V)    | 2.3" x 1.45" x 0.34" (58.42 x 36.83 x 8.64) | 89%                                       | LQS80A48-1V5REJ    |                 |
| 100 A            |                   | 48 V (36-75 V)    | 2.3" x 1.45" x 0.34" (58.42 x 36.83 x 8.64) | 89%                                       | LQS100A48-1V5REJ   |                 |
| <b>Baseplate</b> |                   |                   |   |   |                    |                 |
| 25 A             |                   | 48 V (36-75 V)    | 2.28" x 1.45" x 0.50" (57.9 x 36.8 x 12.7)  | 87%                                       | AGQ100-48S1V5B-4   |                 |
| 40 A             |                   | 48 V (36-75 V)    | 2.28" x 1.45" x 0.50" (57.9 x 36.8 x 12.7)  | 86%                                       | AGQ200-48S1V5B-4L  |                 |
| 1.8 V            |                   | <b>Open-frame</b> |   |   |                    |                 |
|                  |                   | 25 A              | 48 V (36-75 V)                              | 2.28" x 1.45" x 0.38" (57.9 x 36.8 x 9.6) | 87%                | AGQ100-48S1V8-4 |
|                  | 40 A              | 48 V (36-75 V)    | 2.28" x 1.45" x 0.39" (57.9 x 36.8 x 9.8)   | 88%                                       | AGQ200-48S1V8-4L   |                 |
|                  | 50 A              | 48 V (36-75 V)    | 2.3" x 1.45" x 0.34" (57.42 x 36.83 x 8.64) | 90%                                       | LQS50A48-1V8REJ    |                 |
|                  | 80 A              | 48 V (36-75 V)    | 2.3" x 1.45" x 0.34" (57.42 x 36.83 x 8.64) | 90%                                       | LQS80A48-1V8REJ    |                 |
|                  | 100 A             | 48 V (36-75 V)    | 2.3" x 1.45" x 0.34" (57.42 x 36.83 x 8.64) | 90%                                       | LQS100A48-1V8REJ   |                 |
|                  | <b>Baseplate</b>  |                   |   |   |                    |                 |
|                  | 25 A              | 48 V (36-75 V)    | 2.28" x 1.45" x 0.50" (57.9 x 36.8 x 12.7)  | 87%                                       | AGQ100-48S1V8B-4   |                 |
|                  | 40 A              | 48 V (36-75 V)    | 2.28" x 1.45" x 0.50" (57.9 x 36.8 x 12.7)  | 88%                                       | AGQ200-48S1V8B-4L  |                 |
|                  | 2.5 V             | <b>Open-frame</b> |   |   |                    |                 |
| 25 A             |                   | 48 V (36-75 V)    | 2.28" x 1.45" x 0.39" (57.9 x 36.8 x 9.8)   | 88%                                       | AGQ100-48S2V5-4    |                 |
| 40 A             |                   | 48 V (36-75 V)    | 2.28" x 1.45" x 0.39" (57.9 x 36.8 x 9.8)   | 90%                                       | AGQ200B-48S2V5-4L  |                 |
| 50 A             |                   | 48 V (36-75 V)    | 2.3" x 1.45" x 0.34" (58.42 x 36.83 x 8.64) | 90%                                       | LQS50A48-2V5REJ    |                 |
| 80 A             |                   | 48 V (36-75 V)    | 2.3" x 1.45" x 0.34" (58.42 x 36.83 x 8.64) | 91%                                       | LQS80A48-2V5REJ    |                 |
| <b>Baseplate</b> |                   |                   |   |   |                    |                 |
| 25 A             |                   | 48 V (36-75 V)    | 2.28" x 1.45" x 0.50" (57.9 x 36.8 x 12.7)  | 88%                                       | AGQ100-48S2V5B-4   |                 |
| 40 A             |                   | 48 V (36-75 V)    | 2.28" x 1.45" x 0.50" (57.9 x 36.8 x 12.7)  | 90%                                       | AGQ200B-48S2V5B-4L |                 |

| Vout         | Iout              | Input Voltage                               | Package L x W x H (mm)                       | Efficiency         | Model Number       |
|--------------|-------------------|---|--|--------------------|--------------------|
| <b>3.3 V</b> | <b>Open-frame</b> |   |  |                    |                    |
|              | 25 A              | 48 V (36-75 V)                              | 2.28" x 1.45" x 0.38" (57.9 x 36.8 x 9.6)    | 91%                | AGQ100C-48S3V3-6L  |
|              | 30 A              | 24 V (18-36 V)                              | 2.3" x 1.45" x 0.34" (58.42 x 36.83 x 8.64)  | 90%                | LQS30A24-3V3REJ    |
|              | 40 A              | 48 V (36-75 V)                              | 2.28" x 1.45" x 0.39" (57.9 x 36.8 x 9.8)    | 91%                | AGQ200B-48S3V3-4L  |
|              | 50 A              | 48 V (36-75 V)                              | 2.3" x 1.45" x 0.34" (58.42 x 36.83 x 8.64)  | 91%                | LQS50A48-3V3REJ    |
|              | 60 A              | 48 V (36-75 V)                              | 2.3" x 1.45" x 0.34" (58.42 x 36.83 x 8.64)  | 91%                | LQS60A48-3V3REJ    |
|              | <b>Baseplate</b>  |   |  |                    |                    |
|              | 25 A              | 48 V (36-75 V)                              | 2.28" x 1.45" x 0.50" (57.9 x 36.8 x 12.7)   | 91%                | AGQ100C-48S3V3B-6L |
| 40 A         | 48 V (36-75 V)    | 2.28" x 1.45" x 0.50" (57.9 x 36.8 x 12.7)  | 91%  | AGQ200B-48S3V3B-4L |                    |
| <b>5 V</b>   | <b>Open-frame</b> |   |  |                    |                    |
|              | 30 A              | 24 V (18-36 V)                              | 2.28" x 1.45" x 0.39" (57.9 x 36.8 x 9.8)    | 91%                | AGQ150-48S05-4L    |
|              | 40 A              | 48 V (36-75 V)                              | 2.3" x 1.45" x 0.34" (58.42 x 36.83 x 8.64)  | 92%                | LQS40A48-5V0REJ    |
|              | <b>Baseplate</b>  |   |  |                    |                    |
|              | 30 A              | 48 V (36-75 V)                              | 2.28" x 1.45" x 0.50" (57.9 x 36.8 x 12.7)   | 91%                | AGQ150-48S05B-4L   |
| <b>12 V</b>  | <b>Open-frame</b> |   |  |                    |                    |
|              | 8.33 A            | 48 V (36-75 V)                              | 2.28" x 1.45" x 0.50" (57.9 x 36.8 x 12.7)   | 90%                | AGQ100-48S12-6L    |
|              | 20 A              | 48 V (36-75 V)                              | 2.3" x 1.45" x 0.36" (58.42 x 36.83 x 9.14)  | 93%                | ALQ20B48N-L        |
|              | <b>Baseplate</b>  |   |  |                    |                    |
|              | 8.33 A            | 48 V (36-75 V)                              | 2.28" x 1.45" x 0.50" (57.9 x 36.8 x 12.7)   | 90%                | AGQ100-48S12B-6L   |
|              | 20 A              | 48 V (36-75 V)                              | 2.3" x 1.45" x 0.42" (58.42 x 36.83 x 10.67) | 93%                | AEQ20B48N-L        |
| 33 A         | 48 V (36-75 V)    | 2.28" x 1.45" x 0.50" (57.9 x 36.83 x 12.7) | 93%  | AVQ400-48S12B-6L   |                    |



# Half-Brick



AGH100 150



AVE300

## Special Features

- Industry standard half-brick available up to 60A
- Open-frame and baseplate construction
- Highest efficiencies available
- Optimum transient load performance and reactive loading capacity
- Wide operating temperature range
- International safety standards approvals – UL, CSA, TÜV

| Vout         | Iout                      | Input Voltage  | Package L x W x H (mm)                       | Efficiency | Model Number      |
|--------------|---------------------------|----------------|--|------------|-------------------|
| <b>1.2 V</b> | <b>Open-frame</b>         |                |  |            |                   |
|              | 60 A                      | 48 V (36-75 V) | 2.4" x 2.3" x 0.4" (61 x 57.9 x 9.5)         | 86%        | AVE300-48S1V2-4   |
|              | <b>Baseplate</b>          |                |  |            |                   |
|              | 60 A                      | 48 V (36-75 V) | 2.4" x 2.3" x 0.5" (61 x 57.9 x 12.7)        | 86%        | AVE300-48S1V2B-4  |
| <b>1.5 V</b> | <b>Baseplate</b>          |                |  |            |                   |
|              | 60 A                      | 48 V (36-75 V) | 2.4" x 2.3" x 0.5" (61 x 57.9 x 12.7)        | 87%        | AVE300-48S1V5B-4  |
| <b>1.8 V</b> | <b>Baseplate</b>          |                |  |            |                   |
|              | 60 A                      | 48 V (36-75 V) | 2.4" x 2.3" x 0.5" (61 x 57.9 x 12.7)        | 89%        | AVE300-48S1V8B-4  |
| <b>2.5 V</b> | <b>Aluminum Substrate</b> |                |  |            |                   |
|              | 20 A                      | 48 V (36-75 V) | 2.4" x 2.3" x 0.5" (61 x 57.9 x 12.7)        | 86%        | AVE100-48S2V5     |
|              | <b>Open-frame</b>         |                |  |            |                   |
|              | 60 A                      | 48 V (36-75 V) | 2.4" x 2.3" x 0.4" (61 x 57.9 x 9.5)         | 91%        | AVE300-48S2V5-4   |
|              | <b>Baseplate</b>          |                |  |            |                   |
|              | 60 A                      | 48 V (36-75 V) | 2.4" x 2.3" x 0.5" (61 x 57.9 x 12.7)        | 91%        | AVE300-48S2V5B-4  |
| <b>3.3 V</b> | <b>Open-frame</b>         |                |  |            |                   |
|              | 8 A                       | 48 V (36-75 V) | 2.4" x 2.28" x 0.43" (60.96 x 57.91 x 10.92) | 90%        | EXB30-48S3V3J     |
|              | 25 A                      | 48 V (36-75 V) | 2.4" x 2.3" x 0.4" (61 x 57.9 x 9.5)         | 91%        | AGH100-48S3V3-4L  |
|              | 30 A                      | 48 V (36-75 V) | 2.4" x 2.28" x 0.39" (60.96 x 57.91 x 9.91)  | 91%        | EXB100-48S3V3-RJ  |
|              | <b>Aluminum Substrate</b> |                |  |            |                   |
|              | 40 A                      | 48 V (36-75 V) | 2.4" x 2.3" x 0.5" (61 x 57.9 x 12.7)        | 89%        | AVE200-48S3V3-4   |
|              | <b>Baseplate</b>          |                |  |            |                   |
|              | 25 A                      | 48 V (36-75 V) | 2.4" x 2.3" x 0.5" (61 x 57.9 x 12.7)        | 91%        | AGH100-48S3V3B-4L |
|              | 60 A                      | 48 V (36-75 V) | 2.4" x 2.3" x 0.5" (61 x 57.9 x 12.7)        | 92%        | AVE300-48S3V3B-4  |
| <b>5 V</b>   | <b>Open-frame</b>         |                |  |            |                   |
|              | 30 A                      | 48 V (36-75 V) | 2.4" x 2.3" x 0.4" (61 x 57.9 x 9.5)         | 91%        | AGH150-48S05-6    |
|              | <b>Baseplate</b>          |                |  |            |                   |
|              | 30 A                      | 48 V (36-75 V) | 2.4" x 2.3" x 0.5" (61 x 57.9 x 12.7)        | 91%        | AGH150-48S05B-6   |
| <b>12 V</b>  | <b>Open-frame</b>         |                |  |            |                   |
|              | 20A                       | 48 V (36-75 V) | 2.4" x 2.3" x 0.4" (61 x 57.9 x 9.5)         | 92%        | AVE240C-48S12-4L  |
|              | 30A                       | 48 V (36-75 V) | 2.4" x 2.3" x 0.4" (61 x 57.9 x 9.5)         | 94%        | AGH360-48S12-6L   |
|              | <b>Baseplate</b>          |                |  |            |                   |
|              | 8.33 A                    | 24 V (18-36 V) | 2.4" x 2.28" x 0.5" (60.96 x 57.91 x 12.7)   | 85%        | BXB100-24S12FLTJ  |
|              | 30 A                      | 48 V (36-75 V) | 2.4" x 2.3" x 0.5" (61 x 57.9 x 12.7)        | 94%        | AGH360-48S12B-6L  |
|              | 50 A                      | 48 V (36-75 V) | 2.4" x 2.3" x 0.5" (61 x 57.9 x 12.7)        | 95.5%      | AVE600-48S12B-4L  |

# Half-Brick Dual



EXB30

|                | Current           | Input Voltage  | Package L x W x H (mm)                      | Efficiency | Model Number       |
|----------------|-------------------|----------------|---|------------|--------------------|
| <b>3.3/5 V</b> | <b>Open-frame</b> |                |   |            |                    |
|                | <b>6/6 A</b>      | 24 V (18-36 V) | 2.4" x 2.28" x 0.5" (60.96 x 57.91 x 12.7)  | 87%        | EXB30-24D05-3V3J   |
|                | <b>6/6 A</b>      | 48 V (36-75 V) | 2.4" x 2.28" x 0.5" (60.96 x 57.91 x 12.)   | 88%        | EXB30-48D05-3V3J   |
|                | <b>7.5/7.5 A</b>  | 48 V (36-75 V) | 2.4" x 2.28" x 0.39" (60.96 x 57.91 x 9.91) | 89%        | EXB50-48D05-3V3-RJ |

# RF Power Bricks



AGF600



RFB300

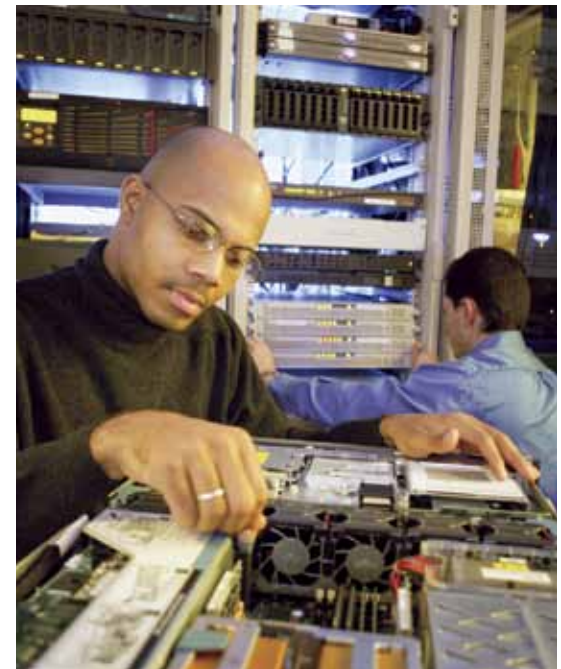

## Special Features

- Specialized high power bricks for RF applications such as base station power amplifiers
- Offered in 24 V and 48 V input voltages
- Wide output voltage adjustability
- -40 °C to 100 °C baseplate temperature for RFB, RFF and -40 °C to 85 °C for AVE, AGF baseplate temperature with no derating at rated power
- International safety standard approvals – UL, CSA, VDE, CB Report

## Half-Brick

| Vout              | Iout                  | Input Voltage  | Package L x W x H (mm)                     | Efficiency | Model Number       |
|-------------------|-----------------------|----------------|--|------------|--------------------|
| <b>7.2-13.2 V</b> | <b>Baseplate</b>      |                |  |            |                    |
|                   | <b>25 A</b>           | 24 V (18-36 V) | 2.4" x 2.27" x 0.5" (60.96 x 57.66 x 12.7) | 86%        | RFB300-24S12-R5Y   |
|                   | <b>29.2 A</b>         | 48 V (36-75 V) | 2.4" x 2.27" x 0.5" (60.96 x 57.66 x 12.7) | 86%        | RFB350-48S12-R5J   |
| <b>28 V</b>       | <b>Aluminum Board</b> |                |  |            |                    |
|                   | <b>12.5 A</b>         | 24 V (18-36 V) | 2.4" x 2.3" x 0.5" (61 x 57.9 x 12.7)      | 93%        | AVE350-24S28-6L    |
|                   | <b>12.5 A</b>         | 48 V (36-75 V) | 2.4" x 2.3" x 0.5" (61 x 57.9 x 12.7)      | 93%        | AVE350B-48S28-6    |
|                   | <b>16 A</b>           | 48 V (36-75 V) | 2.4" x 2.3" x 0.5" (61 x 57.9 x 12.7)      | 94%        | AVE450B-48S28-6L/M |

## Full-Brick

| Vout           | Iout                      | Input Voltage  | Package L x W x H (mm)                 | Efficiency | Model Number    |
|----------------|---------------------------|----------------|--|------------|-----------------|
| <b>14-33 V</b> | <b>Aluminum Substrate</b> |                |  |            |                 |
|                | <b>21.5 A</b>             | 24 V (18-36 V) | 4.6" x 2.4" x 0.5" (116.8 x 61 x 12.7) | 93%        | AGF600-24S28-6L |
|                | <b>21.5 A</b>             | 48 V (36-75 V) | 4.6" x 2.4" x 0.5" (116.8 x 61 x 12.7) | 93.5%      | AGF600-48S28-6L |
|                | <b>25 A</b>               | 48 V (36-75 V) | 4.6" x 2.4" x 0.5" (116.8 x 61 x 12.7) | 93%        | AGF700-48S30-6L |

## C-Class – Economy

The 1<sup>st</sup> generation C-Class non-isolated DC–DC converters are designed to provide good efficiency and performance.

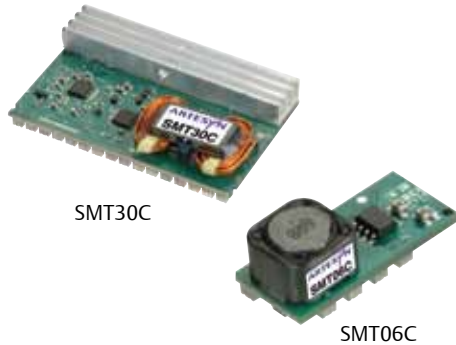

### Special Features

- Input voltage ranges: 4.5-5.5 V or 10.2-13.8 V
- Wide output voltage trim/adjustability: 0.9 to 5 Vdc
- Output current: 6-40 A
- High efficiency up to 92%
- Remote on/off
- Power good
- Parallel operation/current share (SIL30C)
- Remote sense (SIL30C)
- Excellent transient response
- Operating temperature range for SIL20C2 and SIL40C2: 0 °C to 70 °C
- Protection: overcurrent/short-circuit
- Cost-optimized design – industry leading value
- Compact footprint, vertical, horizontal and horizontal SMT options
- International safety standard approvals – UL, CSA, TÜV & CB Report

### General-Purpose C-Class Non-Isolated DC–DC Converters

| Output Current                               | Input Voltage | Output Voltage | Efficiency | Package L x W x H (mm)                        | Model Number     |
|--|---------------|----------------|------------|---|------------------|
| <b>Single-In-Line, Through-Hole Mounting</b> |               |                |            |   |                  |
| 6 A  | 4.5-5.5 Vdc   | 0.9-3.3 V      | 89%        | 1.2" x 0.45" x 0.61" (30.48 x 11.43 x 15.49)  | SIL06C-05SADJ-VJ |
| 6 A  | 10.2-13.8 Vdc | 0.9-5.0 V      | 91%        | 1.2" x 0.45" x 0.61" (30.48 x 11.43 x 15.49)  | SIL06C-12SADJ-VJ |
| 15 A   | 4.5-5.5 Vdc   | 0.9-3.3 V      | 89%        | 1.2" x 0.4" x 1.1" (30.48 x 10.16 x 27.94)    | SIL15C-05SADJ-VJ |
| 15 A   | 10.2-13.8 Vdc | 0.9-5.0 V      | 91%        | 1.2" x 0.4" x 1.1" (30.48 x 10.16 x 27.94)    | SIL15C-12SADJ-VJ |
| 25 A   | 10.2-13.8 Vdc | -4.5-(-5.5 V)  | 90%        | 2.4" x 0.52" x 1.25" (60.96 x 13.21 x 31.75)  | SIL25C-12SNEG-VJ |
| 30 A   | 10.2-13.8 Vdc | 0.9-5.0 V      | 91%        | 2.4" x 0.52" x 1.25" (60.96 x 13.21 x 31.75)  | SIL30C-12SADJ-VJ |
| <b>Surface-Mounting</b>                      |               |                |            |   |                  |
| 6 A  | 4.5-5.5 Vdc   | 0.9-3.3 V      | 89%        | 1.2" x 0.53" x 0.47" (30.48 x 13.46 x 11.94)  | SMT06C-05SADJJ   |
| 6 A  | 10.2-13.8 Vdc | 0.9-5.0 V      | 91%        | 1.2" x 0.53" x 0.47" (30.48 x 13.46 x 11.94)  | SMT06C-12SADJJ   |
| 15 A   | 4.5-5.5 Vdc   | 0.9-3.3 V      | 89%        | 1.2" x 1.1" x 0.46" (30.48 x 27.94 x 11.68)   | SMT15C-05SADJJ   |
| 15 A   | 10.2-13.8 Vdc | 0.9-5.0 V      | 91%        | 1.2" x 1.1" x 0.46" (30.48 x 27.94 x 11.68)   | SMT15C-12SADJJ   |
| 30 A   | 10.2-13.8 Vdc | 0.9-5.0 V      | 91%        | 2.28" x 1.45" x 0.43" (57.91 x 36.83 x 10.92) | SMT30C-12SADJJ   |

## C-Class – High Density

The 2<sup>nd</sup> generation C-Class non-isolated DC–DC converters are designed to provide good efficiency and performance, a smaller footprint, and integrated input and output capacitors.

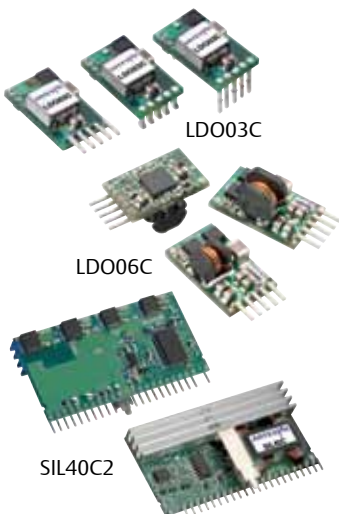

### Special Features

- Wide input voltage ranges: 3-13.8 V or 4.5-13.8 V
- Wide output voltage trim/adjustability: 0.59-5.1 V
- Output current: 3-40 A
- High efficiency up to 94%
- Remote on/off
- Power good
- Remote sense (Sxx20C2, Sxx40C2 and Sxx60C2)
- Excellent transient response
- Current sink capability for termination applications
- Operating temperature range for LDO03, LDO06, LDO10: -40 °C to 85 °C.
- Operating temperature range for SIL/SMT20C2, SIL/SMT40C2 and SIL60C2: 0 °C to 70 °C
- Operating temperature range for SIL/SMT80C2: 0 °C to 85 °C
- Protection: over current/short-circuit
- No added input or output capacitors needed for ripple current capability or stability
- Cost-optimized design – industry leading value
- Compact footprint, vertical, horizontal and horizontal SMT options
- International safety standard approvals – UL, CSA, TÜV & CB Report

## General-Purpose C-Class Non-Isolated DC-DC Converters

| Output Current                               | Input Voltage | Output Voltage | Efficiency | Package L x W x H (mm)                        | Model Number       |
|--|---------------|----------------|------------|---|--------------------|
| <b>Single-In-Line, Through-Hole Mounting</b> |               |                |            |   |                    |
| 3 A  | 3.0-13.8 Vdc  | 0.59-5.1 V     | 90%        | 0.37" x 0.21" x 0.61" (9.4 x 5.33 x 15.49)    | LDO03C-005W05-VJ   |
| 6 A  | 3.0-13.8 Vdc  | 0.59-5.1 V     | 92%        | 0.41" x 0.37" x 0.65" (10.41 x 9.4 x 16.51)   | LDO06C-005W05-VJ   |
| 10 A   | 3.0-13.8 Vdc  | 0.59-5.1 V     | 94%        | 0.41" x 0.45" x 0.65" (10.41 x 11.43 x 16.51) | LDO10C-005W05-VJ   |
| 20 A   | 4.5-13.8 Vdc  | 0.59-5.1 V     | 93%        | 1.2" x 0.46" x 0.61" (30.48 x 11.68 x 15.49)  | SIL20C2-00SADJ-VJ  |
| 40 A   | 4.5-13.8 Vdc  | 0.6-5.0 V      | 94%        | 1.2" x 0.43" x 1.1" (30.48 x 10.92 x 27.94)   | SIL40C2-00SADJ-VJ  |
| <b>NEW!</b> 60 A                             | 10.8-13.2 Vdc | 1.2-4.0V       | 89%        | 1.98" x 0.54" x 0.78" (50.29 x 13.72 x 19.81) | SIL60C2-00SADJ-VDJ |
| <b>NEW!</b> 80 A                             | 4.7-13.8 Vdc  | 0.84-5.0 V     | 93%        | 2.4" x 0.7" x 1.25" (60.96 x 17.78 x 31.75)   | SIL80C2-00SADJ-VJ  |
| <b>Surface-Mounting</b>                      |               |                |            |   |                    |
| 3 A  | 3.0-13.8 Vdc  | 0.59-5.1 V     | 90%        | 0.61" x 0.37" x 0.29" (15.49 x 9.4 x 7.37)    | LDO03C-005W05-SJ   |
| 6 A  | 3.0-13.8 Vdc  | 0.59-5.1 V     | 92%        | 0.65" x 0.41" x 0.44" (16.51 x 10.41 x 11.18) | LDO06C-005W05-SJ   |
| 10 A   | 3.0-13.8 Vdc  | 0.59-5.1 V     | 94%        | 0.65" x 0.41" x 0.52" (16.51 x 10.41 x 13.21) | LDO10C-005W05-SJ   |
| 20 A   | 4.5-13.8 Vdc  | 0.59-5.1 V     | 93%        | 1.2" x 0.61" x 0.48" (30.48 x 15.49 x 12.19)  | SMT20C2-00SADJJ    |
| 40 A   | 4.5-13.8 Vdc  | 0.6-5.0 V      | 94%        | 1.2" x 1.1" x 0.44" (30.48 x 27.94 x 11.18)   | SMT40C2-00SADJJ    |
| <b>NEW!</b> 80 A                             | 4.5-13.8 Vdc  | 0.84-5.1V      | 88%        | 2.4" x 1.25" x 0.7" (60.96 x 31.75 x 18.03)   | SMT80C2-00SADJ-J   |

## C-Class – High Density LGA C Series

The latest addition to the C-Class non-isolated DC-DC converter offering packaged in an ultra-compact, low-profile Land Grid Array with current densities up to 225 A/in<sup>3</sup>.



### Special Features

- High density, ultra low profile surface mount module in Land Grid Array (LGA) package
- Available in 4 different output current levels: 3, 6, 10 and 20 Amps
- Wide input voltage range: 3.0-14.0 V
- Adjustable output voltage: 0.59-5.1 V via external resistor
- High efficiency ~92% typical
- Wide ambient operating temperature range: -40 °C to 85 °C
- Input UVLO; Remote On/Off; Output Adjust; Margin; PGood signal, Differential sense
- Current sink capability for voltage termination applications
- Integrated input and output capacitors resulting in minimal external capacitance required for stable operation

## LGA C Series Non-Isolated DC-DC Converters

| Output Current          | Input Voltage | Output Voltage | Efficiency | Package L x W x H (mm)                        | Model Number   |
|-------------------------|---------------|----------------|------------|---|----------------|
| <b>Surface-Mounting</b> |               |                |            |   |                |
| 3 A                     | 3.0-14 Vdc    | 0.59-5.1 V     | 92%        | 0.65" x 0.65" x 0.129" (16.51 x 16.51 x 3.27) | LGA03C-00SADJJ |
| 6 A                     | 3.0-14 Vdc    | 0.59-5.1 V     | 92%        | 0.65" x 0.65" x 0.129" (16.51 x 16.51 x 3.27) | LGA06C-00SADJJ |
| 10 A                    | 3.0-14 Vdc    | 0.59-5.1 V     | 92%        | 0.65" x 0.65" x 0.129" (16.51 x 16.51 x 3.27) | LGA10C-00SADJJ |
| 20 A                    | 4.5-14 Vdc    | 0.59-5.1 V     | 91%        | 0.65" x 0.65" x 0.210" (16.51 x 16.51 x 5.33) | LGA20C-01SADJJ |

Note: Optional heatsink kits are available. Ordering part number is LGA-HTSK-KIT-XXX

XXX = Total height of the LGA20C-01SADJJ with heatsink attached: 045 = 0.45"; 048 = 0.48"; 050 = 0.50"

# E-Class – Performance

Efficiencies as high as 96% and current densities up to 140 A/in<sup>3</sup>.



SIL05E

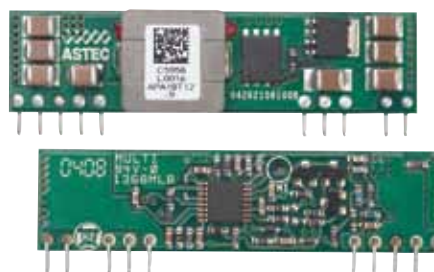

APA18

## Special Features

Efficiencies as high as 96% and current densities up to 140 A/in<sup>3</sup>.

- Input voltage ranges: 3-5.5 V, 4.5-5.5 V, 8-14 V, 10-14 V
- Wide output voltage trim ranges: 0.8-3.63 V and 0.75-5.5 V
- Output current: 5-30 A
- Remote on/off
- Remote sense

- Industry standard footprint—vertical and horizontal mounting (low profile SMT/SIP—through-hole)
- Operating temperature range: -40 °C to 85 °C
- Protection: overcurrent/short-circuit
- International safety standard approvals –UL, CSA, TÜV & CB Report

## General-Purpose E-Class Non-Isolated DC–DC Converters

| Output Current                               | Input Voltage | Output Voltage | Efficiency | Package L x W x H (mm)                      | Model Number     |
|--|---------------|----------------|------------|---|------------------|
| <b>Single-In-Line, Through-hole Mounting</b> |               |                |            |   |                  |
| 5 A  | 3.0-5.5 Vdc   | 0.75-3.63 V    | 94%        | 0.9" x 0.28" x 0.4" (22.86 x 7.11 x 10.16)  | SIL05E-05W3V3-VJ |
| 10 A   | 4.5-5.5 Vdc   | 0.8-3.63 V     | 95%        | 2" x 0.31" x 0.5" (50.8 x 7.87 x 12.7)      | SIL10E-05W3V3-VJ |
| 10 A   | 10-14 Vdc     | 0.8-3.63 V     | 94%        | 2" x 0.31" x 0.5" (50.8 x 7.87 x 12.7)      | SIL10E-12W3V3-VJ |
| 15 A   | 3.0-5.5 Vdc   | 0.8-3.63 V     | 94%        | 2" x 0.31" x 0.5" (50.8 x 7.87 x 12.7)      | SIL15E-05W3V3-VJ |
| 15 A   | 10-14 Vdc     | 0.8-3.63 V     | 94%        | 2" x 0.31" x 0.5" (50.8 x 7.87 x 12.7)      | SIL15E-12W3V3-VJ |
| 18 A   | 3.0-5.5 Vdc   | 0.75-3.6 V     | 92%        | 2" x 0.39" x 0.5" (50.8 x 9.91 x 12.7)      | APA18T04-9L      |
| 18 A   | 10-14 Vdc     | 0.75-3.6 V     | 92%        | 2" x 0.39" x 0.5" (50.8 x 9.91 x 12.7)      | APA18T12-9L      |
| 30 A   | 8.0-14 Vdc    | 0.8-3.63 V     | 93%        | 2" x 0.31" x 0.5" (50.8 x 7.87 x 12.7)      | SIL30E-12W3V3-VJ |
| <b>Surface-Mounting</b>                      |               |                |            |   |                  |
| 5 A  | 3.0-5.5 Vdc   | 0.75-3.63 V    | 94%        | 0.8" x 0.45" x 0.26" (20.32 x 11.43 x 6.6)  | SMT05E-05W3V3J   |
| 5 A  | 10-14 Vdc     | 0.8-3.63 V     | 91%        | 0.8" x 0.45" x 0.24" (20.32 x 11.43 x 6.1)  | SMT05E-12W3V3J   |
| 10 A   | 3.0-5.5 Vdc   | 0.8-3.63 V     | 96%        | 1.3" x 0.53" x 0.32" (33.02 x 13.46 x 8.13) | SMT10E-05W3V3J   |
| 10 A   | 10-14 Vdc     | 0.8-3.63 V     | 94%        | 1.3" x 0.53" x 0.32" (33.02 x 13.46 x 8.13) | SMT10E-12W3V3J   |
| 15 A   | 3.0-5.5 Vdc   | 0.8-3.63 V     | 95%        | 1.3" x 0.53" x 0.32" (33.02 x 13.46 x 8.13) | SMT15E-05W3V3J   |
| 15 A   | 10-14 Vdc     | 0.8-3.63 V     | 94%        | 1.3" x 0.53" x 0.32" (33.02 x 13.46 x 8.13) | SMT15E-12W3V3J   |
| 18 A   | 3.0-5.5 Vdc   | 0.75-3.63 V    | 92%        | 1.3" x 0.53" x 0.34 (33.02 x 13.46 x 8.64)  | APC18T04-9L      |
| 18 A   | 10-14 Vdc     | 0.75-5.5 V     | 92%        | 1.3" x 0.53" x 0.34 (33.02 x 13.46 x 8.64)  | APC18T12-9L      |
| 30 A   | 8.0-14 Vdc    | 0.8-3.63 V     | 91%        | 1.3" x 0.53" x 0.32" (33.02 x 13.46 x 8.13) | SMT30E-12W3V3J   |

# F-Class – Fast Transient Response

Highly integrated non-isolated DC-DC modules, combining transient response up to 300 A/ $\mu$ s. Expressly designed to minimize the number of external capacitors needed.

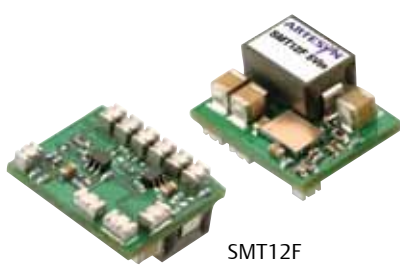

## Special Features

- Input voltage ranges: 3-5.5 Vdc, 10.8-13.2 Vdc
- Wide output voltage trim range: 0.9-3.3 V (SMT12F)
- Output current: 12-15 A
- High efficiency: 95% @ 5 V in 3.3 Vdc output/full load
- Remote on/off
- Differential remote sense
- Power good
- Separate digital inputs for +5% and -5% output voltage margining
- Industry standard surface-mount footprint (SMT15F)
- Current densities in excess of 72 A/in<sup>3</sup>
- Operating temperature range: -40 °C to 85 °C
- Protection: overcurrent/short-circuit (non-latching) and overtemperature
- International safety standard approvals – UL, CSA, TÜV & CB Report

## General-Purpose F-Class Non-Isolated DC-DC Converters

| Output Current          | Input Voltage | Output Voltage | Efficiency | Package L x W x H (mm)                     | Model Number   |
|-------------------------|---------------|----------------|------------|--|----------------|
| <b>Surface-Mounting</b> |               |                |            |  |                |
| 12 A                    | 3-5.5 Vdc     | 0.9-3.3 V      | 95%        | 0.63" x 0.52" x 0.31" (16 x 13.21 x 7.87)  | SMT12F-05W3V3J |
| 15 A                    | 10.8-13.2 Vdc | 1.0 V          | 85%        | 1.3" x 0.53" x 0.3" (33.02 x 13.46 x 7.62) | SMT15F-12S1V0J |
| 15 A                    | 10.8-13.2 Vdc | 1.2 V          | 86%        | 1.3" x 0.53" x 0.3" (33.02 x 13.46 x 7.62) | SMT15F-12S1V2J |
| 15 A                    | 10.8-13.2 Vdc | 1.5 V          | 87%        | 1.3" x 0.53" x 0.3" (33.02 x 13.46 x 7.62) | SMT15F-12S1V5J |
| 15 A                    | 10.8-13.2 Vdc | 1.8 V          | 88%        | 1.3" x 0.53" x 0.3" (33.02 x 13.46 x 7.62) | SMT15F-12S1V8J |

## A Paradigm Shift in Converter Packaging

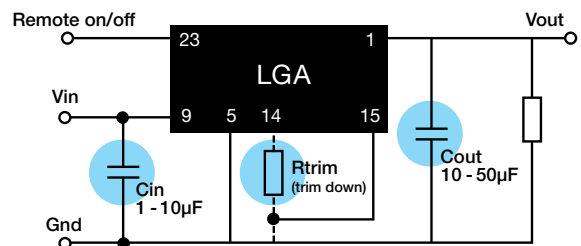
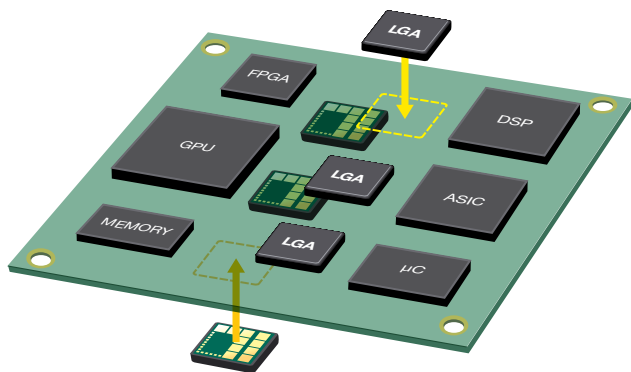

- Compact LGA package - significant improvement in current density, saves board space
- Allows for bilateral thermal management not easily provided by "down" solutions or typical modules (e.g., uniform height for coldplate cooling)
- Scalable solution, one footprint design for 3, 6, 10 and 20 A offering
- Fully operational DC-DC solution with 3 external components



# POLA – General Purpose

Choose POLA modules for multi-sourced and interoperable parts.

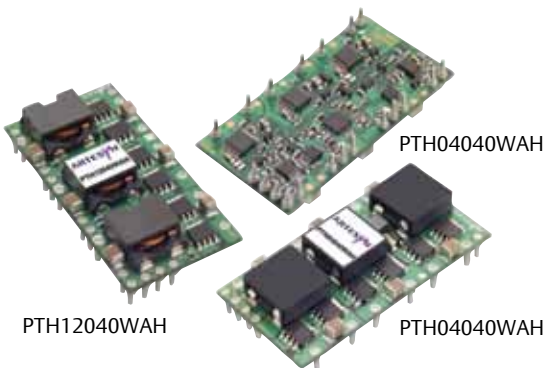

## Special Features

- Input voltage ranges: 2.95-3.65 V, 4.5-5.5 V, 10.8-13.2 V
- Wide output voltage trim and adjustability: 0.8-5.5 V
- Output current: 6-60 A
- High efficiency up to 96%
- Auto-Track™ Sequencing
- Margin up/down controls
- Pre-bias start up capability
- Remote on/off
- Remote sense
- POLA compatible
- True multi-sourcing flexibility (form, fit and function)
- Operating temperature range: -40 °C to 85 °C
- Protection: overcurrent/short-circuit
- Through-hole or surface-mount
- International safety standard approvals – UL, CSA, TÜV & CB Report

## General Purpose POLA Non-Isolated DC-DC Converters

| Output Current | Input Voltage | Output Voltage | Efficiency | Package L x W x H (mm)                          | Model Number* |
|----------------|---------------|----------------|------------|---|---------------|
| 6 A            | 2.95-3.65 Vdc | 0.8-2.5 V      | 94%        | 0.87" x 0.495" x 0.335" (22.01 x 12.57 x 8.51)  | PTH03050WAD   |
| 6 A            | 4.5-5.5 Vdc   | 0.8-3.6 V      | 95%        | 0.87" x 0.495" x 0.335" (22.01 x 12.57 x 8.51)  | PTH05050WAD   |
| 6 A            | 10.8-13.2 Vdc | 1.2-5.5 V      | 93%        | 0.87" x 0.495" x 0.335" (22.01 x 12.57 x 8.51)  | PTH12050WAD   |
| 8 A            | 2.95-3.65 Vdc | 0.8-2.5 V      | 93%        | 0.9" x 0.33" x 0.4" (22.86 x 8.38 x 10.16)      | PTV03010WAD   |
| 8 A            | 4.5-5.5 Vdc   | 0.8-3.6 V      | 95%        | 0.9" x 0.33" x 0.4" (22.86 x 8.38 x 10.16)      | PTV05010WAD   |
| 8 A            | 10.8-3.2 Vdc  | 1.2-5.5 V      | 92%        | 0.9" x 0.33" x 0.4" (22.86 x 8.38 x 10.16)      | PTV12010WAD   |
| 10 A           | 2.95-3.65 Vdc | 0.8-2.5 V      | 93%        | 0.995" x 0.62" x 0.354" (25.27 x 15.75 x 8.99)  | PTH03060WAD   |
| 10 A           | 4.5-5.5 Vdc   | 0.8-3.6 V      | 94%        | 0.995" x 0.62" x 0.354" (25.27 x 15.75 x 8.99)  | PTH05060WAD   |
| 10 A           | 10.8-3.2 Vdc  | 1.2-5.5 V      | 94%        | 0.995" x 0.62" x 0.354" (25.27 x 15.75 x 8.99)  | PTH12060WAD   |
| 12 A           | 10.8-13.2 Vdc | 1.2-5.5 V      | 94%        | 1.370" x 0.62" x 0.354" (34.80 x 15.75 x 8.99)  | PTH12010WAD   |
| 15 A           | 2.95-3.65 Vdc | 0.8-2.5 V      | 93%        | 1.370" x 0.62" x 0.354" (34.80 x 15.75 x 8.99)  | PTH03010WAD   |
| 15 A           | 4.5-5.5 Vdc   | 0.8-3.6 V      | 95%        | 1.370" x 0.62" x 0.354" (34.80 x 15.75 x 8.99)  | PTH05010WAD   |
| 16 A           | 10.8-13.2 Vdc | 1.2-5.5 V      | 93%        | 1.750" x 0.37" x 0.500" (44.45 x 9.4 x 12.7)    | PTV12020WAD   |
| 18 A           | 2.95-3.6 Vdc  | 0.8-2.5 V      | 95%        | 1.750" x 0.37" x 0.500" (44.45 x 9.4 x 12.7)    | PTV03020WAD   |
| 18 A           | 4.5-5.5 Vdc   | 0.8-3.6 V      | 94%        | 1.750" x 0.37" x 0.500" (44.45 x 9.4 x 12.7)    | PTV05020WAD   |
| 18 A           | 10.8-13.2 Vdc | 1.2-5.5 V      | 95%        | 1.495" x 0.87" x 0.354" (37.97 x 22.01 x 8.99)  | PTH12020WAD   |
| 22 A           | 2.95-3.65 Vdc | 0.8-2.5 V      | 95%        | 1.495" x 0.87" x 0.354" (37.97 x 22.01 x 8.99)  | PTH03020WAD   |
| 22 A           | 4.5-5.5 Vdc   | 0.8-3.6 V      | 96%        | 1.495" x 0.87" x 0.354" (37.97 x 22.01 x 8.99)  | PTH05020WAD   |
| 26 A           | 10.2-13.8 Vdc | 1.2-5.5 V      | 95%        | 1.37" x 1.12" x 0.354" (34.80 x 28.45 x 8.99)   | PTH12030WAD   |
| 30 A           | 2.95-3.65 Vdc | 0.8-2.5 V      | 93%        | 1.37" x 1.12" x 0.354" (34.80 x 28.45 x 8.99)   | PTH03030WAD   |
| 30 A           | 4.5-5.5 Vdc   | 0.8-3.6 V      | 94%        | 1.37" x 1.12" x 0.354" (34.80 x 28.45 x 8.99)   | PTH05030WAD   |
| 50 A           | 8.0-14 Vdc    | 0.8-5.5 V      | 96%        | 2.045" x 1.045" x 0.357" (51.94 x 26.54 x 9.07) | PTH12040WAD   |
| 60 A           | 2.95-2.5 Vdc  | 0.8-2.5 V      | 96%        | 2.045" x 1.045" x 0.357" (51.94 x 26.54 x 9.07) | PTH04040WAD   |

\*Mounting Option Suffix:

D Horizontal through-hole (RoHS 6/6)

Z Surface-mount solder ball (RoHS 6/6)



## Voltage Regulator Modules (VRM)

Emerson Network Power closely tracks leading semiconductor manufacturers' (Intel®) roadmaps and offer processor power converters designed specifically to match demands.



### Special Features

- Voltage regulator modules (VRMs) for Intel
- Input voltage ranges: 10.8-13.2 V, 11-12.6 V and 11-13.2 V
- Output currents up to 105 A
- Output voltage adjustability
- 5-bit and 6-bit VID inputs
- Allows dynamic VID code changes
- High efficiency up to 87%
- Exceptionally fast transient response in excess of 900 A/ $\mu$ s
- Remote on/off
- Differential remote sense
- Low profile to meet 1U applications
- Current sharing – no need for master/slave configurations
- Protection: overcurrent/short-circuit/overvoltage (with on-board fuse)
- International safety standard approvals – VDE

### VRM Processor Non-Isolated DC–DC Converters

| VRM Specifications | Output Current | Input Voltage | Output Voltage | Efficiency | Package L x W x H (mm)                        | Model Number    |
|--------------------|----------------|---------------|----------------|------------|---|-----------------|
| VRM10.0, VRM10.1   | <b>105 A</b>   | 11-12.6 Vdc   | 0.8375-1.60 V  | 84%        | 3.68" x 1.00" x 1.25" (93.35 x 25.4 x 31.75)  | VRM10-105-12-EJ |
| VRM10.0, VRM10.1   | <b>80 A</b>    | 11-12.6 Vdc   | 0.8375-1.60 V  | 85%        | 3.19" x 0.77" x 1.24" (81.03 x 19.78 x 31.75) | VRM10-80-12-PJ  |
| VRM10.0, VRM10.1   | <b>85 A</b>    | 11-12.6 Vdc   | 0.8375-1.60 V  | 85%        | 3.19" x 0.77" x 1.24" (81.03 x 19.78 x 31.75) | VRM10-85-12-UJ  |

# On-board AC-DC Distributed Architecture

- High power and high density AC-DC building blocks for quick-turn and modular power solutions
- Alternative power solutions vs. custom development approach
- No fans and high reliability (1M hours MTBF)
- Suitable for harsh temperature conditions (-40 °C startup/-20 °C to 100 °C operating temperature)

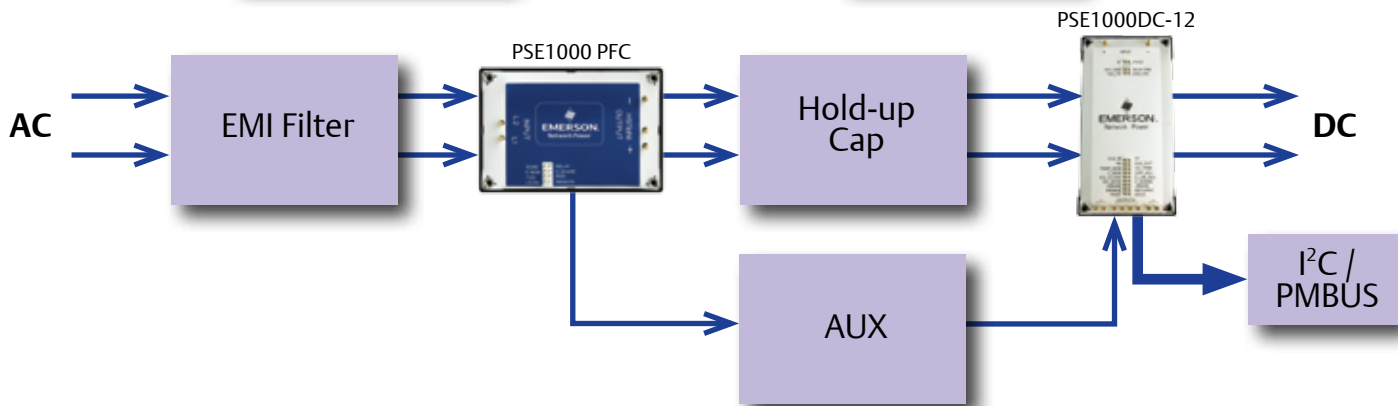
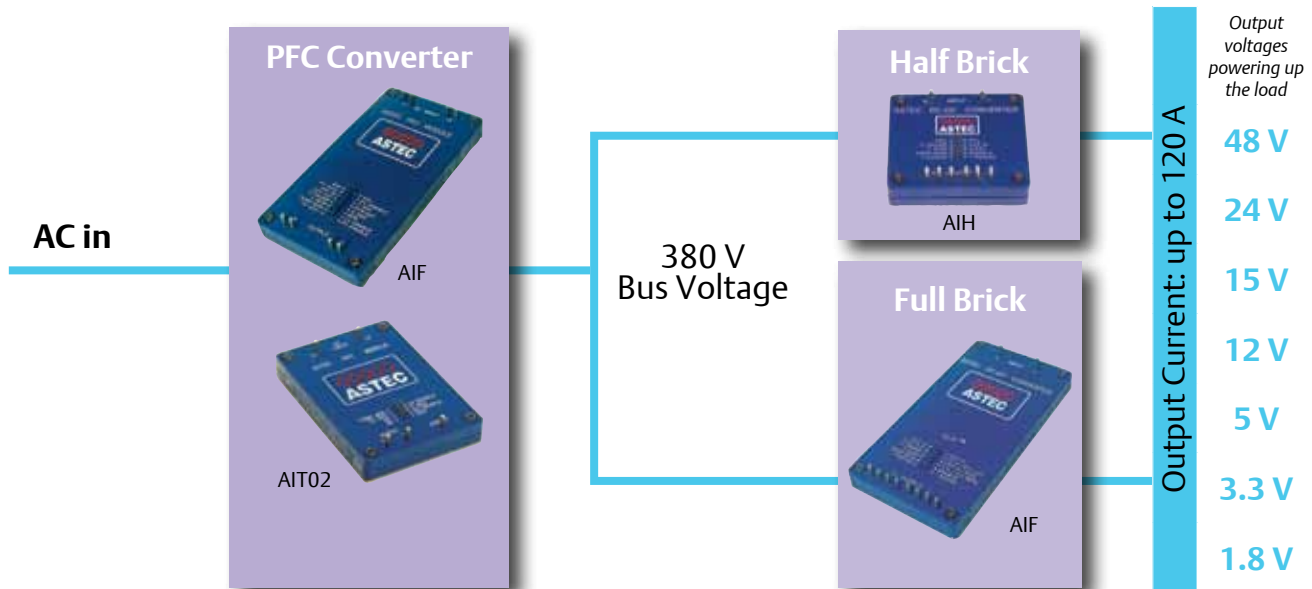

# Power Factor Correction (PFC)



## Special Features

- 1600 W/720 W/75 W
- Unity power factor
- Universal input and frequency range
- Positive and negative enable
- Paralleling with current share
- IEC 1000-3.2 compliance
- 100 °C baseplate
- Clock synch (in/out)
- Current monitoring
- Vout adjust
- On/off enable
- Remote sense
- 95% efficiency
- Fast transient response

| Vout                          | Iout   | Input Voltage | Package L x W x H (mm)                     | Efficiency | Model Number   |
|-------------------------------|--------|---------------|--|------------|----------------|
| <b>PFC Module - Baseplate</b> |        |               |  |            |                |
| 380 V                         | 4.2 A  | 85-264 Vac    | 4.6" x 2.4" x 0.5" (116.84 x 60.96 x 12.7) | 95%        | AIF04ZPFC-01L  |
| 380 V                         | 4.2 A  | 85-264 Vac    | 4.6" x 2.4" x 0.5" (116.84 x 60.96 x 12.7) | 95%        | AIF04ZPFC-02L  |
| 393 V                         | 0.25 A | 100-122 Vac   | 2.3" x 1.45" x 0.5" (57.91 x 36.83 x 12.7) | 90%        | AIQ00ZPFC-01NL |
| 393 V                         | 2.08 A | 85-264 Vac    | 3.5" x 2.4" x 0.5" (88.9 x 60.96 x 12.7)   | 93%        | AIT02ZPFC-01NL |
| 393 V                         | 0.35 A | 100-122 Vac   | 3.5" x 2.4" x 0.5" (88.9 x 60.96 x 12.7)   | 91%        | AIT00ZPFC-01NL |
| <b>NEW!</b> 390 V             | 2.56 A | 90-264 Vac    | 3.5" x 2.4" x 1" (88.9 x 61 x 25.8)        | 94%        | PSE1000PFC*    |

\*85°C temperature

# High Power 300 Vin



300 V input 65-600 W output

## Special Features

- 300 V input (250-420 V PFC-ready)
- 2nd generation product
- Standard through-hole termination
- Power density >100 W/in<sup>3</sup>
- 100 °C max baseplate operating temperature
- Embedded controls on secondary side (Full- and Half-brick):
  - Temp monitor
  - Current sharing
  - Power good signal
  - Current limit & OVP adjust

|                    | Vout                                   | Iout      | Input Voltage                        | Package L x W x H (mm)                     | Efficiency    | Model Number |
|--------------------|--|-----------|--------------------------------------|--|---------------|--------------|
| <b>AIF 300 Vin</b> | <b>Full-Brick – Baseplate</b>          |           |                                      |  |               |              |
|                    | 1.8 V                                  | 120 A     | 300 V (250-420 V)                    | 4.6" x 2.4" x 0.5" (116.84 x 60.96 x 12.7) | 80%           | AIF120Y300-L |
|                    | 3.3 V                                  | 120 A     | 300 V (250-420 V)                    | 4.6" x 2.4" x 0.5" (116.84 x 60.96 x 12.7) | 87%           | AIF120F300-L |
|                    | 5 V                                    | 80 A      | 300 V (250-420 V)                    | 4.6" x 2.4" x 0.5" (116.84 x 60.96 x 12.7) | 90%           | AIF80A300-L  |
|                    | 12 V                                   | 50 A      | 300 V (250-420 V)                    | 4.6" x 2.4" x 0.5" (116.84 x 60.96 x 12.7) | 90%           | AIF50B300-L  |
|                    | 15 V                                   | 40 A      | 300 V (250-420 V)                    | 4.6" x 2.4" x 0.5" (116.84 x 60.96 x 12.7) | 90%           | AIF40C300-L  |
|                    | 24 V                                   | 25 A      | 300 V (250-420 V)                    | 4.6" x 2.4" x 0.5" (116.84 x 60.96 x 12.7) | 90%           | AIF25H300-L  |
|                    | 48 V                                   | 12 A      | 300 V (250-420 V)                    | 4.6" x 2.4" x 0.5" (116.84 x 60.96 x 12.7) | 91%           | AIF12W300-L  |
| <b>PSE1000DC</b>   | <b>Full-Brick – Baseplate</b>          |           |                                      |  |               |              |
| 12 V               | 83 A                                   | 370-390 V | 4.6" x 2.4" x 1" (116.8 x 61 x 25.5) |  | PSE1000DC-12* |              |
| <b>AIT 300 Vin</b> | <b>Three-Quarter-Brick – Baseplate</b> |           |                                      |  |               |              |
|                    | 28 V/3.3 V                             | 3.9A/4.5A | 390 V (375-410 V)                    | 3.6" x 2.4" x 0.5" (91.44 x 60.96 x 12.7)  | 87%           | AIT04RF300-L |
| <b>AIH 300 Vin</b> | <b>Half-Brick – Baseplate</b>          |           |                                      |  |               |              |
|                    | 1.8 V                                  | 50 A      | 300 V (250-420 V)                    | 2.3" x 2.4" x 0.5" (58.42 x 60.96 x 12.7)  | 80%           | AIH50Y300-L  |
|                    | 3.3 V                                  | 50 A      | 300 V (250-420 V)                    | 2.3" x 2.4" x 0.5" (58.42 x 60.96 x 12.7)  | 85%           | AIH50F300-L  |
|                    | 5 V                                    | 40 A      | 300 V (250-420 V)                    | 2.3" x 2.4" x 0.5" (58.42 x 60.96 x 12.7)  | 88%           | AIH40A300-L  |
|                    | 12 V                                   | 20 A      | 300 V (250-420 V)                    | 2.3" x 2.4" x 0.5" (58.42 x 60.96 x 12.7)  | 90%           | AIH20B300-L  |
|                    | 15 V                                   | 16 A      | 300 V (250-420 V)                    | 2.3" x 2.4" x 0.5" (58.42 x 60.96 x 12.7)  | 90%           | AIH16C300-L  |
| <b>AIQ 300 Vin</b> | <b>Quarter-Brick – Baseplate</b>       |           |                                      |  |               |              |
|                    | 28 V                                   | 2.32 A    | 300 V (250-420 V)                    | 2.3" x 1.45" x 0.5" (57.91 x 36.83 x 12.7) | 89%           | AIQ02R300L   |

\* 85°C temperature

For complete product specifications, technical reference notes and available product options, go to [www.Emerson.com/EmbeddedPower](http://www.Emerson.com/EmbeddedPower).

# Low Power Isolated DC-DC Product



## Special Features

- Input voltages 9-36 V, 18-36 V, 18-75 V and 36-75 V
- Single and dual outputs
- Power 6-30 W
- Regulated outputs
- Operating temperature -40 °C to 71 °C (ambient)
- Overcurrent protection
- 1500 Vdc isolation
- CE Mark Safety (UL Pending)

|             | Input Voltage   | Output Voltage                                  | Package L x W x H (mm)                          | I/O Isolation | Efficiency   | Model Number |
|-------------|-----------------|---|---|---------------|--------------|--------------|
| <b>6 W</b>  | <b>Enclosed</b> |   |   |               |              |              |
|             | 9-36 V          | 12 V @ 0.5 A                                    | DIP 1.25" x 0.8" x 0.4" (31.75 x 20.32 x 10.16) | 1500 Vdc      | 82%          | ASA00B18-L   |
|             | 9-36 V          | 15 V @ 0.4 A                                    | DIP 1.25" x 0.8" x 0.4" (31.75 x 20.32 x 10.16) | 1500 Vdc      | 83%          | ASA00C18-L   |
|             | 9-36 V          | 5 V @ 1 A                                       | DIP 1.25" x 0.8" x 0.4" (31.75 x 20.32 x 10.16) | 1500 Vdc      | 81%          | ASA01 A18-L  |
|             | 9-36 V          | 3.3 V @ 1.2 A                                   | DIP 1.25" x 0.8" x 0.4" (31.75 x 20.32 x 10.16) | 1500 Vdc      | 78%          | ASA01F18-L   |
|             | 9-36 V          | 5 V @ ±0.5 A                                    | DIP 1.25" x 0.8" x 0.4" (31.75 x 20.32 x 10.16) | 1500 Vdc      | 81%          | ASA00 AA18-L |
|             | 9-36 V          | 12 V @ ±0.25 A                                  | DIP 1.25" x 0.8" x 0.4" (31.75 x 20.32 x 10.16) | 1500 Vdc      | 82%          | ASA00BB18-L  |
|             | 9-36 V          | 15 V @ ±0.2 A                                   | DIP 1.25" x 0.8" x 0.4" (31.75 x 20.32 x 10.16) | 1500 Vdc      | 83%          | ASA00CC18-L  |
|             | 18-75 V         | 12 V @ 0.5 A                                    | DIP 1.25" x 0.8" x 0.4" (31.75 x 20.32 x 10.16) | 1500 Vdc      | 82%          | ASA00B36-L   |
|             | 18-75 V         | 15 V @ 0.4 A                                    | DIP 1.25" x 0.8" x 0.4" (31.75 x 20.32 x 10.16) | 1500 Vdc      | 83%          | ASA00C36-L   |
|             | 18-75 V         | 5 V @ 1 A                                       | DIP 1.25" x 0.8" x 0.4" (31.75 x 20.32 x 10.16) | 1500 Vdc      | 81%          | ASA01 A36-L  |
|             | 18-75 V         | 3.3 V @ 1.2 A                                   | DIP 1.25" x 0.8" x 0.4" (31.75 x 20.32 x 10.16) | 1500 Vdc      | 78%          | ASA01F36-L   |
|             | 18-75 V         | 5 V @ ±0.5 A                                    | DIP 1.25" x 0.8" x 0.4" (31.75 x 20.32 x 10.16) | 1500 Vdc      | 81%          | ASA00AA36-L  |
|             | 18-75 V         | 12 V @ ±0.25 A                                  | DIP 1.25" x 0.8" x 0.4" (31.75 x 20.32 x 10.16) | 1500 Vdc      | 82%          | ASA00BB36-L  |
| 18-75 V     | 15 V @ ±0.2 A   | DIP 1.25" x 0.8" x 0.4" (31.75 x 20.32 x 10.16) | 1500 Vdc  | 83%           | ASA00CC36-L  |              |
| <b>10 W</b> | <b>Enclosed</b> |   |   |               |              |              |
|             | 18-36 V         | 12 V @ 0.835 A                                  | DIP 1.25" x 0.8" x 0.4" (31.75 x 20.32 x 10.16) | 1500 Vdc      | 83%          | ASA00B24-L   |
|             | 18-36 V         | 5 V @ 2 A                                       | DIP 1.25" x 0.8" x 0.4" (31.75 x 20.32 x 10.16) | 1500 Vdc      | 82%          | ASA02 A24-L  |
|             | 18-36 V         | 3.3 V @ 3 A                                     | DIP 1.25" x 0.8" x 0.4" (31.75 x 20.32 x 10.16) | 1500 Vdc      | 79%          | ASA03F24-L   |
|             | 18-36 V         | 2.5 V @ 3 A                                     | DIP 1.25" x 0.8" x 0.4" (31.75 x 20.32 x 10.16) | 1500 Vdc      | 77%          | ASA03G24-L   |
|             | 36-75 V         | 12 V @ 0.835 A                                  | DIP 1.25" x 0.8" x 0.4" (31.75 x 20.32 x 10.16) | 1500 Vdc      | 83%          | ASA00B48-L   |
|             | 36-75 V         | 5 V @ 2 A                                       | DIP 1.25" x 0.8" x 0.4" (31.75 x 20.32 x 10.16) | 1500 Vdc      | 82%          | ASA02 A48-L  |
|             | 36-75 V         | 3.3 V @ 3 A                                     | DIP 1.25" x 0.8" x 0.4" (31.75 x 20.32 x 10.16) | 1500 Vdc      | 79%          | ASA03F48-L   |
| 36-75 V     | 2.5 V @ 3 A     | DIP 1.25" x 0.8" x 0.4" (31.75 x 20.32 x 10.16) | 1500 Vdc  | 87%           | ASA03G48-L   |              |
| <b>15 W</b> | <b>Enclosed</b> |   |   |               |              |              |
|             | 9-36 V          | 12 V @ 1.25 A                                   | 1" x 2" x 0.44" (25.4 x 50.8 x 11.30)           | 1500 Vdc      | 84%          | AEE01B18-L   |
|             | 9-36 V          | 15 V @ 1 A                                      | 1" x 2" x 0.44" (25.4 x 50.8 x 11.30)           | 1500 Vdc      | 84%          | AEE01C18-L   |
|             | 9-36 V          | 3.3 V @ 4 A                                     | 1" x 2" x 0.44" (25.4 x 50.8 x 11.30)           | 1500 Vdc      | 80%          | AEE04F18-L   |
|             | 9-36 V          | 5 V @ 3 A                                       | 1" x 2" x 0.44" (25.4 x 50.8 x 11.30)           | 1500 Vdc      | 84%          | AEE03 A18-L  |
|             | 9-36 V          | 12 V @ ±0.625 A                                 | 1" x 2" x 0.44" (25.4 x 50.8 x 11.30)           | 1500 Vdc      | 83%          | AEE00BB18-L  |
|             | 9-36 V          | 15 V @ ±0.5 A                                   | 1" x 2" x 0.44" (25.4 x 50.8 x 11.30)           | 1500 Vdc      | 83%          | AEE00CC18-L  |
|             | 9-36 V          | 5 V @ ±1.5 A                                    | 1" x 2" x 0.44" (25.4 x 50.8 x 11.30)           | 1500 Vdc      | 79%          | AEE01 AA18-L |
|             | 18-75 V         | 12 V @ 1.25 A                                   | 1" x 2" x 0.44" (25.4 x 50.8 x 11.30)           | 1500 Vdc      | 84%          | AEE01B36-L   |
|             | 18-75 V         | 15 V @ 1 A                                      | 1" x 2" x 0.44" (25.4 x 50.8 x 11.30)           | 1500 Vdc      | 84%          | AEE01C36-L   |
|             | 18-75 V         | 3.3 V @ 4 A                                     | 1" x 2" x 0.44" (25.4 x 50.8 x 11.30)           | 1500 Vdc      | 80%          | AEE04F36-L   |
|             | 18-75 V         | 5 V @ 3 A                                       | 1" x 2" x 0.44" (25.4 x 50.8 x 11.30)           | 1500 Vdc      | 84%          | AEE03 A36-L  |
|             | 18-75 V         | 12 V @ ±0.625 A                                 | 1" x 2" x 0.44" (25.4 x 50.8 x 11.30)           | 1500 Vdc      | 83%          | AEE00BB36-L  |
|             | 18-75 V         | 15 V @ ±0.5 A                                   | 1" x 2" x 0.44" (25.4 x 50.8 x 11.30)           | 1500 Vdc      | 83%          | AEE00CC36-L  |
| 18-75 V     | 5 V @ ±1.5 A    | 1" x 2" x 0.44" (25.4 x 50.8 x 11.30)           | 1500 Vdc  | 79%           | AEE01 AA36-L |              |

|                | Input Voltage   | Output Voltage                          | Package L x W x H (mm)                  | I/O Isolation | Efficiency  | Model Number |
|----------------|-----------------|---|---|---------------|-------------|--------------|
| <b>20 W</b>    | <b>Enclosed</b> |   |   |               |             |              |
|                | <b>9-36 V</b>   | 2.5V @ 6A                               | 1.6" x 2" x 0.48" (40.6 x 50.8 x 12.19) | 1500 Vdc      | 79%         | AET06G18-L   |
|                | <b>9-36 V</b>   | 3.3V @ 6A                               | 1.6" x 2" x 0.48" (40.6 x 50.8 x 12.19) | 1500 Vdc      | 83%         | AET06F18-L   |
|                | <b>9-36 V</b>   | 5V @ 4A                                 | 1.6" x 2" x 0.48" (40.6 x 50.8 x 12.19) | 1500 Vdc      | 84%         | AET04A18-L   |
|                | <b>9-36 V</b>   | 12V @ 1.67A                             | 1.6" x 2" x 0.48" (40.6 x 50.8 x 12.19) | 1500 Vdc      | 85%         | AET01B18-L   |
|                | <b>9-36 V</b>   | 15V @ 1.33A                             | 1.6" x 2" x 0.48" (40.6 x 50.8 x 12.19) | 1500 Vdc      | 85%         | AET01C18-L   |
|                | <b>9-36 V</b>   | 5V @ ±2A                                | 1.6" x 2" x 0.48" (40.6 x 50.8 x 12.19) | 1500 Vdc      | 84%         | AET02AA18-L  |
|                | <b>9-36 V</b>   | 12V @ ±0.835A                           | 1.6" x 2" x 0.48" (40.6 x 50.8 x 12.19) | 1500 Vdc      | 85%         | AET00BB18-L  |
|                | <b>9-36 V</b>   | 15V @ ±0.665A                           | 1.6" x 2" x 0.48" (40.6 x 50.8 x 12.19) | 1500 Vdc      | 85%         | AET00CC18-L  |
|                | <b>18-75 V</b>  | 2.5V @ 6A                               | 1.6" x 2" x 0.48" (40.6 x 50.8 x 12.19) | 1500 Vdc      | 79%         | AET06G36-L   |
|                | <b>18-75 V</b>  | 3.3V @ 6A                               | 1.6" x 2" x 0.48" (40.6 x 50.8 x 12.19) | 1500 Vdc      | 83%         | AET06F36-L   |
|                | <b>18-75 V</b>  | 5V @ 4A                                 | 1.6" x 2" x 0.48" (40.6 x 50.8 x 12.19) | 1500 Vdc      | 84%         | AET04A36-L   |
|                | <b>18-75 V</b>  | 12V @ 1.67A                             | 1.6" x 2" x 0.48" (40.6 x 50.8 x 12.19) | 1500 Vdc      | 85%         | AET01B36-L   |
|                | <b>18-75 V</b>  | 15V @ 1.33A                             | 1.6" x 2" x 0.48" (40.6 x 50.8 x 12.19) | 1500 Vdc      | 85%         | AET01C36-L   |
|                | <b>18-75 V</b>  | 5V @ ±2A                                | 1.6" x 2" x 0.48" (40.6 x 50.8 x 12.19) | 1500 Vdc      | 84%         | AET02AA36-L  |
|                | <b>18-75 V</b>  | 12V @ ±0.835A                           | 1.6" x 2" x 0.48" (40.6 x 50.8 x 12.19) | 1500 Vdc      | 85%         | AET00BB36-L  |
| <b>18-75 V</b> | 15V @ ±0.665A   | 1.6" x 2" x 0.48" (40.6 x 50.8 x 12.19) | 1500 Vdc                                | 85%           | AET00CC36-L |              |
| <b>30 W</b>    | <b>Enclosed</b> |   |   |               |             |              |
|                | <b>9-36 V</b>   | 2.5V @ 8A                               | 1.6" x 2" x 0.48" (40.6 x 50.8 x 12.19) | 1500 Vdc      | 79%         | AET08G18-L   |
|                | <b>9-36 V</b>   | 3.3V @ 7A                               | 1.6" x 2" x 0.48" (40.6 x 50.8 x 12.19) | 1500 Vdc      | 82%         | AET07F18-L   |
|                | <b>9-36 V</b>   | 5V @ 6A                                 | 1.6" x 2" x 0.48" (40.6 x 50.8 x 12.19) | 1500 Vdc      | 84%         | AET06A18-L   |
|                | <b>9-36 V</b>   | 12V @ 2.5A                              | 1.6" x 2" x 0.48" (40.6 x 50.8 x 12.19) | 1500 Vdc      | 85%         | AET02B18-L   |
|                | <b>9-36 V</b>   | 15V @ 2A                                | 1.6" x 2" x 0.48" (40.6 x 50.8 x 12.19) | 1500 Vdc      | 85%         | AET02C18-L   |
|                | <b>9-36 V</b>   | 12V @ ±1.25A                            | 1.6" x 2" x 0.48" (40.6 x 50.8 x 12.19) | 1500 Vdc      | 85%         | AET01BB18-L  |
|                | <b>9-36 V</b>   | 15V @ ±1A                               | 1.6" x 2" x 0.48" (40.6 x 50.8 x 12.19) | 1500 Vdc      | 85%         | AET01CC18-L  |
|                | <b>18-75 V</b>  | 2.5V @ 8A                               | 1.6" x 2" x 0.48" (40.6 x 50.8 x 12.19) | 1500 Vdc      | 79%         | AET08G36-L   |
|                | <b>18-75 V</b>  | 3.3V @ 7A                               | 1.6" x 2" x 0.48" (40.6 x 50.8 x 12.19) | 1500 Vdc      | 82%         | AET07F36-L   |
|                | <b>18-75 V</b>  | 5V @ 6A                                 | 1.6" x 2" x 0.48" (40.6 x 50.8 x 12.19) | 1500 Vdc      | 84%         | AET06A36-L   |
|                | <b>18-75 V</b>  | 12V @ 2.5A                              | 1.6" x 2" x 0.48" (40.6 x 50.8 x 12.19) | 1500 Vdc      | 85%         | AET02B36-L   |
|                | <b>18-75 V</b>  | 15V @ 2A                                | 1.6" x 2" x 0.48" (40.6 x 50.8 x 12.19) | 1500 Vdc      | 85%         | AET02C36-L   |
|                | <b>18-75 V</b>  | 12V @ ±1.25A                            | 1.6" x 2" x 0.48" (40.6 x 50.8 x 12.19) | 1500 Vdc      | 85%         | AET01BB36-L  |
|                | <b>18-75 V</b>  | 15V @ ±1A                               | 1.6" x 2" x 0.48" (40.6 x 50.8 x 12.19) | 1500 Vdc      | 85%         | AET01CC36-L  |



## Rapid Modification & Value-Added Solutions

### Why use a Modified Standard Power Supply?

Time-to-market, reliability and costs have the greatest impact on your ROI. Fully custom solutions can delay your time-to-market and undermine your competitive advantage. So why pay custom development costs when Emerson can deliver a modified standard power supply sample the way you want it, delivered in days at a standard price.

### Emerson has you Covered!

**No matter what type of power supply you need, Emerson has you covered!**

While Emerson Network Power offers a broad range of standard products that address the needs of many industries, there are occasions when a standard product does not address all your application requirements. Also, a custom solution does not always make economic sense, especially in terms of your schedule needs. This is where the knowledge and expertise of Emerson Network Power really pays dividends. By using proven standard platforms as building blocks, we can develop cost-effective turnkey power solutions that meet your exact needs.

- Sample lead time varies with complexity.

### Rapid Modification

*Simple to Complex Modifications  
Initial Samples Can be Available  
in Days!*

### Modified Advantage

**What you will get from Emerson's modified power supplies:**

- Broad portfolio of power supplies to leverage from
- Quick time to market vs. custom solutions
- Low risk - using proven reliable platforms as building blocks
- Cost effective (Lower development cost)
- Quality, high reliability products



### Value-Add & Changes Made

- Modified output termination from single to 3-way contact
- AC\_OK and POK Logic and timing signal changes via firmware
- Custom enclosure & accessories
- Ruggedization for shock & vibration
- Firmware changes for heavy peak loading startup; and load adaptive fan speed.



## Capabilities

*Exact specification you require,  
that's within your budget*



### Electrical Parameters

- Factory Vout Preset
- Low Noise
- Power & Efficiency Upgrades
- Hot Swap Control
- Inrush Current Control
- Integrated PDU Assemblies
- Compliance to Industry Standards



### Connectivity

- Cable Wire Assemblies
- Connector Changes
- Busbar Design
- Overmoulding
- Interposer Boards



### Packaging

- Conformal Coating
- Custom Chassis/Sled
- Ruggedization for: Shock & Vib; Hazardous Locations
- Shielding for High Magnetic Environment
- Sealed/IP Rated Enclosures
- Customized Print/Marking/Labels



### Communications & Control

- Logic Signal/Timing Changes
- Adaptive Fan Control
- Output Sequencing
- Peak Load/Efficiency Optimization

## Modified Solutions

Emerson provides modified standard products and value-add solutions in varying degrees of complexity. These meet specific customer needs in a wide range of applications, such as:



### Communications

- Access Solutions
- Enterprise Networking
- Wireless Communications
- Wireline Communications
- Optical Communications



### Healthcare

- Bio Life Sciences
- Dental
- Imaging
- Laboratory
- Medical



### Industrial

- Process Control
- Robotics
- Test & Measurement



### Lighting & Signage

- Displays
- Illuminated Signs



### Mil/Aero (COTS)

- Avionics
- In-flight Entertainment



## Terms and Conditions of Sale

The Emerson Network Power company that accepts Buyer's order for Goods is herein referred to as the "Seller" and the person or entity purchasing goods or services ("Goods") and/or licensing software and/or firmware which are preloaded, or to be loaded into Goods ("Software") from Seller is referred to as the "Buyer." These Terms and Conditions, any price list or schedule, quotation, acknowledgment or invoice from Seller relevant to the sale of the Goods and licensing of Software and all documents incorporated by specific reference herein or therein constitute the complete and exclusive statement of the terms governing the sale of Goods and license of Software by Seller to Buyer. Seller's acceptance of Buyer's purchase order is expressly conditional on Buyer's assent to all of Seller's terms and conditions of sale, including terms and conditions that are different from or additional to the terms and conditions of Buyer's purchase order. Buyer's acceptance of the Goods and/or Software will manifest Buyer's assent to these Terms and Conditions. Seller reserves the right in its sole discretion to refuse orders. Notwithstanding anything to the contrary, in the event that the provisions of these Terms and Conditions conflict with the provisions of an effective agreement signed by a duly authorized representative of both parties ("Effective Agreement") that applies to the transaction(s) contemplated herein, the Effective Agreement shall control.

**1. PRICES:** Unless otherwise specified in writing by Seller, the price quoted or specified by Seller for the Goods and/or Software shall remain in effect for 30 days after the date of Seller's quotation or acknowledgment of Buyer's order for the Goods and/or Software, whichever occurs first, provided an unconditional authorization from Buyer for the shipment of the Goods and/or Software is received and accepted by Seller within such time period. If such authorization is not received by Seller within such 30 day period, Seller shall have the right to change the price for the Goods and/or Software to Seller's price for the Goods and/or Software at the time of shipment. All prices and licensee fees are exclusive of taxes, transportation and insurance, which are to be borne by Buyer.

**2. TAXES:** Any current or future tax or governmental charge (or increase in same) affecting Seller's costs of production, sale, or shipment, or which Seller is otherwise required to pay or collect in connection with the sale, purchase, delivery, storage, processing, use or consumption of Goods, shall be for Buyer's account and shall be added to the price or billed to Buyer separately, at Seller's election.

**3. TERMS OF PAYMENT:** Unless otherwise specified by Seller, terms are net 30 days from date of Seller's invoice by bank wire transfer or automated clearing house in U.S. currency. Payment will be made no less frequent than weekly. Seller shall have the right, among other remedies, either to terminate this agreement or to suspend further performance under this and/or other agreements with Buyer in the event Buyer fails to make any payment when due, which other agreements Buyer and Seller hereby amend accordingly. Buyer shall be liable for all expenses, including attorneys' fees, relating to the collection of past due amounts. If any payment owed to Seller is not paid when due, it shall bear interest, at a rate to be determined by Seller, which shall not exceed the maximum rate permitted by law, from the date on which it is due until it is paid. Any payment due to either party under this agreement shall be made in full without any set-off, restriction, condition deduction or withholding for or on account of any counterclaim. Should Buyer's financial responsibility become unsatisfactory to Seller, cash payments or security satisfactory to Seller may be required by Seller for future deliveries of the Goods and/or Software. If such cash payment or security is not provided, in addition to Seller's other rights and remedies, Seller may discontinue deliveries.

**4. SHIPMENT AND DELIVERY:** While Seller will use all reasonable commercial efforts to maintain the delivery date(s) acknowledged or quoted by Seller, all shipping dates are approximate and not guaranteed. Seller reserves the right to make partial shipments. Seller, at its option, shall not be bound to tender delivery of any Goods and/or Software for which Buyer has not provided shipping instructions and other required information. If the shipment of the Goods and/or Software is postponed or delayed by Buyer for any reason, Buyer agrees to reimburse Seller for any and all storage costs and other additional expenses resulting therefrom. Risk of loss and legal title to the Goods shall transfer from Seller to Buyer upon delivery to and receipt by carrier at Seller's shipping point. Unless otherwise specified by Seller, all shipments are F.C.A. Seller's shipping point (Incoterms 2010). Any claims for shortages or damages suffered in transit are the responsibility of Buyer and shall be submitted by Buyer directly to the carrier. Shortages or damages must be identified and signed for at the time of delivery.

Buyer shall inspect Goods delivered to it by Seller immediately upon receipt, and, any course of dealing to the contrary notwithstanding, failure of Buyer to give Seller notice of any claim within 10 days after receipt of such Goods shall be an unqualified acceptance of such Goods.

**5. LIMITED WARRANTY:** Subject to the limitations of Section 6 and unless otherwise specified by Seller in writing, Seller warrants that the Goods manufactured by Seller will be free from defects in material and workmanship and substantially meet Seller's published specifications at the time of shipment under normal use and regular service and maintenance for (a) the period specified in Seller's then current product data sheets from the date of manufacture by Seller for standard Embedded Power Goods, (b) 2 years from initial shipment for standard Embedded Computing Goods, and (c) the period specified by Seller in writing for custom Embedded Power Goods and custom Embedded Computing Goods. Unless otherwise stated

in a separate Software license agreement, Seller makes no warranty as to any Software. **THE WARRANTIES SET FORTH IN SECTIONS 5 AND 7 ARE THE SOLE AND EXCLUSIVE WARRANTIES GIVEN BY SELLER WITH RESPECT TO THE GOODS AND SOFTWARE AND ARE IN LIEU OF AND EXCLUDE ALL OTHER WARRANTIES, EXPRESS OR IMPLIED, ARISING BY OPERATION OF LAW OR OTHERWISE, INCLUDING WITHOUT LIMITATION, MERCHANTABILITY AND FITNESS FOR A PARTICULAR PURPOSE WHETHER OR NOT THE PURPOSE OR USE HAS BEEN DISCLOSED TO SELLER IN SPECIFICATIONS, DRAWINGS OR OTHERWISE, AND WHETHER OR NOT SELLER'S PRODUCTS ARE SPECIFICALLY DESIGNED AND/OR MANUFACTURED BY SELLER FOR BUYER'S USE OR PURPOSE.**

These warranties do not extend to any losses or damages due to misuse, accident, abuse, neglect, negligence (other than Seller's), unauthorized modification or alteration, use beyond rated capacity, unsuitable power sources or environmental conditions, improper installation, repair, handling, maintenance or application or any other cause not the fault of Seller. To the extent that Buyer or its agents have supplied specifications, information, representation of operating conditions or other data to Seller in the selection or design of the Goods and the preparation of Seller's quotation, and in the event that actual operating conditions or other conditions differ from those represented by Buyer, any warranties or other provisions contained herein that are affected by such conditions shall be null and void.

If within 30 days after Buyer's discovery of any warranty defects within the warranty period, Buyer notifies Seller thereof in writing, Seller shall, at its option and as Buyer's exclusive remedy, repair, correct or replace per its return policy, or refund the purchase price for, that portion of the Goods found by Seller to be defective. Failure by Buyer to give such written notice within the applicable time period shall be deemed an absolute and unconditional waiver of Buyer's claim for such defects. Advance written permission to return Goods must be obtained from Seller. Such Goods must be shipped transportation prepaid to Seller. Returns made without proper written permission will not be accepted by Seller. Seller reserves the right to inspect Goods prior to authorizing return. Goods repaired or replaced during the warranty period shall be covered by the foregoing warranties for the remainder of the original warranty period or 90 days from the date of shipment, whichever is longer.

Buyer assumes all other responsibility for any loss, damage, or injury to persons or property arising out of, connected with, or resulting from the use of Goods and/or Software, either alone or in combination with other products/components.

**PRE-PRODUCTION (Prototype, Engineering Verification Test, or Design Verification Test) UNITS ARE SOLD "WHERE IS, AS IS, WITH ALL FAULTS" WITHOUT WARRANTY OF ANY KIND, EXPRESS OR IMPLIED, INCLUDING, WITHOUT LIMITATION, IMPLIED WARRANTIES OF MERCHANTABILITY OR FITNESS FOR INTENDED PURPOSE.**

**6. LIMITATION OF REMEDY AND LIABILITY: THE SOLE AND EXCLUSIVE REMEDY FOR BREACH OF ANY WARRANTY HEREUNDER (OTHER THAN THE WARRANTY PROVIDED UNDER SECTION 7) SHALL BE LIMITED TO REPAIR, CORRECTION OR REPLACEMENT, OR REFUND OF THE PURCHASE PRICE UNDER SECTION 5.**

**SELLER SHALL NOT BE LIABLE FOR DAMAGES CAUSED BY DELAY IN PERFORMANCE AND THE REMEDIES OF BUYER SET FORTH IN THIS AGREEMENT ARE EXCLUSIVE. IN NO EVENT, REGARDLESS OF THE FORM OF THE CLAIM OR CAUSE OF ACTION (WHETHER BASED IN CONTRACT, INFRINGEMENT, NEGLIGENCE, STRICT LIABILITY, OTHER TORT OR OTHERWISE), SHALL SELLER'S LIABILITY TO BUYER AND/OR ITS CUSTOMERS EXCEED THE PRICE PAID BY BUYER FOR THE SPECIFIC GOODS OR SOFTWARE PROVIDED BY SELLER GIVING RISE TO THE CLAIM OR CAUSE OF ACTION. BUYER AGREES THAT IN NO EVENT SHALL SELLER'S LIABILITY TO BUYER AND/OR ITS CUSTOMERS EXTEND TO INCLUDE INCIDENTAL, CONSEQUENTIAL OR PUNITIVE DAMAGES.** The term "consequential damages" shall include, but not be limited to, loss of anticipated profits, business interruption, loss of use, revenue, reputation and data, costs incurred, including without limitation, for capital, fuel, power and loss or damage to property or equipment.

It is expressly understood that any technical advice furnished by Seller with respect to the use of the Goods and/or Software is given without charge, and Seller assumes no obligation or liability for the advice given, or results obtained, all such advice being given and accepted at Buyer's risk.

**7. PATENTS AND COPYRIGHTS:** Subject to the limitations of the second paragraph of Section 6, Seller warrants that the Goods sold, except as are made specifically for Buyer according to Buyer's specifications, do not infringe any valid U.S. patent or copyright in existence as of the date of shipment. This warranty is given upon the condition that Buyer promptly notifies Seller of any claim or suit involving Buyer in which such infringement is alleged and cooperates fully with Seller and permits Seller to control completely the defense, settlement or compromise of any such allegation of infringement. Seller's warranty as to utility patents only applies to infringement arising solely out of the inherent operation according to Seller's specifications and instructions of such Goods. In the event such Goods are held to infringe such a U.S. patent or copyright in such suit, and / or the use of such Goods is enjoined, or in

# Terms and Conditions

the case of a compromise or settlement by Seller, Seller shall have the right, at its option and expense, to procure for Buyer the right to continue using such Goods, or replace them with non-infringing Goods, or modify same to become non-infringing, or grant Buyer a credit for the depreciated value of such Goods and accept return of them. In the event of the foregoing or, if in Seller's opinion, Seller receives a credible allegation of infringement, Seller may also, at its option, cancel or suspend this agreement as to future deliveries of such Goods, without liability.

**8. EXCUSE OF PERFORMANCE:** Seller shall not be liable for delays in performance or for non-performance due to acts of God; acts of Buyer; war; fire; flood; weather; sabotage; epidemics; strikes or labor disputes; civil disturbances or riots; governmental requests, restrictions, allocations, laws, regulations, orders or actions; unavailability of or delays in transportation; default of suppliers; or unforeseen circumstances or any events or causes beyond Seller's reasonable control. Deliveries or other performance may be suspended for an appropriate period of time or canceled by Seller upon notice to Buyer in the event of any of the foregoing, but the balance of the agreement shall otherwise remain unaffected as a result of the foregoing.

If Seller determines that its ability to supply the total demand for the Goods, or to obtain material used directly or indirectly in the manufacture of the Goods, is hindered, limited or made impracticable due to causes set forth in the preceding paragraph, Seller may allocate its available supply of the Goods or such material (without obligation to acquire other supplies of any such Goods or material) among its purchasers on such basis as Seller determines to be equitable without liability for any failure of performance which may result therefrom.

**9. RESCHEDULE/CANCELLATION:** Unless otherwise agreed in writing by Seller, orders under this agreement may not be rescheduled or canceled by Buyer for any reason.

**10. CHANGES:** Buyer may request changes or additions to the Goods and/or Software consistent with Seller's specifications and criteria. In the event such changes or additions are accepted by Seller, Seller may revise the price, license fees and dates of delivery.

Seller reserves the right to change designs and specifications for the Goods and/or Software without prior notice to Buyer, except with respect to Goods and/or Software being made to order for Buyer. Seller shall have no obligation to install or make such change in any Goods and/or Software manufactured prior to the date of such change.

**11. NUCLEAR/MEDICAL: GOODS AND SOFTWARE SOLD HEREUNDER ARE NOT FOR USE IN CONNECTION WITH ANY NUCLEAR, MEDICAL, LIFE-SUPPORT AND OTHER HIGH RISK APPLICATIONS WHERE GOODS OR SOFTWARE FAILURE COULD LEAD TO LOSS OF LIFE OR CATASTROPHIC PROPERTY DAMAGE.** Buyer accepts Goods and Software with the foregoing understanding, agrees to communicate the same in writing to any subsequent purchasers or users and to defend, indemnify and hold harmless Seller from any claims, losses, suits, judgments and damages, including incidental and consequential damages, arising from such use, whether the cause of action be based in tort, contract or otherwise, including allegations that the Seller's liability is based on negligence or strict liability.

**12. ASSIGNMENT:** Buyer shall not assign its rights or delegate its duties hereunder or any interest herein without the prior written consent of Seller, and any such assignment, without such consent, shall be void.

**13. SOFTWARE:** Notwithstanding any other provision herein to the contrary, Seller or applicable third party licensor to Seller shall retain all rights of ownership and title in its respective Software, including without limitation all rights of ownership and title in its respective copies of such Software. Except as otherwise provided herein, Buyer is hereby granted a nonexclusive, non-transferable royalty free license to use the Software incorporated into the Goods solely for purposes of Buyer properly utilizing such Goods purchased from Seller. All other Software shall be furnished to, and used by, Buyer only after execution of Seller's (or the licensor's) applicable standard license agreement, the terms of which are incorporated herein by reference. The Software is Seller's own or Seller's supplier's proprietary information, and Buyer and its employees and agents shall not disclose the Software to others without Seller's prior written consent.

**14. TOOLING:** Tool, die, and pattern charges, if any, are in addition to the price of the Goods and are due and payable upon completion of the tooling. All such tools, dies and patterns shall be and remain the property of Seller. Charges for tools, dies, and patterns do not convey to Buyer, title, ownership interest in, or rights to possession or removal, or prevent their use by Seller for other purchasers, except as otherwise expressly provided by Seller and Buyer in writing with reference to this provision.

**15. INTELLECTUAL PROPERTY:** Seller's intellectual property, including without limitation, all patents, copyrights, trade secrets, trade-dress and any other intellectual property of any kind (including without limitation, that which exists in the underlying technology), furnished by Seller to Buyer in connection with this agreement is the property of Seller and Seller retains all rights, including without limitation, exclusive rights of use, licensing, and sale. Possession of Goods, pre-production units, specifications, prints or drawings, or any other materials does not convey to Buyer any rights or license thereto.

**16. BUYER'S COMPLIANCE WITH LAWS:** In connection with the transactions contemplated by this agreement, Buyer is familiar with and shall fully comply with all applicable laws, regulations, rules and other requirements of the United States and of any applicable state, foreign and local governmental body in connection with the purchase, license, receipt, use, transfer and disposal of the Goods and/or Software.

**17. EXPORT/IMPORT:** Buyer agrees that all applicable import and export control laws, regulations, orders and requirements, including without limitation those of the United States and the European Union, and the jurisdictions in which the Seller and Buyer are established or from which Goods and/or Software may be supplied, will apply to their receipt and use. In no event shall Buyer use, transfer, release, import, export, Goods and/or Software in violation of such applicable laws, regulations, orders or requirements.

**18. GOVERNMENT CONTRACT CONDITIONS:** In the event Buyer supplies Goods or Software to the U.S. Government or to a prime contractor selling to the U.S. Government, the following Federal Acquisition Regulation (FAR) clauses are accepted by Seller and are made part of this agreement applicable to such supply: 52.222-21 Prohibition of Segregated Facilities; 52.222-26 Equal Opportunity; 52.222-35 Equal Opportunity For Special Disabled Veterans, Veterans of Vietnam Era, and Other Eligible Veterans; 52.222-36 Affirmative Action For Workers with Disabilities; and 52.219-8 Utilization of Small Business Concerns. No additional FAR or FAR Supplement clauses are accepted by Seller. In the event Buyer elects to sell Goods or Software to the U.S. Government or any national, state, provincial or local non-U.S. governmental entity or to a prime contractor selling to such entities, Buyer does so solely at its own option and risk, and agrees not to obligate Seller as a subcontractor or otherwise to the U.S. Government or other governmental entity except as described in this Section 18. Buyer remains solely and exclusively responsible for compliance with all statutes and regulations governing sales to the U.S. Government or any national, state, provincial or local non-U.S. governmental entity. Seller makes no representations, certifications or warranties whatsoever with respect to the ability of its Goods, Software, or prices to satisfy any such statutes and regulations.

**19. GENERAL PROVISIONS:** These terms and conditions supersede all other communications, negotiations and prior oral or written statements regarding the subject matter of these terms and conditions. No change, modification, rescission, discharge, abandonment, or waiver of these terms and conditions shall be binding upon the Seller unless made in writing and signed on its behalf by a duly authorized representative of Seller. No conditions, usage of trade, course of dealing or performance, understanding or agreement purporting to modify, vary, explain, or supplement these terms and conditions shall be binding unless hereafter made in writing and signed by the party to be bound, and no modification or additional terms shall be applicable to this agreement by Seller's receipt, acknowledgment, or acceptance of purchase orders, shipping instruction forms, or other documentation containing terms at variance with or in addition to those set forth herein. Any such modifications or additional terms are specifically rejected and deemed a material alteration hereof. If this document shall be deemed an acceptance of a prior offer by Buyer, such acceptance is expressly conditional upon Buyer's assent to any additional or different terms set forth herein. No waiver by either party with respect to any breach or default or of any right or remedy, and no course of dealing, shall be deemed to constitute a continuing waiver of any other breach or default or of any other right or remedy, unless such waiver be expressed in writing and signed by the party to be bound. All typographical or clerical errors made by Seller in any quotation, acknowledgment or publication are subject to correction. In the event that any provision or portion thereof contained in the Contract is held to be unenforceable, the Contract shall be construed without such provision or portion thereof.

(A) If Seller is a U.S. incorporated entity: This Agreement shall be governed by the laws of the State of Delaware, U.S.A., without reference to its choice or conflict of laws principles. The parties agree to submit to the exclusive jurisdiction of the courts of the State of Delaware for all actions arising in connection herewith.

(B) If Seller is a European incorporated entity: This Agreement shall be governed by the laws of England. Any dispute arising out of or in connection with this Agreement that cannot be resolved through friendly consultation shall be referred to and finally resolved by arbitration in London, England before the London Court of International Arbitration in accordance with its arbitration rules. The arbitral award shall be final and binding on the parties.

(C) If Seller is an entity incorporated in the Asia Pacific region: This Agreement shall be governed by the laws of the Hong Kong Special Administrative Region of the People's Republic of China. Any dispute arising out of or in connection with this Agreement that cannot be resolved through friendly consultation shall be referred to and finally resolved by arbitration in Hong Kong before the Hong Kong International Arbitration Centre in accordance with its arbitration rules. The arbitral award shall be final and binding on the parties.

(D) No action, regardless of form, arising out of transactions relating to this agreement, may be brought by either party more than two (2) years after the cause of action has accrued. The U.N. Convention on Contracts for the International Sales of Goods shall not apply to this agreement.

Revised March 13, 2012

## Technology Index

| Section                   | Page               | Section                           | Page                   | Section                               | Page           |
|---------------------------|--------------------|-----------------------------------|------------------------|---------------------------------------|----------------|
| <b>Low Power</b>          |                    | <b>Medium Power</b>               |                        | <b>Industry Standard Non-Isolated</b> |                |
| LCC                       | 15, 16             | MP                                | 27, 28                 | APA                                   | 63             |
| LCT                       | 10                 |                                   |                        | APC                                   | 63             |
| LPQ                       | 13, 14             | <b>Intelligent Medium Power</b>   |                        | LDO                                   | 62             |
| LPS                       | 10, 11, 12, 13, 14 | iMP                               | 29, 30, 31             | LGA                                   | 62             |
| LPT                       | 10, 11, 12, 13     | <b>Intelligent High Power</b>     |                        | PTH                                   | 65             |
| NLP                       | 10, 12, 14         | iVS                               | 32, 33, 34             | PTV                                   | 65             |
| NPS                       | 10, 11             | <b>Bulk Power</b>                 |                        | SIL                                   | 61, 62, 63     |
| NTS                       | 14                 | HPR                               | 42                     | SMT                                   | 61, 62, 63, 64 |
| TLP                       | 13                 | HPS                               | 41, 42                 | VRM                                   | 66             |
| <b>External Power</b>     |                    | LCM                               | 35, 36, 37, 38, 39, 40 | <b>High Power</b>                     |                |
| AD                        | 18, 19             | UFE                               | 41, 42, 43             | AIF                                   | 68             |
| DA                        | 18                 | <b>Distributed Power</b>          |                        | AIH                                   | 68             |
| DCH                       | 17                 | DS                                | 44, 45, 46, 47, 48, 49 | AIQ                                   | 68             |
| DP                        | 19                 | <b>Din Rail</b>                   |                        | AIT                                   | 68             |
| DPS                       | 19                 | ADN                               | 50, 51                 | PSE1000                               | 68             |
| <b>Medical Power</b>      |                    | <b>Industry Standard Isolated</b> |                        | <b>Low Power DC-DC Product</b>        |                |
| DA                        | 23                 | AEO                               | 56                     | AEE                                   | 69             |
| DPS                       | 23                 | AEQ                               | 58                     | AET                                   | 70             |
| iMP                       | 23                 | AGH                               | 59                     | ASA                                   | 69             |
| iVS                       | 23                 | AGQ                               | 57, 58                 |                                       |                |
| LCC                       | 22                 | ALD                               | 54                     |                                       |                |
| LCM                       | 22                 | ALO                               | 55                     |                                       |                |
| LPQ                       | 22                 | ALQ                               | 58                     |                                       |                |
| LPS                       | 20, 21, 22         | AVE                               | 59, 60                 |                                       |                |
| LPT                       | 20, 21             | AVQ                               | 58                     |                                       |                |
| NLP                       | 21, 22             | BXB                               | 59                     |                                       |                |
| NPS                       | 20, 21             | EXB                               | 59, 60                 |                                       |                |
| NTS                       | 22                 | LES                               | 55, 56                 |                                       |                |
| TLP                       | 21                 | LQS                               | 57, 58                 |                                       |                |
| μMP                       | 22                 | RFB                               | 60                     |                                       |                |
| <b>LED Drivers</b>        |                    |                                   |                        |                                       |                |
| LDS                       | 24                 |                                   |                        |                                       |                |
| <b>Micro Medium Power</b> |                    |                                   |                        |                                       |                |
| μMP                       | 25, 26             |                                   |                        |                                       |                |



Zwingenstrasse 6-8, A-2380 Perchtoldsdorf  
 Tel. Vienna +43/(0)1/86 305 - 5000  
 Fax Vienna +43/(0)1/86 305 - 98  
 e-mail: office@codico.com  
 www.codico.com

## Ecosystem Leadership

Just as nature relies on communities of organisms functioning as an ecological unit, embedded power solutions depend on a broad and powerful ecosystem, including standards bodies, industry associations, technology alliances and engineering communities. Emerson Network Power brings a wealth of innovation and many years experience to accredited standards development organizations, specification consortia and industry associations through our executive memberships and key committee positions. We have long been committed to a strong ecosystem that works to further the development of the industries and technologies that are important to our customers' success.



Emerson, Emerson. Consider It Solved, Business-Critical Continuity and Emerson Network Power are trademarks of Emerson Electric Co. or one of its affiliated companies. PICMG, AdvancedTCA, ATCA, MicroTCA, and the AdvancedTCA and MicroTCA logos are trademarks of the PCI Industrial Computer Manufacturers Group. Intel is a trademark or registered trademark of Intel Corporation or its subsidiaries in the US and other countries. PMBus and the PMBus logo are trademarks of System Management Interface Forum, Inc. POLA logo and Auto-Track are trademarks of Texas Instruments Incorporated. The word mark "The Green Grid" and The Green Grid design mark or logo are service marks of The Green Grid Association. All other trademarks are the property of their respective owners. ©2011 Emerson Electric Co.

## Emerson Network Power.

The global leader in enabling *Business Critical Continuity*™.

- |              |  |                            |                             |
|--------------|--|----------------------------|-----------------------------|
| AC Power     | Embedded Computing                     | Outside Plant              | Racks & Integrated Cabinets |
| Connectivity | <b>Embedded Power</b>                  | Power Switching & Controls | Services                    |
| DC Power     | Infrastructure Management & Monitoring | Precision Cooling          | Surge Protection            |

## Americas

5810 Van Allen Way  
 Carlsbad, CA 92008  
 USA  
 Telephone: +1 760 930 4600  
 Facsimile: +1 760 930 0698

## Europe (UK)

Waterfront Business Park  
 Merry Hill, Dudley  
 West Midlands, DY5 1LX  
 United Kingdom  
 Telephone: +44 (0) 1384 842 211  
 Facsimile: +44 (0) 1384 843 355

## Asia (HK)

14/F, Lu Plaza  
 2 Wing Yip Street  
 Kwun Tong, Kowloon  
 Hong Kong  
 Telephone: +852 2176 3333  
 Facsimile: +852 2176 3888

For global contact, visit:

[Emerson.com/EmbeddedPower](http://Emerson.com/EmbeddedPower)

[TechSupport.EmbeddedPower@Emerson.com](mailto:TechSupport.EmbeddedPower@Emerson.com)

While every precaution has been taken to ensure accuracy and completeness in this literature, Emerson Network Power assumes no responsibility, and disclaims all liability for damages resulting from use of this information or for any errors or omissions.

Issue AP1 March 2013

[EmersonNetworkPower.com](http://EmersonNetworkPower.com)