

# MAGIC LED

## PLW138003 Series

### Advanced Product Information



#### Description

Plessey MAGIC PLW138003 ultra-thin SMT LEDs are designed for symbol backlight applications. The light is emitted in wide emission angles and hence this SMT package is suitable for indicators in mobile devices. The LEDs are packed in reels containing 8000 pieces; every reel will be shipped in single intensity and colour bin, to provide close uniformity.

#### Features

- Ultra-thin 1005 footprint
- High reliability PLCC packaging
- Diffused pale yellow resin
- 130 degree wide viewing angle
- GaN-on-Si die technology

#### Applications

- Decoration Lighting
- Instrument panel backlighting
- Illumination symbols
- Miniature dot-matrix displays
- Wearable devices

Variant	Nominal Colour (x, y)	Luminous Intensity I <sub>v</sub> (mcd)	
		Min.	Max.
PLW138003-A	(0.280, 0.260)	100	190
PLW138003-B	(0.300, 0.290)		
PLW138003-C	(0.275, 0.240)		

## Absolute Maximum Ratings

T<sub>amb</sub> = +25°C unless otherwise stated

Parameter	Symbol	Minimum	Maximum	Unit
DC Forward Current	I <sub>F</sub>	-	10	mA
Peak Pulse Forward Current <sup>[1]</sup>	I <sub>FP</sub>	-	50	mA
Reverse Voltage	V <sub>R</sub>	-	5	V
Storage Temperature	T <sub>stg</sub>	-40	+100	°C
Junction Temperature	T <sub>j</sub>	-	+120	°C

[1] Pulse width ≤10ms, duty cycle ≤10%

## Electro-optical Characteristics

T<sub>amb</sub> = +25°C unless otherwise stated

Parameter	Symbol	Condition	Min.	Typ.	Max.	Unit
Forward Voltage	V <sub>F</sub>	I <sub>F</sub> = 5mA	2.75	2.90	3.50	V
Reverse Current	I <sub>R</sub>	V <sub>R</sub> = 5V	-	-	100	μA
Chromaticity co-ordinates	x	I <sub>F</sub> = 5mA	-	0.282	-	
	y		-	0.260	-	
Thermal Resistance	R <sub>thj-sp</sub>		-	tbd	-	K/W
Half-Intensity Angle	2Θ <sub>1/2</sub>	I <sub>F</sub> = 5mA	-	130	-	deg

## Recommended Operating Conditions

In typical applications, for optimum LED performance

Parameter	Symbol	Minimum	Maximum	Unit
Operating Ambient Temperature	T <sub>opr</sub>	-40	+85	°C

## Ordering Information

Order code	Colour range	Luminous intensity range	Forward voltage
PLW138003000	A, B & C	1L & 2L	V1 & V2
PLW138003001	A & B	1L & 2L	V1
PLW138003002	A & B	1L & 2L	V1 & V2
PLW138003003	A & C	1L & 2L	V1 & V2

## Intensity Bin Groups

$I_F = 5\text{mA}$ ,  $T_{\text{amb}} = +25^\circ\text{C}$ , unless otherwise stated

Group	Luminous intensity <sup>[1]</sup> (mcd)	
	Min.	Max.
1L	100	150
2L	150	190

<sup>[1]</sup> Tolerance  $\pm 11\%$

## Forward Voltage Bin Groups

$I_F = 5\text{mA}$ ,  $T_{\text{amb}} = +25^\circ\text{C}$ , unless otherwise stated

Group	$V_F$ <sup>[1]</sup> (V)	
	Min.	Max.
V1	2.75	3.30
V2	3.30	3.50

<sup>[1]</sup> Tolerance  $\pm 0.05\text{V}$

### Relative Spectral Emission (Typical)

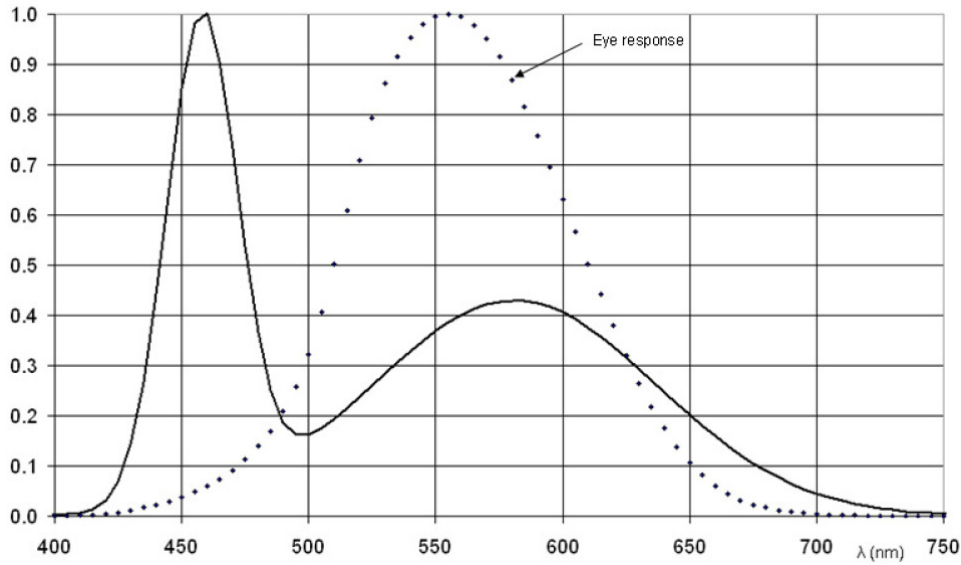

Figure 1. Normalised spectral power distribution

### Angular Light Distribution

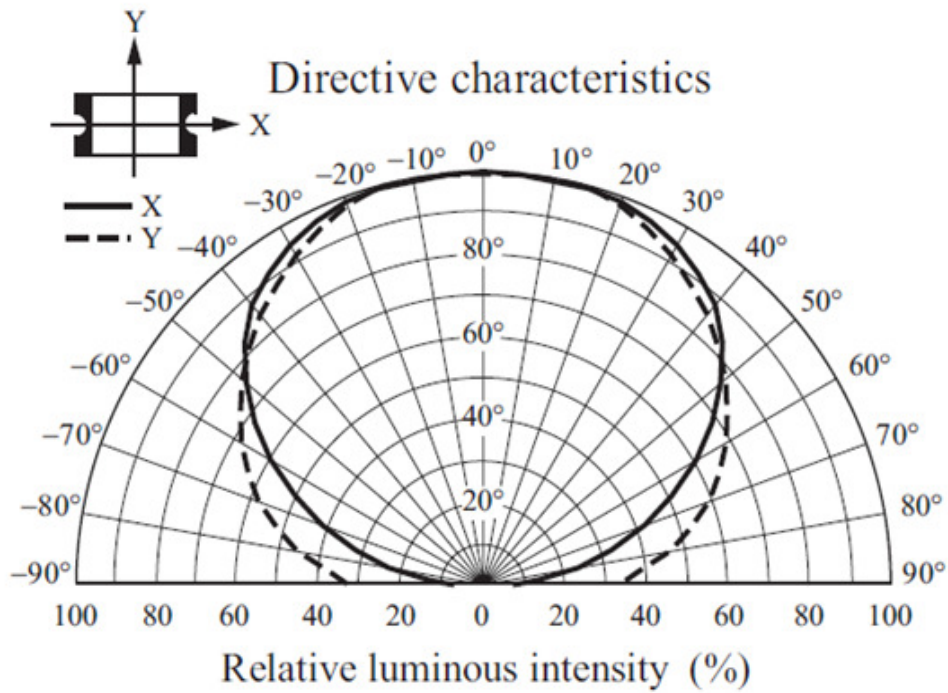

Figure 2. Angular distribution pattern of emitted light

### Colour Chromaticity

A		B		C	
x	y	x	y	x	y
0.28	0.248	0.287	0.295	0.28	0.248
0.296	0.276	0.307	0.315	0.265	0.215
0.287	0.295	0.311	0.294	0.255	0.225
0.264	0.267	0.296	0.276	0.272	0.257

Chromaticity co-ordinate tolerance for each bin is  $\pm 0.01$

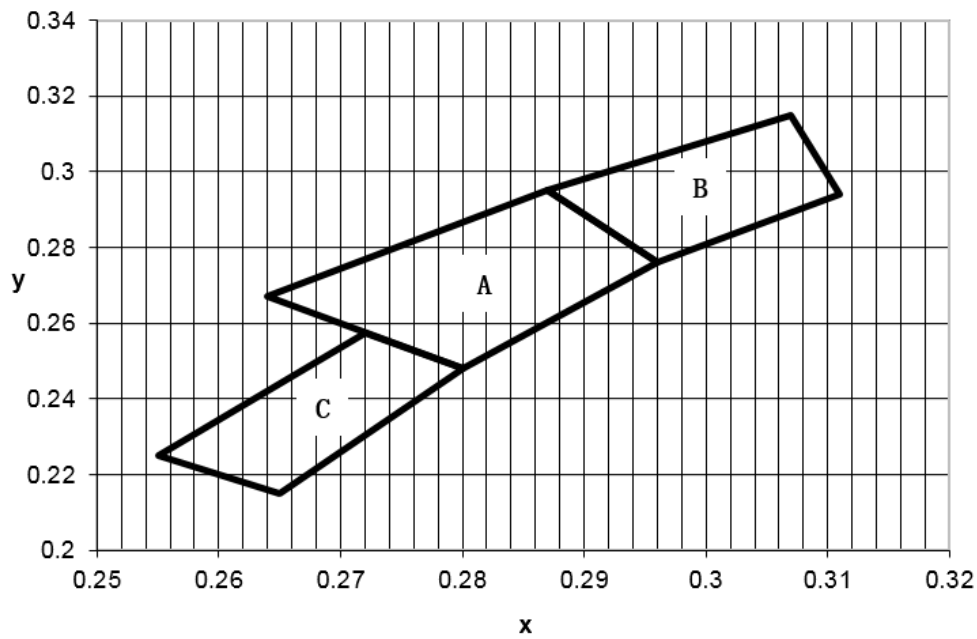

Figure 3. CIE1931 chromaticity diagram

## Package Outline Dimensions

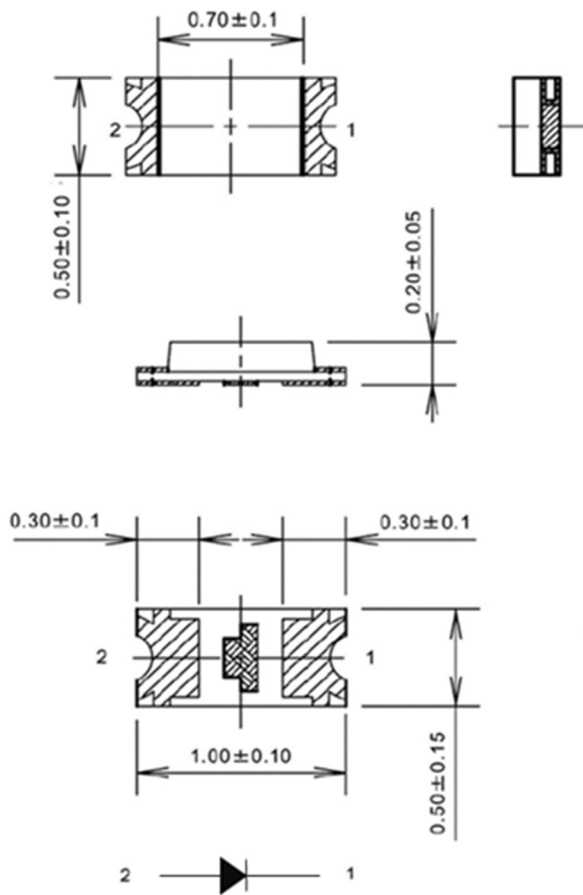

Figure 4. Mechanical drawings of the 1005 package (unit in mm)

## Recommended Solder Pad

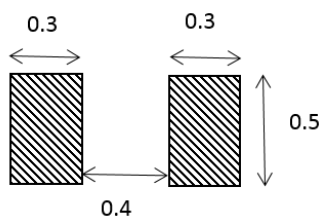

Figure 5. Diagram of soldering pad (unit in mm)

Note: Increased PCB Cu area will reduce the  $T_j$  and increase reliability

## Reflow Soldering Profile

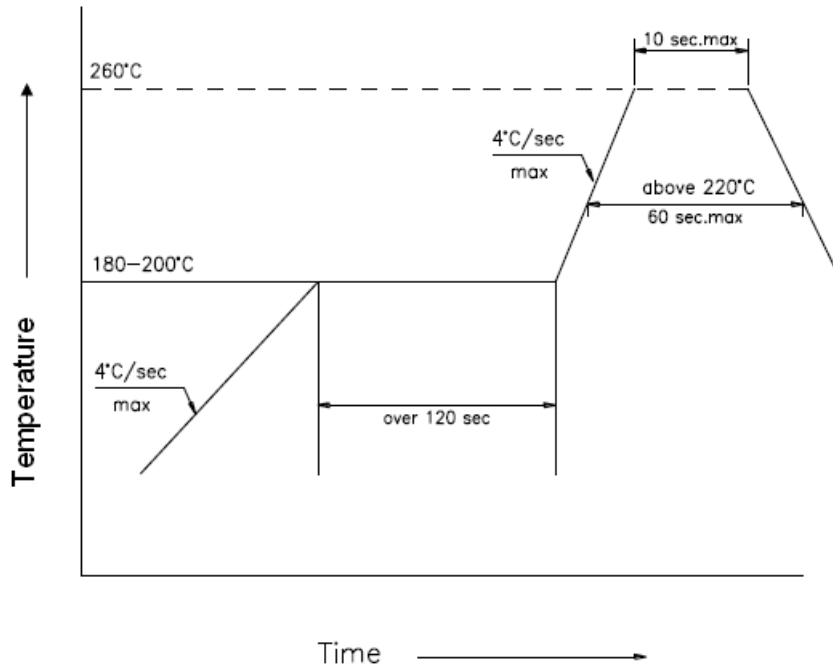

Figure 6. Reflow soldering profile

1. Reflow soldering should not be done more than twice
2. When soldering, do not put stress on the LEDs during heating

### Soldering iron

1. When hand soldering, the temperature of the iron must be  $\leq 300^{\circ}\text{C}$  for 3 seconds
2. Hand soldering should be performed only once.

## Handling Instructions

Plessey LEDs are not designed to operate with reverse bias.

Precautions are required to prevent reverse bias in applications and during handling.

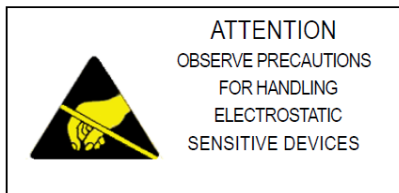

## Moisture Sensitivity

JEDEC Level	Floor life		Bake	
	Time	Conditions	Time	Conditions
4	72 hours	$\leq 30^{\circ}\text{C} / 60\% \text{ RH}$	$\geq 24$ hours	$125^{\circ}\text{C} \pm 5^{\circ}\text{C}$

## Packing Information

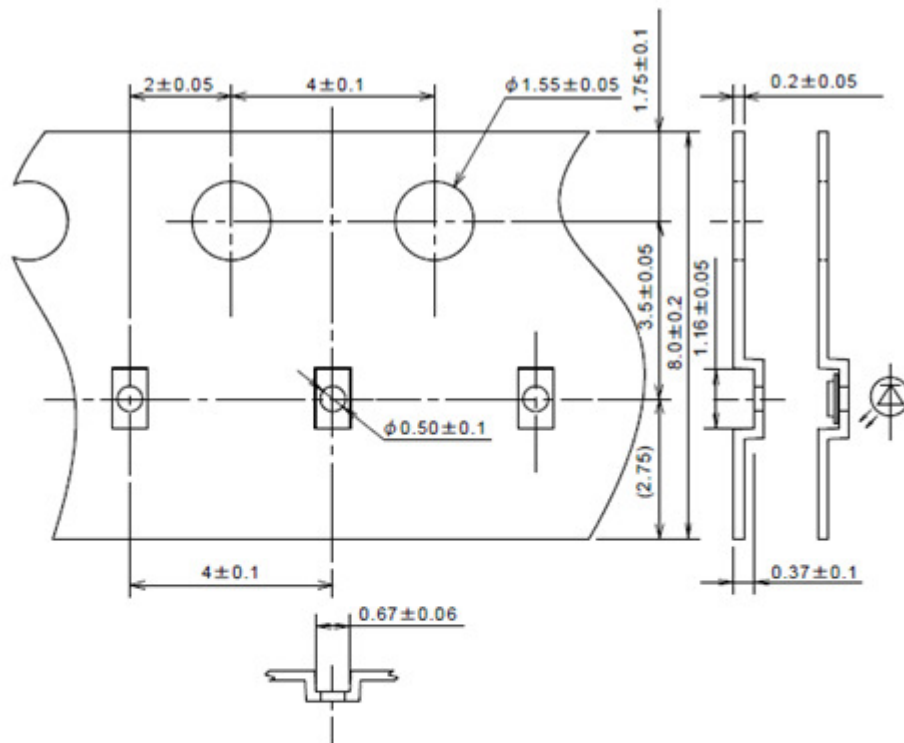

(Note1) Unless specified R of the corner is Max. 0.3 mm.

(Note2) Allowance of accumulated pitch of feeding holes is  $\pm 0.4$  mm per 50 pitches.

Figure 7. Embossed tapping specifications (unit in mm)



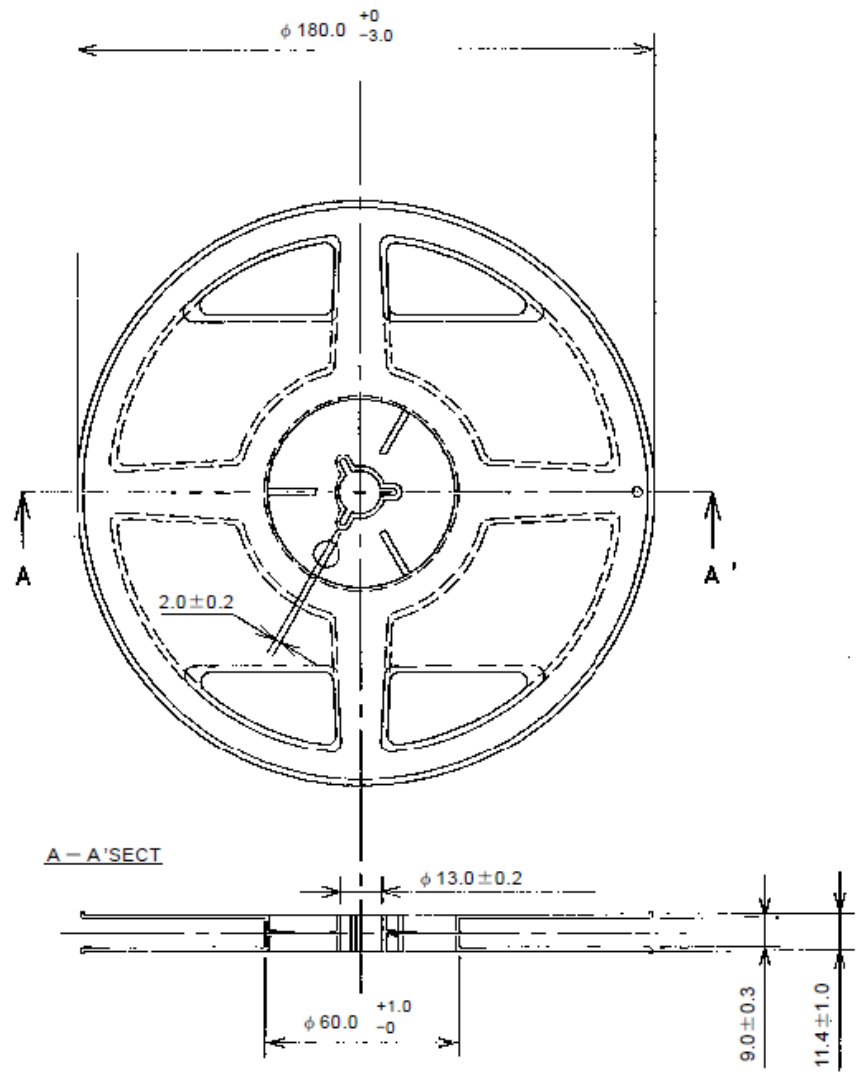

(Note1) This part is the application of JEITA ETX-7001.

Figure 8. Reel specification (unit in mm)

■ Taping specifications

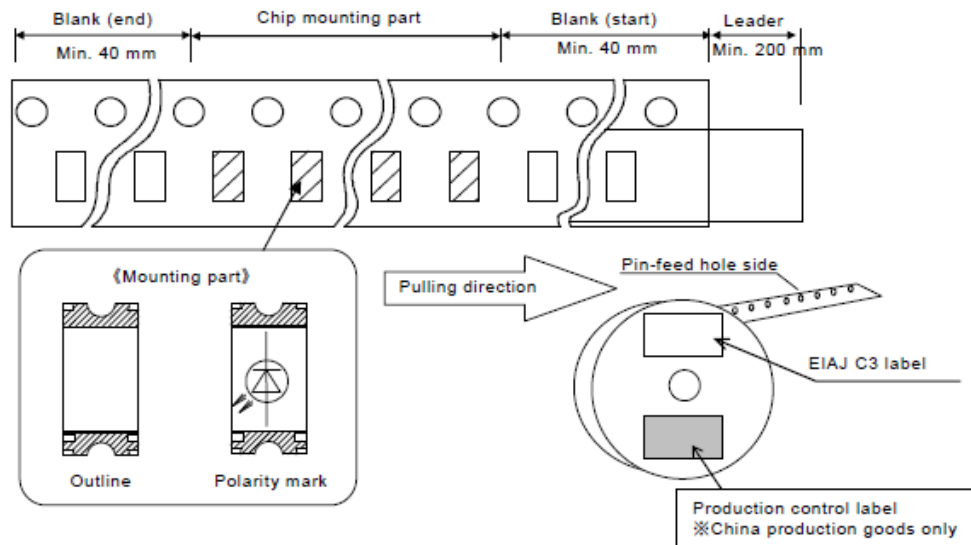

1. Pin-feed holes should be on the left side on the tape in the pulling direction.
2. Chip LED taping direction.  
The right side on the tape in the pulling direction is anode.
3. The leader part is saved as cover tape, which should be 200 mm or longer.
4. Keep more than 10 emboss blanks both at front and end of the taping.

■ Mechanical strength and treatment

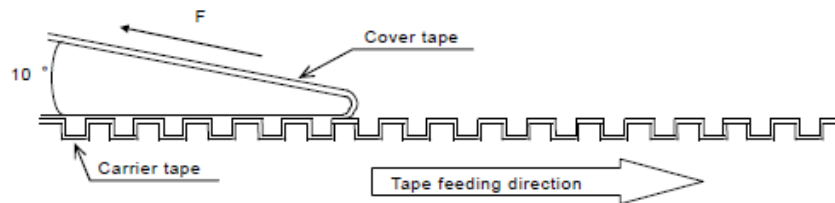

1. Exfoliation strength of the cover tape should be 0.19 N ~ 0.69 N.
2. Tape bending strength  
Tape should not be deformed by bending with a radius of 15 mm.
3. Percentage defective of enclosed  
The product which was enclosed in reverse direction or with back side up should be counted as 0 piece/reel.  
The number of dropped parts should be 0.1 % of entire number of parts or 1 piece, whichever larger.  
There should be no continuous dropping however total number has to remain intact.
4. There should be no tape joint.

## Legal Notice

Product information provided by Plessey Semiconductors Limited (“Plessey”) in this document is believed to be correct and accurate. Plessey reserves the right to change/correct the specifications and other data or information relating to products without notice but Plessey accepts no liability for errors that may appear in this document, howsoever occurring, or liability arising from the use or application of any information or data provided herein. Neither the supply of such information, nor the purchase or use of products conveys any licence or permission under patent, copyright, trademark or other intellectual property right of Plessey or third parties.

Products sold by Plessey are subject to its standard Terms and Conditions of Sale that are available on request. No warranty is given that products do not infringe the intellectual property rights of third parties, and furthermore, the use of products in certain ways or in combination with Plessey, or non-Plessey furnished equipments/components may infringe intellectual property rights of Plessey.

The purpose of this document is to provide information only and it may not be used, applied or reproduced (in whole or in part) for any purpose nor be taken as a representation relating to the products in question. No warranty or guarantee express or implied is made concerning the capability, performance or suitability of any product, and information concerning possible applications or methods of use is provided for guidance only and not as a recommendation. The user is solely responsible for determining the performance and suitability of the product in any application and checking that any specification or data it seeks to rely on has not been superseded.

Products are intended for normal commercial applications. For applications requiring unusual environmental requirements, extended temperature range, or high reliability capability (e.g. military, or medical applications), special processing/testing/conditions of sale may be available on application to Plessey.

## Contact

Customer Support

+41752 693000 | [support@plesseysemi.com](mailto:support@plesseysemi.com)

[www.plesseysemi.com](http://www.plesseysemi.com)

Plessey Semiconductors Ltd | Plymouth  
Tamerton Road, Roborough  
Plymouth, Devon  
PL6 7BQ United Kingdom

Plessey Semiconductors Ltd | Swindon  
Design & Technology Centre, Delta  
500, Delta Business Park, Swindon  
SN5 7XE United Kingdom

P: +44 1752 693000  
F: +44 1752 693200

P: +44 1793 518000  
F: +44 1793 518030