AVR2016: RZRAVEN Hardware User's Guide

Features

- Development kit for the AT86RF230 radio transceiver and AVR® microcontroller.
- CE, ETSI and FCC approved.
- LCD module (AVRRAVEN):
 - AT86RF230 radio transceiver with high gain PCB antenna.
 - Dual AVR microcontrollers.
 - Dynamic Speaker and microphone.
 - Atmel Serial Dataflash®.
 - User IO section:
 - USART
 - GPIO
 - Relay Driver
 - Powered by battery or external supply:
 - 5V to 12V external supply.
- USB module (RZUSBSTICK):
 - AT86RF230 radio transceiver with miniature PCB antenna.
 - AVR microcontroller with integrated Full Speed USB interface.
 - External memory interface.

1 Introduction

The RZRAVEN is a development kit for the AT86RF230 radio transceiver and the AVR microcontroller. It serves as a versatile and professional platform for developing and debugging a wide range of RF applications; spanning from: simple point-to-point communication through full blown sensor networks with numerous nodes running complex communication stacks. On top of this, the kit provides a nice human interface, which spans from PC connectivity, through LCD and audio input and output.

Figure 1-1. The RZRAVEN Kit Modules

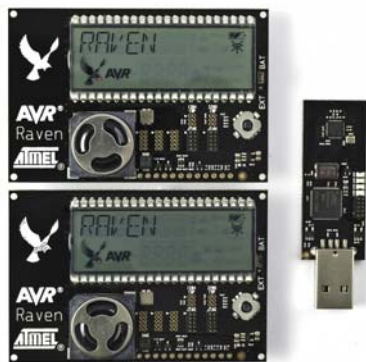

8-bit **AVR**[®]
Microcontrollers

Application Note

2 General

The RZRAVEN kit is built from one RZUSBSTICK module and two AVRRAVEN modules. See Figure 2-1 to Figure 2-4 for further details.

The complete schematics and Gerber files are available from the compressed archive accompanying this application note.

Figure 2-1 Assembly drawing AVRRAVEN - front view.

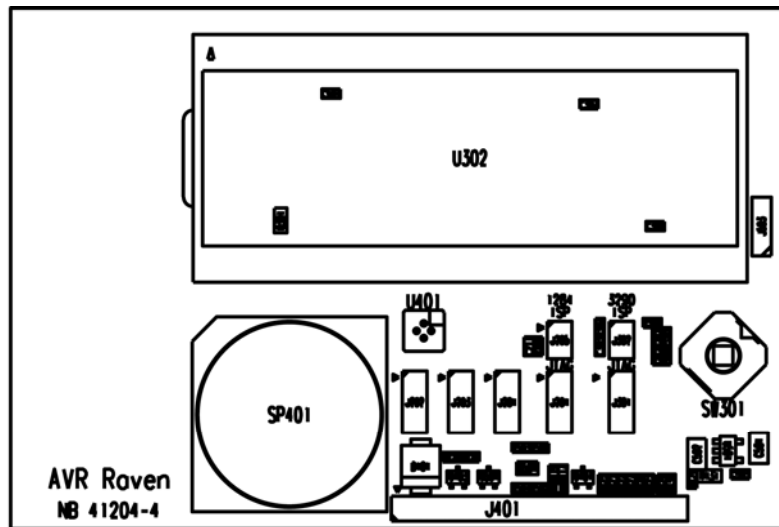

Figure 2-2 Assembly drawing AVRRAVEN - back view.

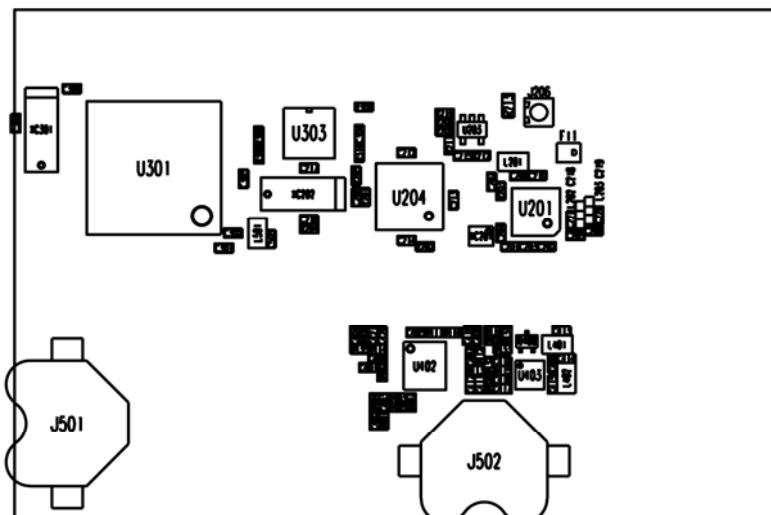

Figure 2-3 Assembly drawing RZRAVEN - front view.

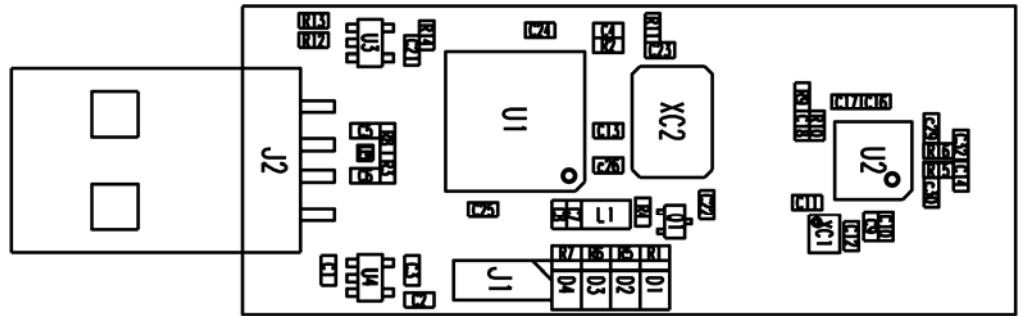
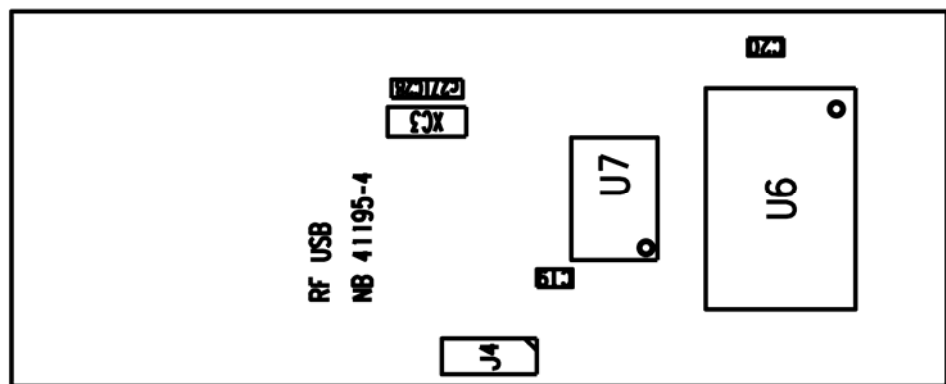

Figure 2-4 Assembly drawing RZRAVEN - back view



3 AVRRAVEN Module

The AVRRAVEN complete schematics may be found in Appendix A and Appendix D.

3.1 AVR Microcontrollers

Two AVR microcontrollers are found on the AVRRAVEN module. An ATmega1284P is connected to the AT86RF230 radio transceiver, and an ATmega3290P is driving the LCD. Both these devices are selected from the AVR picoPower family, something that ensures minimal power consumption and operation down to 1.8 Volts. Universal Synchronous and Asynchronous serial Receiver and Transmitter (USART) is used as an inter processor communication bus.

3.2 Atmel Radio Transceiver

The AT86RF230 is a 2.4GHz radio transceiver that is tailored for a wide range of wireless applications. Low power consumption and market leading RF performance makes it an excellent choice for virtually any type of networking device. Support for IEEE 802.15.4™ (Automatic acknowledge of packets, address filtering and automatic channel access) type of applications is available through an enhanced layer of functionality on top of the basic radio transceiver.



3.3 LCD

The LCD found on the AVRRAVEN module is a full custom 160-segment display tailored for the RZRAVEN kit (See Figure 3-1 for a quick reference). It contains a 7 segments text area; four segment number area and numerous handy symbols. In particular pay attention to the bird looking symbol. It is symbolizing the two black scouting ravens of Norse god Odin; Hugin (Thought) and Munin (Memory). The saga says that they flew around the world and reported news back to Odin at night. Underneath the raven segment's "eye" there is a red LED capable of soft-blinking; this may be used to indicate the AVRRAVEN's search for "news" on the air interface.

A full segment map can be found in Appendix C and in the schematics folder in the compressed archive file accompanying this application note. The LCD is driven directly from the connected ATmega3290P.

Figure 3-1 AVRRAVEN - LCD Segments

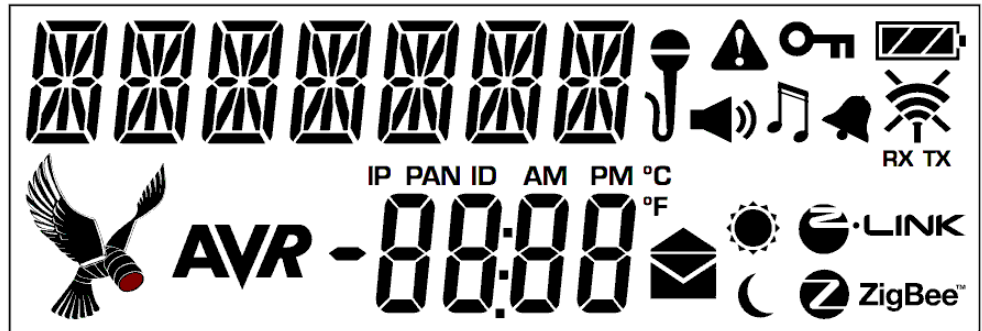

3.4 Speaker

An 8 Ω speaker is provided. The ATmega3290P controls all audio. The signal source is the TIMER1's PWM output and the signal is shaped via a low-pass filter and amplified by a Class-D amplifier. Pulling PORTE7 low activates the active filter and providing a PWM signal on PORTB5 activates the amplifier.

3.5 Microphone

The AVRRAVEN's microphone is connected to the ATmega3290P ADC channel 0. The signal is amplified and low-pass filtered. Pulling PORTE7 low activates the microphone circuit.

3.6 Serial Dataflash®

A 16-Mbits Atmel Serial Dataflash (AT45D161D) is connected to the ATmega3290P's Serial Peripheral Interface (SPI). This storage is used for safe firmware images, sounds and general-purpose parameters. See the firmware documentation for an overview of occupied sectors, and those available to the end user. Even with a couple of safe firmware images for the two microcontrollers there is plenty space left for the end user. Please note that the serial Dataflash will operate properly when the voltage is above 2.5 Volts while the rest of the design will operate down to 1.8Volts

3.7 Serial EEPROM

A 2-Kbits Atmel Serial EEPROM (AT24C02B) is connected to the ATmega1284P's two-wire interface (TWI). This storage is write protected by hardware and can only be read. The storage contains important configuration and calibration data that should not be unintentionally overwritten. Information such as a unique EUI 64-bit address can be found her-in. A rich set of access functions and the parameter map is given in the RZRAVEN firmware documentation.

3.8 Real Time Clock

Separate 32768 Hz clock crystals are connected to the ATmega3290P's and the ATmega1284P's asynchronous timer interfaces. This allows an application to implement a real time clock (RTC) to keep track of time when sleep modes are used to reduce the power consumption. This is especially important for battery-operated nodes.

3.9 NTC

A NTC is connected to the ATmega3290P's Analog to Digital Converter (ADC) channel 4. This NTC can be used to measure the temperature in the surroundings of the AVRRAVEN. The NTC can be found below the joystick, close to J401. The JTAG interface must be disabled when using the temperature sensor.

3.10 Power Supply

The AVRRAVEN can be powered either from batteries or an external 5 to 12 Volts DC source. The power source is selected by the position of the jumper located immediately to the right of the LCD (See the figure below for a reference). Polarity protection is provided when using an external power source.

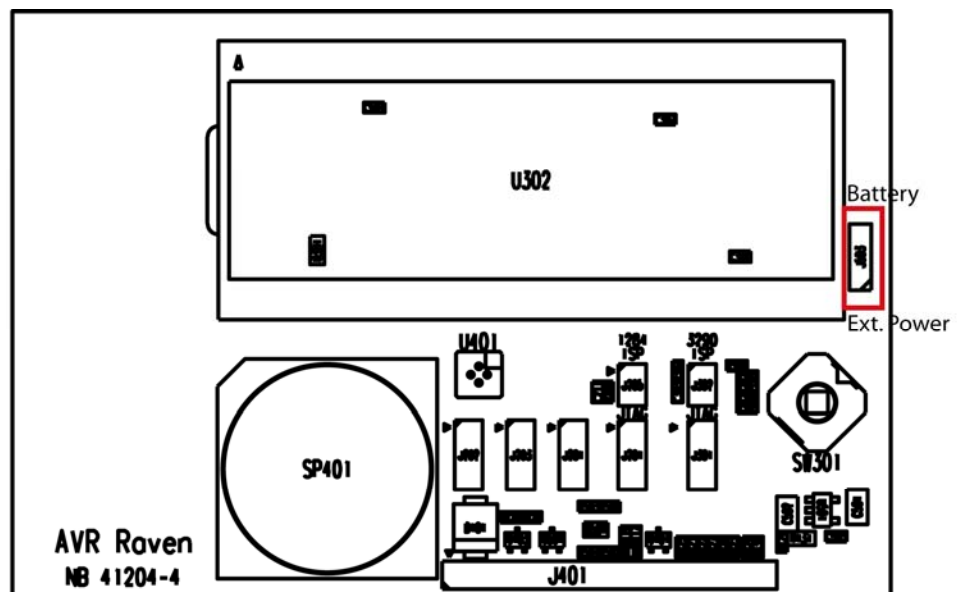



The AVRRAVEN has been designed to run from two 1.5V LR44 battery cells.

An onboard voltage regulator makes it possible to run power the AVRRAVEN from a 5 to 12 Volts DC source. The external voltage is applied to the two leftmost pins in the user IO area (J401). The ATmega3290P's ADC channel 2 is connected to a voltage divider and the external voltage supply interface. This way it is possible for the application to monitor the external operating voltage.

3.11 Interfaces

The AVRRAVEN module has multiple interfaces that can be used for serial communication, interaction with external sensors and control units such as relays and of course programming and debugging.

Figure 3-2 AVRRAVEN User Interfaces

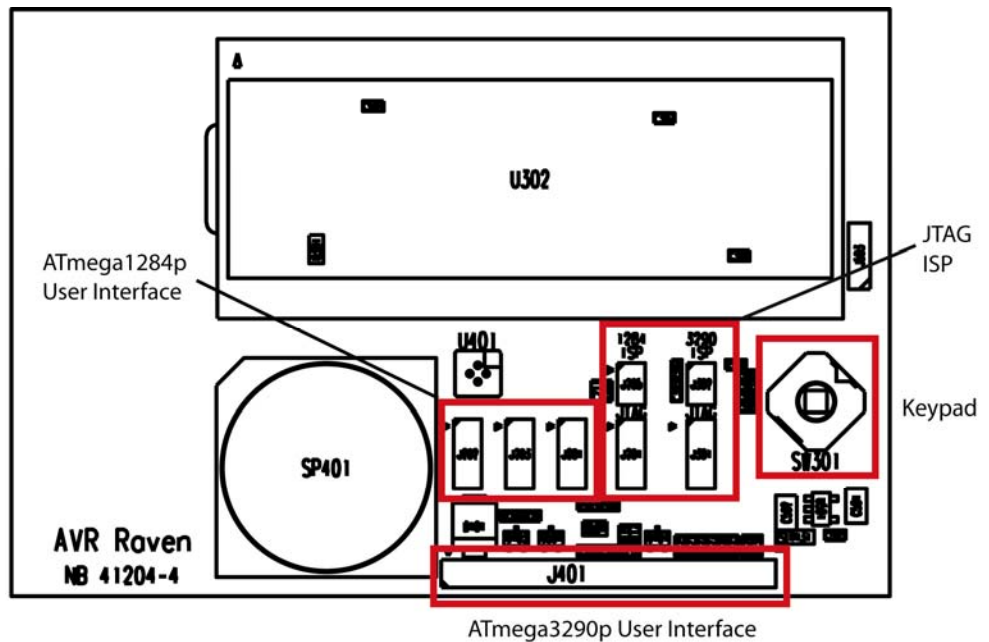

Table 3-1. Interfaces available on J401

Pin number	Function	Comment
1	Ext. power supply, 5-12V input	External power input
2	Ext. power supply 0V	Connected to internal 0V
3	Relay coil positive	Relay driver circuit pos.
4	Relay coil negative	Relay driver circuit neg.
5	Voltage measure input, 0-Vcc*5	Analog input via 47k/10k voltage divider
6	Voltage measure input, 0-Vcc	Analog input directly to ADC input.
7	Vcc	Connected to the VCC net directly
8	User IO #1	Digital I/O, may interface an LED or a switch directly. Internal 470Ω series resistor, and 10kΩ pull-ups are provided.
9	User IO #2	
10	User IO #3	

Pin number	Function	Comment
11	User IO #4	Pin change interrupts, TWI and USI is also available on these pins.
12	Common	Connected to internal 0V

Care should be taken when connecting to the AVRRAVEN's interfaces, since there is no protection circuitry provided. Damage to the MCUs or other circuits may be the result of ESD spark, short circuits, polarity or over-voltage faults.

3.11.1 Programming Interface

Both the ATmega3290P and ATmega1284P can be programmed using either the JTAG or ISP interface. JTAG programming can be facilitated by connecting a JTAG ICE mkII to the 50-mil pin header J301 (ATmega3290P) and J204 (ATmega1284P). A total of 5 50-mil pin headers and one 50-mil to 100-mil converter are supplied with the RZRAVEN kit.

ISP programming can be performed by connecting an ISP enabled AVR programming tool to the pin header J302 (ATmega3290P) and J205 (ATmega1284P). AVR tools like STK500, AVRISP mkII and JTAGICE mkII can be used for this.

The AVRRAVEN does not come with these headers mounted. So it is up to the user populating these. Wires could also be soldered in instead of the dual row headers.

3.11.2 Relay Interface

A relay interface (Relay Positive and Negative) is available through J401. This interface can be used with the AVRRAVEN running from external power. A switching transistor is connected to PB6 on the ATmega3290P so that sufficient current can be provided to the relay being driven. An external power source must be used if the relay option is required. The AVRRAVEN must then be supplied with the rated voltage of the relay.

3.12 Voltage Measurement Interface

Two of the pins in header J401 can be used for external voltage measurements, however only one at the time. The possible voltage ranges are 0 to VCC or via a voltage divider giving an approximate range of 0 to five times VCC. A simple voltage divider is implemented to scale the measurement voltage. A diode bridge is also used to prevent reverse polarity and to protect the ATmega3290P's ADC channel 3.

3.12.1 GPIO

Both the ATmega3290P and ATmega1284P are high pin count devices, and a number of these are not used. These pins are available through the user IO headers; J401, J201, J202 and J203. See Table 3-2 and Table 3-3 for further details.

Be aware that these pins do not have level converters and should thus not be connected directly to an application board running on a different voltage level than the AVRRAVEN.





Table 3-2. ATmega3290P User IO

ATmega3290P Port Pin	PCB Connection	Comment
PE3	J401 –8	Via 470Ω series resistor and 10kΩ pull-up
PE4	J401-9	Via 470Ω series resistor and 10kΩ pull-up
PE5	J401-10	Via 470Ω series resistor and 10kΩ pull-up
PE6	J401-11	Via 470Ω series resistor and 10kΩ pull-up

Table 3-3. ATmega1284P User IO

ATmega1284P Port Pin	PCB Connection	Comment
PC0	J201-1	TWI SCL. Connected to serial EEPROM
PC1	J201-2	TWI SDA. Connected to serial EEPROM
PC2	J201-3	JTAG TCK.
PC3	J201-4	JTAG TMS.
PC4	J201-5	JTAG TDO.
PC5	J201-6	JTAG TDI.
N.C.	J201-7	Populate R204 to connect to PC6. RTC Xtal XC202 must then be removed.
N.C.	J201-8	Populate R205 to connect to PC6. RTC Xtal XC202 must then be removed.
PD0	J202-1	RXD0 Inter processor communication.
PD1	J202-2	TXD0 Inter processor communication.
PD2	J202-3	DIO or RXD1.
PD3	J202-4	DIO or TXD1.
PD4	J202-5	DIO.
PD5	J202-6	DIO.
PB2	J202-7	DIO. NB: NOT PD6!
PD7	J202-8	DIO.
PA0	J203-1	DIO or ADC Channel 0.
PA1	J203-2	DIO or ADC Channel 1.
PA2	J203-3	DIO or ADC Channel 2.
PA3	J203-4	DIO or ADC Channel 3.
PA4	J203-5	DIO or ADC Channel 4.
PA5	J203-6	DIO or ADC Channel 5.
PA6	J203-7	DIO or ADC Channel 6.

ATmega1284P Port Pin	PCB Connection	Comment
PA7	J203-8	DIO or ADC Channel 7.
Additional interfaces		
External power	J201-10 J202-10 J203-10	Connected to J401-1
0V	J201-9 J202-9 J203-9	Connected to J401-2

4 RZUUSBSTICK Module

4.1 AVR Microcontroller

The AT90USB1287 is a device in the family of AVR microcontrollers with a low and full speed USB macro with device, host and On-the-go (OTG) capabilities.

4.2 Atmel Radio Transceiver

The AT86RF230 is a 2.4GHz radio transceiver that is tailored for a wide range of wireless applications. Low power consumption and market leading RF performance makes it an excellent choice for virtually any type of networking device. Support for IEEE 802.15.4 (Automatic acknowledge of packets, address filtering and automatic channel access) type of applications is available through an enhanced layer of functionality on top of the basic radio transceiver.

4.3 Interfaces

Figure 4-1 RZRAVEN Interfaces - front.

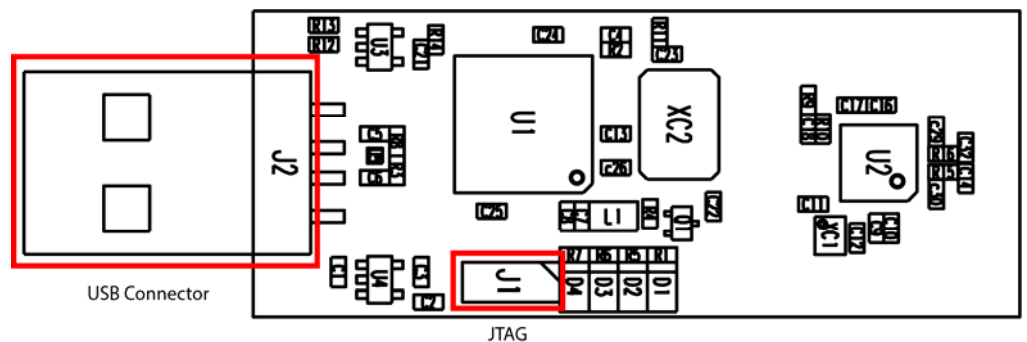
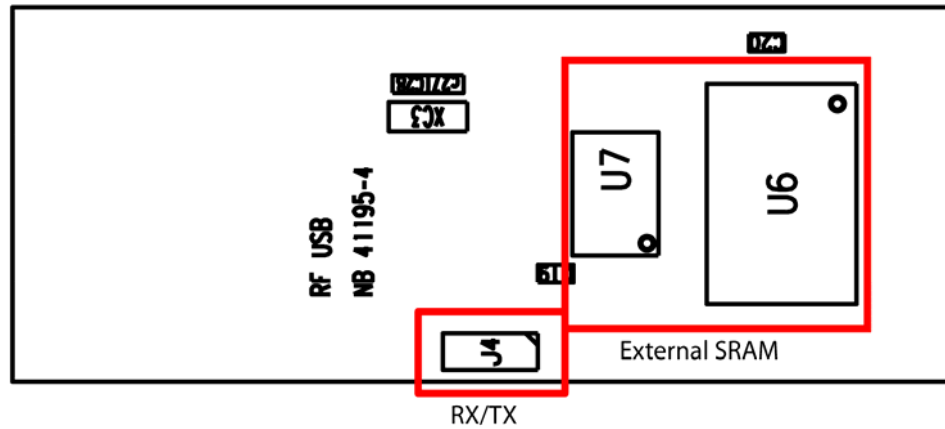



Figure 4-2 RZRAVEN Interfaces - back



4.3.1 External Memory Interface

When necessary the AT90USB1287's 8k Bytes of internal SRAM can be extended through the AVR external memory interface. The suggested external SRAM is 32k Bytes and is available from address 0x8000 to 0xFFFF giving a total of 40k Bytes when assembled.

Suggested latch and RAM:

- 74AHC573PW.
- BS62UV256TCP-10.

4.3.2 Serial Interface

The USART on the AT90USB1287 is routed to J4 on the RZRAVEN's backside. J4 is implemented as three large pads (RX-TX-GND) where the user can solder in wires and route the signal to his or her preference. The RX-TX signals are TTL level, so an external level converter must be connected if RS232 levels are necessary.

4.3.3 Programming Interface

A JTAG interface is provided for the AT90USB1287 microcontroller. The interface is available through a 50-mil spaced 10-pin dual row header. The RZRAVEN does not come with the header mounted. So it is up to the user populating it. Wires could also be soldered in instead of the dual row headers. A total of 5 50-mil pin headers and one 50-mil to 100-mil converter are supplied with the RZRAVEN kit.

4.3.4 LEDs

4 LEDs is assembled on the board:

Table 4-1. AT90USB1287 LEDs

LED	AT90USB1287 Port Pin	Comment
Blue (D1)	PORTD7	Turn LED on by pulling port pin high
Red (D2)	PORTD5	Turn LED on by pulling port pin low
Green (D3)	PORTE7	Turn LED on by pulling port pin low
Orange (D4)	PORTE6	Turn LED on by pulling port pin low

5 Appendix A: AVRRAVEN Schematics

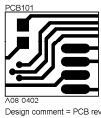
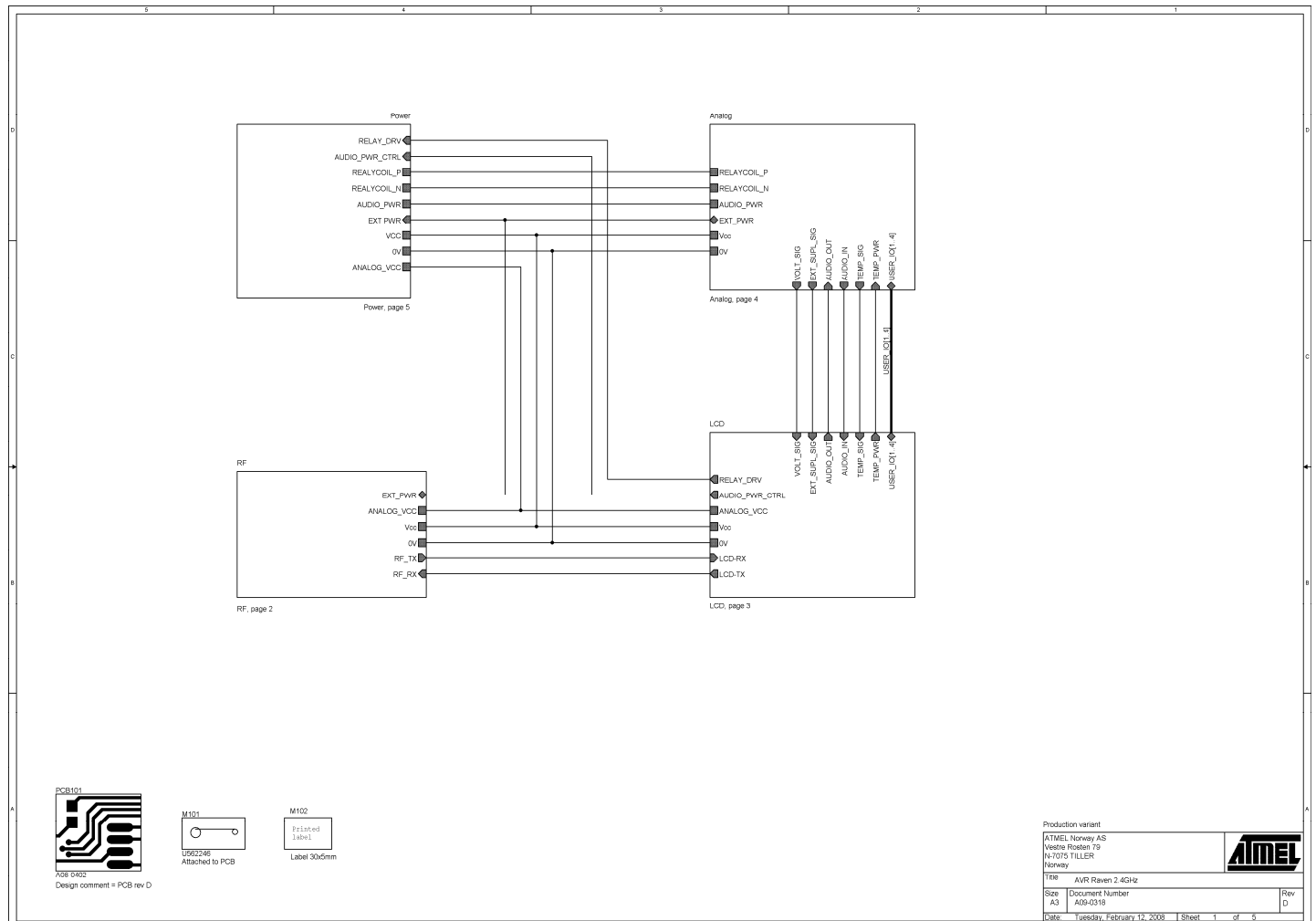

Production variant		
ATMEL Norway AS Vestre Rosten 79 N-17015 TILLER Norway		
TRN	AVR Raven 2 4Ghz	
Size	Document Number	Rev
A3	A09-0318	D
Date:	Tuesday, February 12, 2008	Sheet 1 of 5



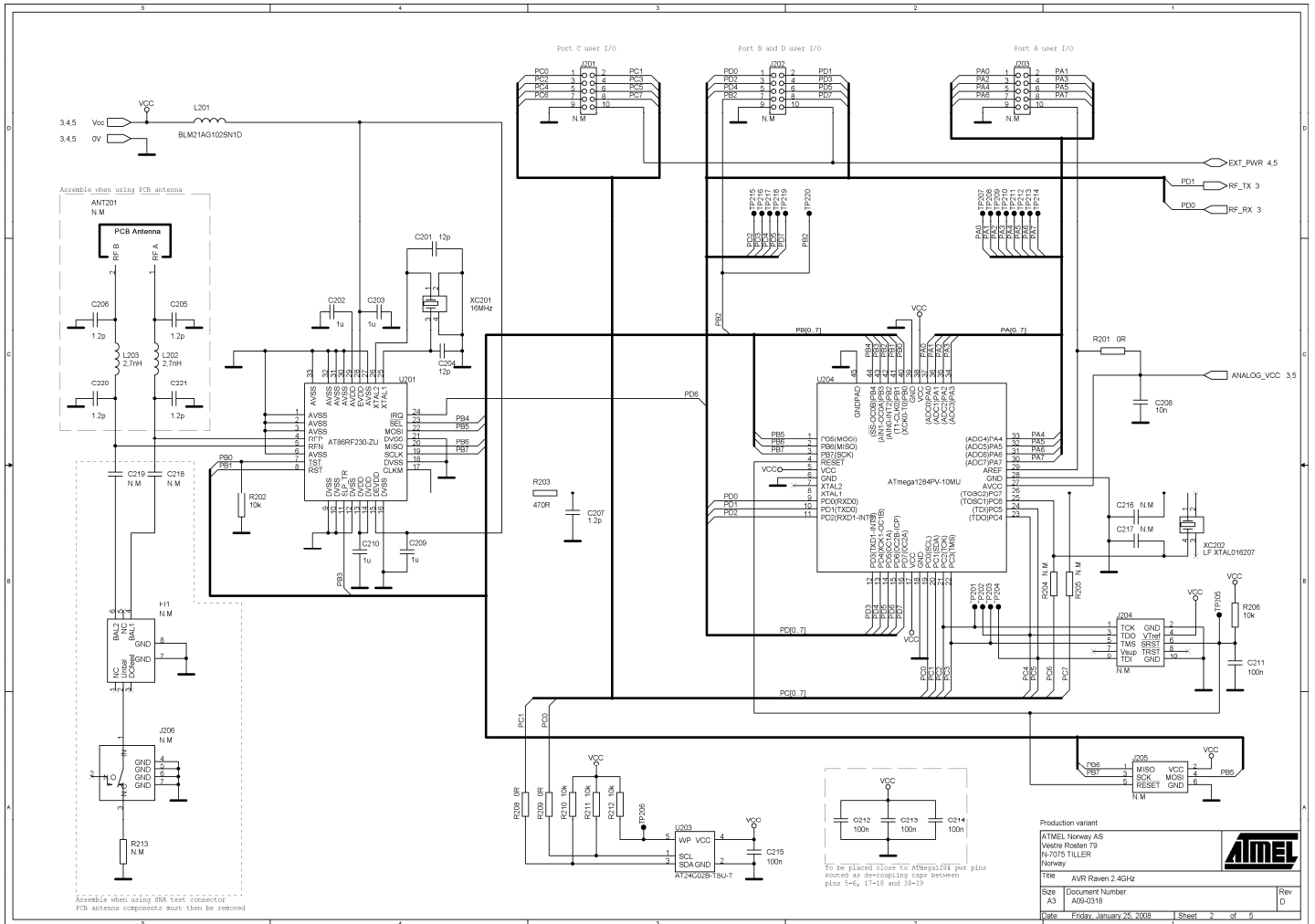

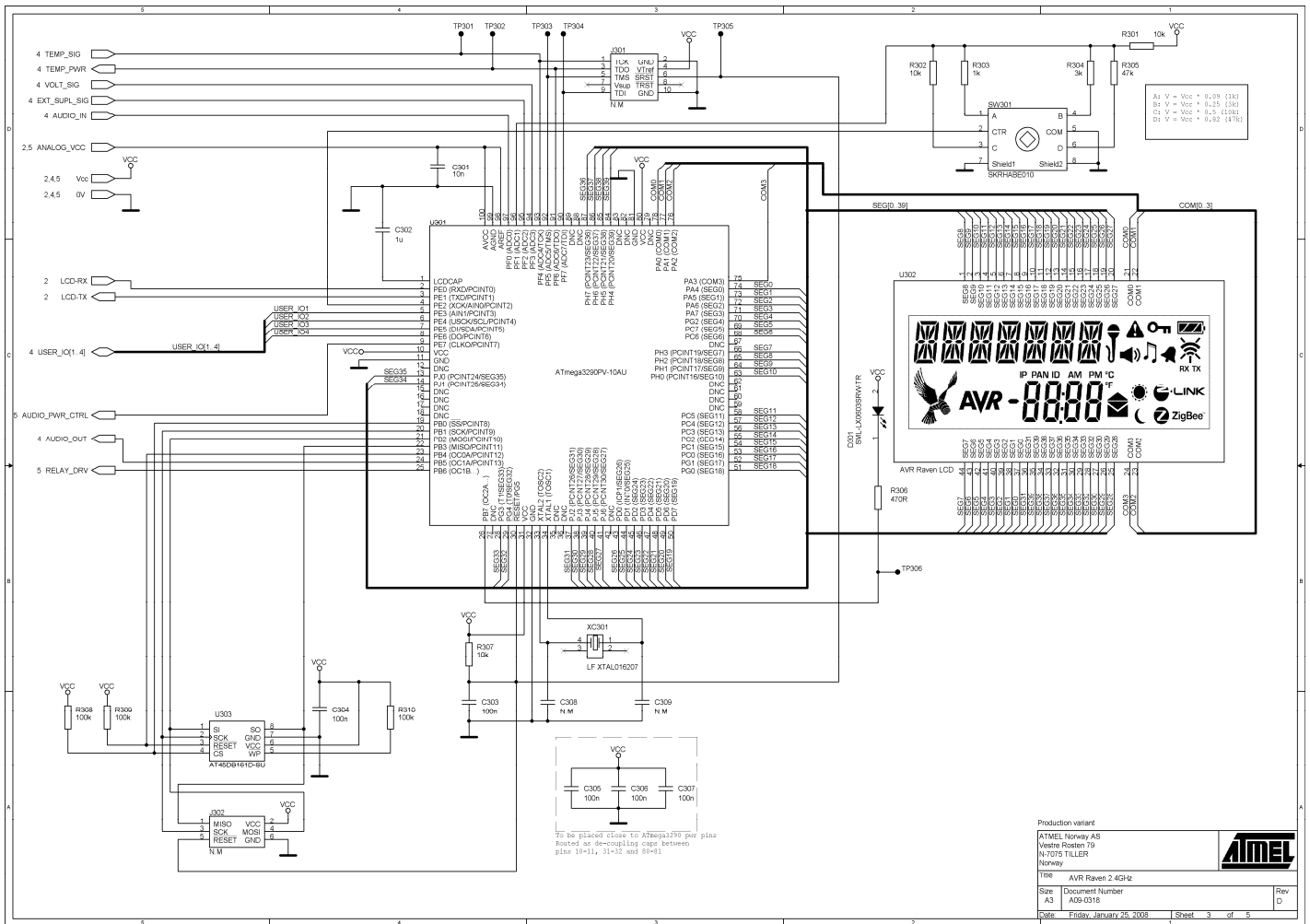

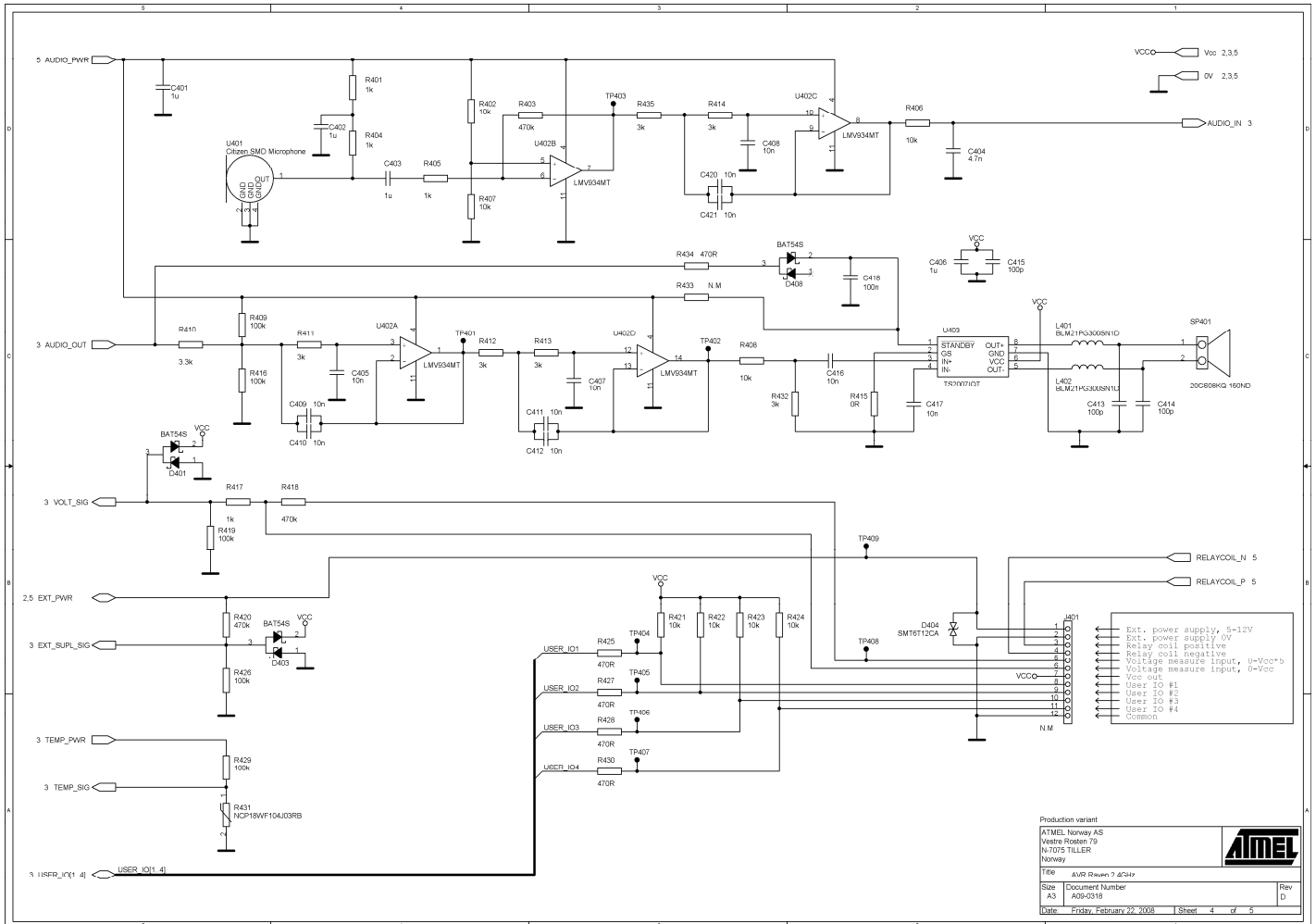

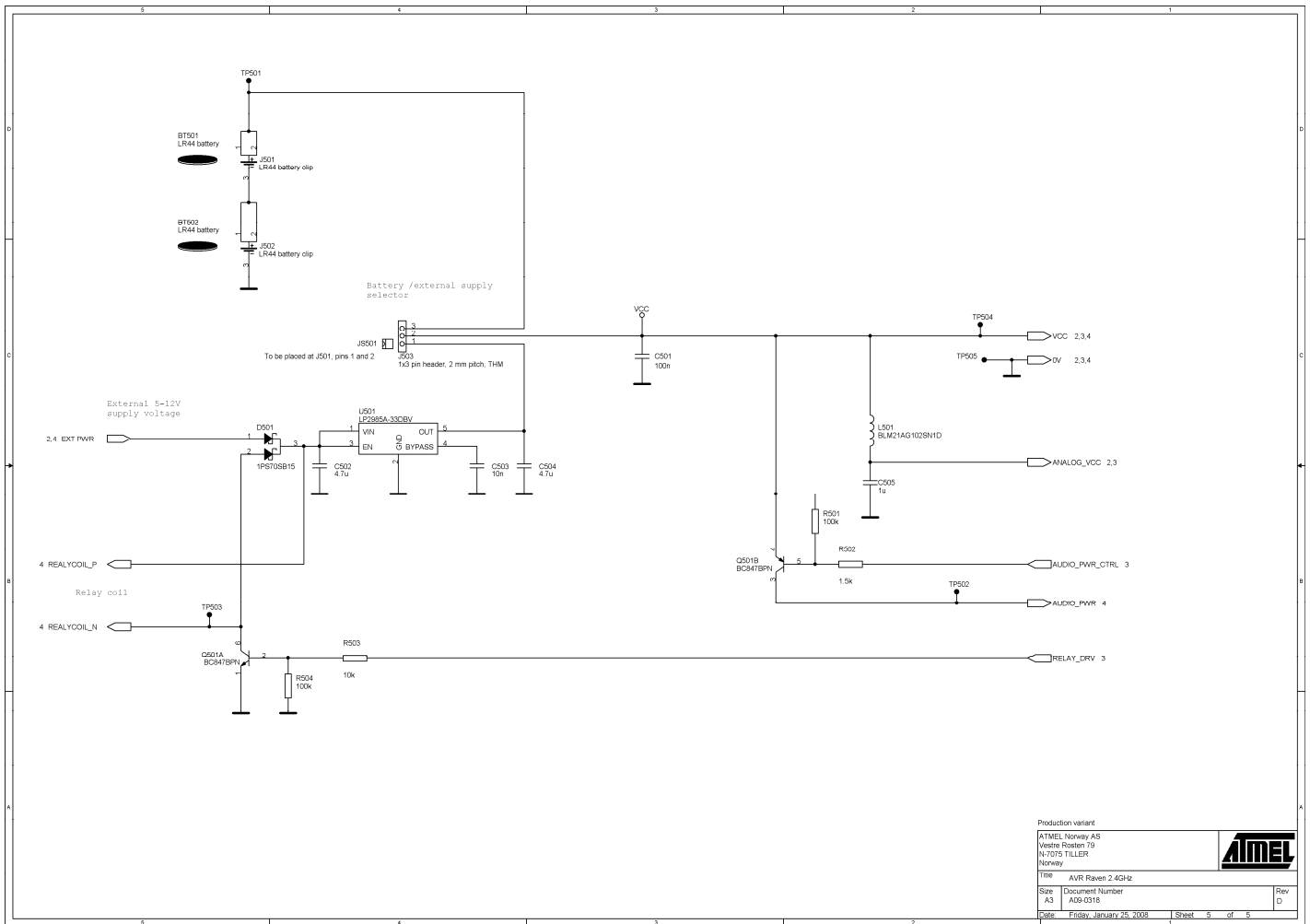



6 Appendix B: AVRRAVEN Bill of materials

Table 6-1. AVRRAVEN BOM

Qty	Designator	Description	Manufacturer	Part #
5	C205, C206, C207, C220, C221	Ceramic capacitor, SMD 0402, NP0, 50V, +/- 0.25pF		1.2p
2	C201, C204	Ceramic capacitor, SMD 0402, NP0, 50V, +/-5%		12p
3	C413, C414, C415	Ceramic capacitor, SMD 0402, NP0, 50V, +/-10%		100p
1	C404	Ceramic capacitor, SMD 0402, X7R, 25V, +/-10%		4.7n
14	C208, C301, C405, C407, C408, C409, C410, C411, C412, C416, C417, C420, C421, C503	Ceramic capacitor, SMD 0402, X7R, 25V, +/-10%		10n
2	C502, C504	Ceramic capacitor, SMD 0805, Y5V, 10V, -20/+80 %		4.7u
12	C211, C212, C213, C214, C215, C303, C304, C305, C306, C307, C418, C501	Ceramic capacitor, SMD 0402, X7R, 16V, +/-10%	Kemet	C0402C104K4RACTU
10	C202, C203, C209, C210, C302, C401, C402, C403, C406, C505	Ceramic capacitor, SMD 0402, X5R, 6.3V, +/-10%	Kemet	C0402C105K9PAC
4	R201, R208, R209, R415	Thick film resistor, SMD 0402, 1/16W, 1%		0R
7	R203, R306, R425, R427, R428, R430, R434	Thick film resistor, SMD 0402, 1/16W, 1%		470R
5	R303, R401, R404, R405, R417	Thick film resistor, SMD 0402, 1/16W, 1%		1k
1	R502	Thick film resistor, SMD 0402, 1/16W, 1%		1.5k
7	R304, R411, R412, R413, R414, R432, R435	Thick film resistor, SMD 0402, 1/16W, 1%		3k

Qty	Designator	Description	Manufacturer	Part #
1	R410	Thick film resistor, SMD 0402, 1/16W, 1%		3.3k
17	R202, R206, R210, R211, R212, R301, R302, R307, R402, R406, R407, R408, R421, R422, R423, R424, R503	Thick film resistor, SMD 0402, 1/16W, 1%		10k
1	R305	Thick film resistor, SMD 0402, 1/16W, 1%		47k
10	R308, R309, R310, R409, R416, R419, R426, R429, R501, R504	Thick film resistor, SMD 0402, 1/16W, 1%		100k
3	R403, R418, R420	Thick film resistor, SMD 0402, 1/16W, 1%		470k
1	R431	NTC Thermistor 100kOhm	Murata	NCP18WF104J03RB
2	L401, L402	SMD RF inductor 0805	Murata	BLM21PG300SN1D
2	L201, L501	SMD RF inductor 0805.	Murata	BLM21AG102SN1D
2	L202, L203	RF Inductor, 2.7nH, 0,17ohm, 300mA, 0402	Johanson Technology	L-07C2N7SV6T
3	D401, D403, D408	Dual schottky diode,	ST	BAT54SWFILM
1	D501	Dual Schottky diode,	Philips	1PS70SB15
1	D404	Bidirectional Transient suppression diode, 600W	ST	SM6T12CA
1	Q501	General purpose SMD BJT dual NPN-PNP	Philips	BC847BPN
1	U303	16-megabit 2.7-3.6 volt DataFlash	ATMEL	AT45DB161D-SU
1	U201	2.4GHz ZigBee/802.15.4 transceiver	ATMEL	AT86RF230-ZU
1	U203	2kbit Serial (TWI) EEPROM, AT24C02B, 1.8-5V	ATMEL	AT24C02B-TSU-T
1	U501	LDO 3.3V 150mA SOT23-5 (cer. cap)	Texas Instruments	LP2985A-33DBV
1	U402	LMV934MT 1V8 Quad	National Semiconductor	LMV934MT
1	U204	AVR 8-bit RISC MCU	ATMEL	ATmega1284PV-10MU
1	U301	AVR 8-bit RISC MCU	ATMEL	ATmega3290PV-10AU

Qty	Designator	Description	Manufacturer	Part #
1	U403	TS2007 3W class D audio amp.	ST	TS2007IQT
2	XC202, XC301	32.768kHz SMD crystal, 85SMX style	Rakon Ltd	LF XTAL016207
1	SP401	PC board speaker, SMD mount	Veco Vansonic	20CS08KQ-150ND
1	XC201	16MHz uXtal GSX-323, 2.0 x 2.5 mm SMD 10ppm	Golledge	GSX-323/111BF 16.0MHz
1	U401	Citizen 4.2x4.2mm SMD electric	Citizen	CHM-04C-03
1	SW301	ALPS 4-directional switch with center push function	ALPS	SKRHABE010
1	PCB101	AVR Raven PCB		A08-0402
2	J501, J502	LR44 battery clip, SMD	Keystone Corp.	2996TR
1	J503	1x3 pin header, 2 mm pitch, THM	SAMTEC	TMM-103-01-L-S
1	JS501	Jumper cap for 2.00mm pinheader	SAMTEC	2SN-BK-G
2	BT501, BT502	LR44 coin-cell battery		
1	D301	LED, Red, SMD 0603	Lumex	SML-LX0603SRW-TR
1	U302	AVR Raven LCD	Orient Display	0710091B

7 Appendix C: AVRRAVEN LCD

Figure 7-1 AVRRAVEN Segments

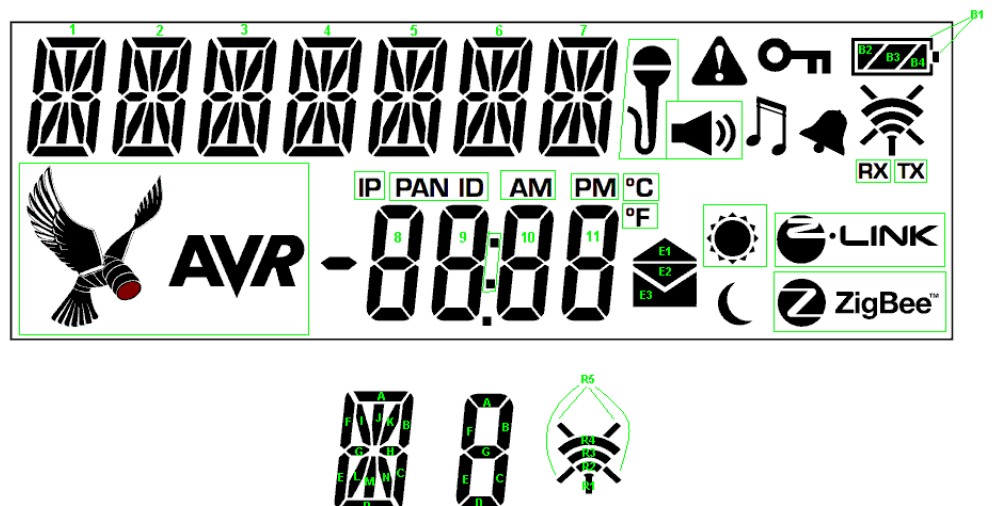
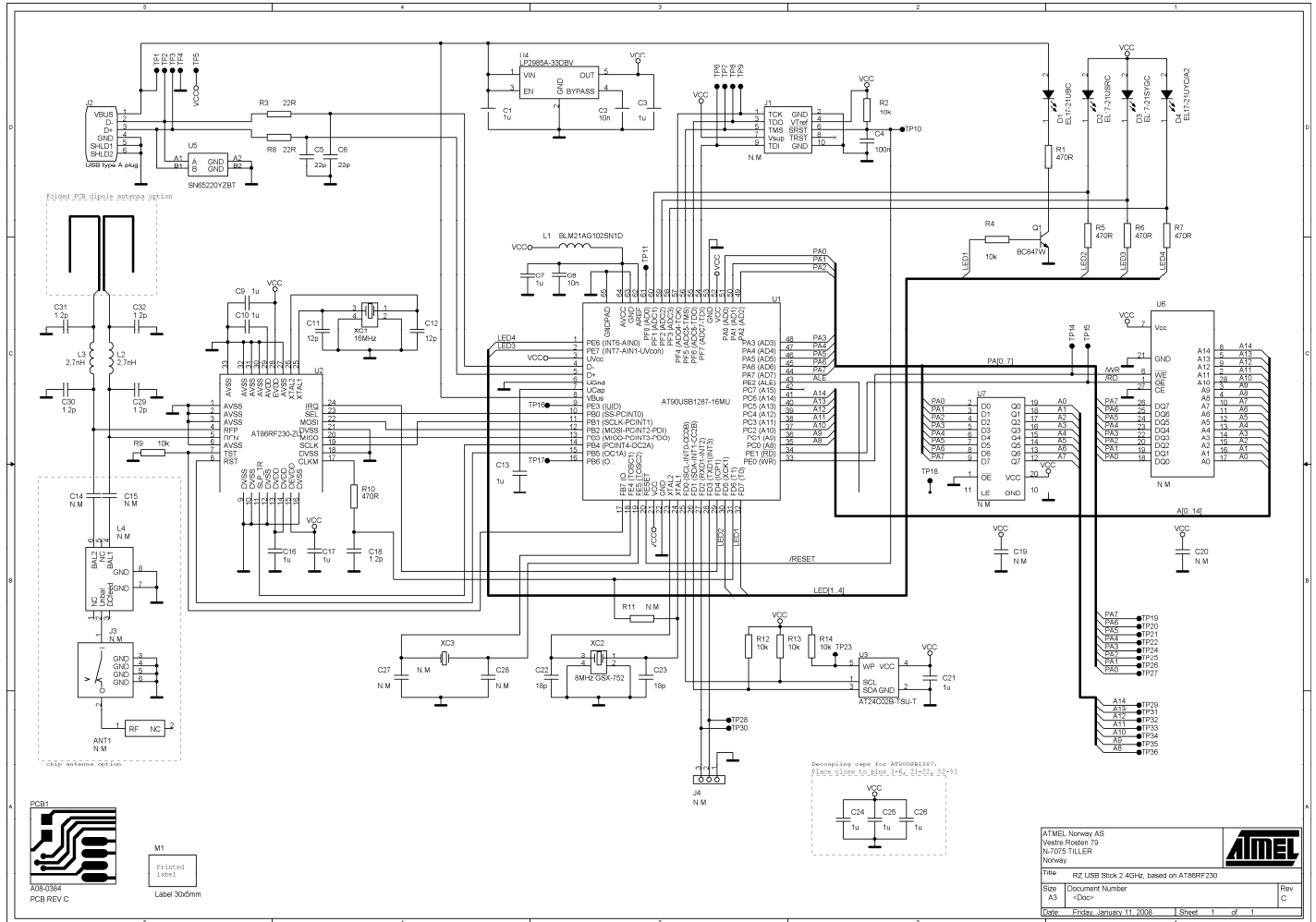

Table 7-1. LCD Segment description and mapping

Registers	Bit								COM
	7	6	5	4	3	2	1	0	
LCDDR19	SEG39 8A	SEG38 8B	SEG37 9A	SEG36 9B	SEG35 10A	SEG34 10B	SEG33 11A	SEG32 11B	COM3
LCDDR18	SEG31 PAN ID	SEG30 RX	SEG29 R1	SEG28 B1	SEG27 7C	SEG26 SPK	SEG25 7M	SEG24 7D	
LCDDR17	SEG23 6C	SEG22 TONE	SEG21 6M	SEG20 6D	SEG19 5C	SEG18 BELL	SEG17 5M	SEG16 5D	
LCDDR16	SEG15 4C	SEG14 °C	SEG13 4M	SEG12 4D	SEG11 3C	SEG10 °F	SEG9 3M	SEG8 3D	
LCDDR15	SEG7 2C	SEG6 PM	SEG5 2M	SEG4 2D	SEG3 1C	SEG2 AM	SEG1 1M	SEG0 1D	
LCDDR14	SEG39 8F	SEG38 8G	SEG37 9F	SEG36 9G	SEG35 10F	SEG34 10G	SEG33 11F	SEG32 11G	COM2
LCDDR13	SEG31 IP	SEG30 SUN	SEG29 TX	SEG28 B4	SEG27 7H	SEG26 7N	SEG25 7L	SEG24 7E	
LCDDR12	SEG23 6H	SEG22 6N	SEG21 6L	SEG20 6E	SEG19 5H	SEG18 5N	SEG17 5L	SEG16 5E	
LCDDR11	SEG15 4H	SEG14 4N	SEG13 4L	SEG12 4E	SEG11 3H	SEG10 3N	SEG9 3L	SEG8 3E	
LCDDR1	SEG7 2H	SEG6 2N	SEG5 2L	SEG4 2E	SEG3 1H	SEG2 1N	SEG1 1L	SEG0 1E	
LCDDR9	SEG39 8E	SEG38 8C	SEG37 9E	SEG36 9C	SEG35 10E	SEG34 10C	SEG33 11E	SEG32 11C	COM1
LCDDR8	SEG31 MINUS	SEG30 E1	SEG29 Z-LINK	SEG28 B3	SEG27 7B	SEG26 7K	SEG25 7J	SEG24 7G	
LCDDR7	SEG23 6B	SEG22 6K	SEG21 6J	SEG20 6G	SEG19 5B	SEG18 5K	SEG17 5J	SEG16 5G	
LCDDR6	SEG15 4B	SEG14 4K	SEG13 4J	SEG12 4G	SEG11 3B	SEG10 3K	SEG9 3J	SEG8 3G	
LCDDR5	SEG7 2B	SEG6 2K	SEG5 2J	SEG4 2G	SEG3 1B	SEG2 1K	SEG1 1J	SEG0 1G	
LCDDR4	SEG39 8D	SEG38 COLON	SEG37 9D	SEG36 POINT	SEG35 10D	SEG34 E3	SEG33 11D	SEG32 E2	COM0
LCDDR3	SEG31 RAVEN+AVR	SEG30 MOON	SEG29 Z_ZIGBEE	SEG28 B2	SEG27 MIC	SEG26 7A	SEG25 7I	SEG24 7F	
LCDDR2	SEG23 ATT!	SEG22 6A	SEG21 6I	SEG20 6F	SEG19 KEY	SEG18 5A	SEG17 5I	SEG16 5F	
LCDDR1	SEG15 R5	SEG14 4A	SEG13 4I	SEG12 4F	SEG11 R4	SEG10 3A	SEG9 3I	SEG8 3F	
LCDDR0	SEG7 R3	SEG6 2A	SEG5 2I	SEG4 2F	SEG3 R2	SEG2 1A	SEG1 1I	SEG0 1F	



8 Appendix D: RZUSBSTICK Schematics



9 Appendix E: RZUSBSTICK Bill of materials

Table 9-1. RZUSBSTICK BOM

Qt	Designator	Description	Manufacturer	Part #
1	C18	Ceramic capacitor, SMD 0402, NP0, 50V, +/- .25pF		1.5p
2	C11, C12	Ceramic capacitor, SMD 0402, NP0, 50V, +/-5%		12p
2	C22, C23	Ceramic capacitor, SMD 0402, NP0, 50V, +/-5%		18p
2	C5, C6	Ceramic capacitor, SMD 0402, NP0, 50V, +/-5%		22p
2	C2, C8	Ceramic capacitor, SMD 0402, X7R, 25V, +/-10%		10n
1	C4	Ceramic capacitor, SMD 0402, X7R, 16V, +/-10%	Kemet	C0402C104K4RACTU
12	C1,C10,C13,C16, C17,C21,C24, C25, C26, C3, C7, C9	Ceramic capacitor, SMD 0402, X5R, 6.3V, +/-10%	Kemet	C0402C105K9PAC
2	R15, R16	Thick film resistor, SMD 0402, 1/16W, 1%		0R
2	R3, R8	Thick film resistor, SMD 0402, 1/16W, 1%		22R
5	R1,R10,R5,R6,R7	Thick film resistor, SMD 0402, 1/16W, 1%		470R
6	R12, R13, R14, R2, R4, R9	Thick film resistor, SMD 0402, 1/16W, 1%		10k
1	L1	SMD RF inductor 0805.	Murata	BLM21AG102SN1D
1	Q1	General purpose NPN.	Philips	BC847W
1	U5	Transient Suppressor,	TI	SN65220YZBR
1	U1	AVR 8-bit RISC MCU with USB, QFN64 package	ATMEL	AT90USB1287-16MU
1	U2	2.4GHz ZigBee/802.15.4 transceiver	ATMEL	AT86RF230-ZU
1	U3	2kbit Serial (TWI) EEPROM, AT24C02B,	ATMEL	AT24C02B-TSU-T
1	U4	LDO 3.3V 150mA	TI	LP2985A-33DBV
1	XC1	16MHz uXtal GSX-323,	Golledge	GSX-323/111BF 16.0MHz
1	XC2	8.0MHz Xtal GSX-752	Golledge	GSX-752B/551EF 8MHz
1	PCB1	RZUSBStick PCB	ATMEL	A08-0384
1	J2	USB type A plug, SMD	SAMTEC	USB-AM-S-F-B-SM1-R
1	D2	LED, Red,	Everlight	EL17-21USRC
1	D3	LED, Green,	Everlight	EL17-21SYGC
1	D4	LED, Yellow,	Everlight	EL17-21UYC/A2
1	D1	LED, Blue,	Everlight	EL17-21UBC





10 Appendix F: Federal Communications Commission (FCC) Statement

10.1 FCC Statements

10.1.1 Compliance Statement (Part 15.19)

These devices comply with Part 15 of the FCC Rules. Operation is subject to the following two conditions:

1. These devices may not cause harmful interference, and
2. These devices must accept any interference received, including interference that may cause undesired operation.

10.1.2 Warning (Part 15.21)

Changes or modifications not expressly approved by Atmel Norway could void the user's authority to operate the equipment.

10.1.3 20 cm Separation Distance

To comply with FCC's RF exposure limits for general population/uncontrolled exposure, these devices must be installed to provide a separation distance of at least 20 cm between the antennas and all personnel and must not be co-located or operating in conjunction with any other antenna or transmitter.

10.2 OEM Responsibility if using these devices in a product

10.2.1 OEM Responsibility to the FCC Rules and Regulations

These devices (the AVRRaven and the RZUSBStick) have been certified per FCC Part 15 rules for integration into products without further testing or certification. To fulfill the FCC certification requirements the OEM of the devices must ensure that the information provided on the device label is placed on the outside of the final product. The devices are labeled with their own FCC ID Number. If the FCC ID is not visible when the device is installed inside another device, then the outside of the device into which the module is installed must also display a label referring to the enclosed module. This exterior label can use wording such as the following:

"Contains FCC ID: VW4RZUSBSTICK" if including the RZUSBStick or

"Contains FCC ID: VW4AVRRAVEN" if including the AVRRaven

The OEM of the devices must only use the supplied PCB trace antennas that have been certified with these devices. The OEM of the devices must test their final product configuration to comply with Unintentional Radiator Limits before declaring FCC compliance per Part 15 of the FCC rules.

11 Appendix G: Antenna descriptions

11.1 AVR Raven antenna description

The antenna on the AVR Raven is a loop antenna with a net peak gain of 5dB

11.2 RZ USB Stick antenna description

The antenna on the AVR Raven is a folded dipole antenna with a net peak gain of 0dB



12 Table of Contents

Features	1
1 Introduction	1
2 General	2
3 AVRRAVEN Module	3
3.1 AVR Microcontrollers.....	3
3.2 Atmel Radio Transceiver	3
3.3 LCD	4
3.4 Speaker	4
3.5 Microphone.....	4
3.6 Serial Dataflash®	4
3.7 Serial EEPROM.....	5
3.8 Real Time Clock	5
3.9 NTC	5
3.10 Power Supply	5
3.11 Interfaces.....	6
3.11.1 Programming Interface	7
3.11.2 Relay Interface	7
3.12 Voltage Measurement Interface	7
3.12.1 GPIO	7
4 RZUSBSTICK Module	9
4.1 AVR Microcontroller	9
4.2 Atmel Radio Transceiver	9
4.3 Interfaces.....	9
4.3.1 External Memory Interface	10
4.3.2 Serial Interface	10
4.3.3 Programming Interface.....	10
4.3.4 LEDs.....	10
5 Appendix A: AVRRAVEN Schematics	11
6 Appendix B: AVRRAVEN Bill of materials	16
7 Appendix C: AVRRAVEN LCD	18
8 Appendix D: RZUSBSTICK Schematics	20
9 Appendix E: RZUSBSTICK Bill of materials	21
10 Appendix F: Federal Communications Commission (FCC) Statement	22
10.1 FCC Statements.....	22
10.1.1 Compliance Statement (Part 15.19)	22
10.1.2 Warning (Part 15.21)	22

10.1.3 20 cm Separation Distance 22

10.2 OEM Responsibility if using these devices in a product 22

 10.2.1 OEM Responsibility to the FCC Rules and Regulations 22

11 Appendix G: Antenna descriptions 23

 11.1 AVR Raven antenna description 23

 11.2 RZ USB Stick antenna description 23

12 Table of Contents 24

Disclaimer 26





Headquarters

Atmel Corporation
2325 Orchard Parkway
San Jose, CA 95131
USA
Tel: 1(408) 441-0311
Fax: 1(408) 487-2600

International

Atmel Asia
Room 1219
Chinachem Golden Plaza
77 Mody Road Tsimshatsui
East Kowloon
Hong Kong
Tel: (852) 2721-9778
Fax: (852) 2722-1369

Atmel Europe
Le Krebs
8, Rue Jean-Pierre Timbaud
BP 309
78054 Saint-Quentin-en-
Yvelines Cedex
France
Tel: (33) 1-30-60-70-00
Fax: (33) 1-30-60-71-11

Atmel Japan
9F, Tonetsu Shinkawa Bldg.
1-24-8 Shinkawa
Chuo-ku, Tokyo 104-0033
Japan
Tel: (81) 3-3523-3551
Fax: (81) 3-3523-7581

Product Contact

Web Site
www.atmel.com

Technical Support
avr@atmel.com

Sales Contact
www.atmel.com/contacts

Literature Request
www.atmel.com/literature

Disclaimer: The information in this document is provided in connection with Atmel products. No license, express or implied, by estoppel or otherwise, to any intellectual property right is granted by this document or in connection with the sale of Atmel products. **EXCEPT AS SET FORTH IN ATMEL'S TERMS AND CONDITIONS OF SALE LOCATED ON ATMEL'S WEB SITE, ATMEL ASSUMES NO LIABILITY WHATSOEVER AND DISCLAIMS ANY EXPRESS, IMPLIED OR STATUTORY WARRANTY RELATING TO ITS PRODUCTS INCLUDING, BUT NOT LIMITED TO, THE IMPLIED WARRANTY OF MERCHANTABILITY, FITNESS FOR A PARTICULAR PURPOSE, OR NON-INFRINGEMENT. IN NO EVENT SHALL ATMEL BE LIABLE FOR ANY DIRECT, INDIRECT, CONSEQUENTIAL, PUNITIVE, SPECIAL OR INCIDENTAL DAMAGES (INCLUDING, WITHOUT LIMITATION, DAMAGES FOR LOSS OF PROFITS, BUSINESS INTERRUPTION, OR LOSS OF INFORMATION) ARISING OUT OF THE USE OR INABILITY TO USE THIS DOCUMENT, EVEN IF ATMEL HAS BEEN ADVISED OF THE POSSIBILITY OF SUCH DAMAGES.** Atmel makes no representations or warranties with respect to the accuracy or completeness of the contents of this document and reserves the right to make changes to specifications and product descriptions at any time without notice. Atmel does not make any commitment to update the information contained herein. Unless specifically provided otherwise, Atmel products are not suitable for, and shall not be used in, automotive applications. Atmel's products are not intended, authorized, or warranted for use as components in applications intended to support or sustain life.

© 2008 Atmel Corporation. All rights reserved. Atmel®, logo and combinations thereof AVR®, STK®, and others, are the registered trademarks or trademarks of Atmel Corporation or its subsidiaries. Other terms and product names may be trademarks of others.